

Lewin's Circuit Paradox

Kirk T. McDonald

Joseph Henry Laboratories, Princeton University, Princeton, NJ 08544

(May 7, 2010; updated November 14, 2018)

1 Problem

W. Lewin of MIT has popularized an example of a deceptively simple circuit with somewhat paradoxical behavior [1].^{1,2,3,4} As sketched below, a loop containing resistors R_1 and R_2 surrounds a solenoid magnet⁵ that is excited by a time-dependent current.

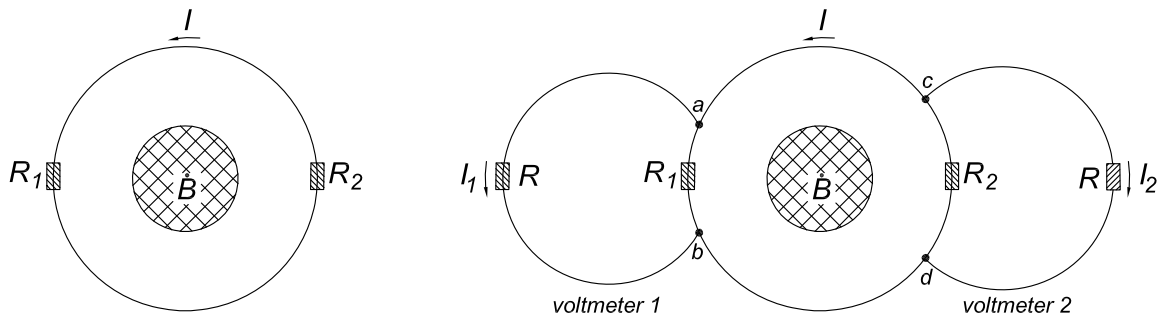

This circuit is probed by two voltmeters as sketched in the righthand figure above. Each voltmeter consists of a resistor $R \gg R_1, R_2$ and an ammeter that measures the (generally time-dependent) currents I_i and reports the “voltage” $V_{\text{meter},i}(t) = I_i(t)R_i$.⁶ The “positive” leads of the voltmeters are connected to points a and c , such that the directions of currents I_1 and I_2 are as shown when positive.

The paradox is that $V_{\text{meter}1}$ does not equal $V_{\text{meter}2}$, which is particularly surprising in the case that points a and c are the same, and points b and d are the same.

Discuss.

2 Solution

This problem has a long history in pedagogic lore, some of which can be traced in [7]-[27]. A position sensor base on the principles of this problem is described in [28].

¹<https://www.youtube.com/watch?v=nGQbA2jwkWI>

²May 1, 2018: A video that illustrates much of the analysis of this note is

<https://youtu.be/JpVoT101Azg> by Cyriel Mabilde. Explicit mention of this note begins at time 20:40.

³Aug. 26, 2019: An online article by Paul Rako on this controversy is at

<https://www.electronicdesign.com/analog/when-kirchhoff-s-law-doesn-t-work>

⁴Another example of the delicacy of “ordinary” circuit analysis is the two-capacitor paradox [2].

⁵Nominally, the axes of the solenoid magnet and the circular loop are the same.

⁶The ambiguous meaning of “voltage” is noted, for example, in [3]. A general discussion of what AC voltmeters measure is given in [4], and the concepts of “voltage drop” and \mathcal{EMF} are reviewed in [5, 6].

2.1 Analysis via Kirchoff's Circuit Laws

A circuit diagram for the system is shown below. The solenoid magnet is the primary of a transformer that is excited by a time-dependent current I_p which is assumed to be known. The loop with resistors R_1 and R_2 is the secondary of the transformer. The (small) self inductance of the secondary is L , and $M \gg L$ is the mutual inductance between the primary and secondary.

Kirchoff's circuit (loop) equation [29, 30] was originally only for DC circuits with batteries (of "electromotive force" \mathcal{E}) and resistors (R), and can be expressed as that the sum of the (scalar) "voltage drops" around any loop is zero. This was extended by Maxwell [31, 32, 33]⁷ to include coupled, time-dependent circuits, at rest, with capacitors (C), coils/inductors (L , M), and electric generators (AC voltage sources \mathcal{E}),

$$0 = \sum_{\text{loop}} \text{voltage drops} = \sum_i I_i R_r + \sum_j \left(\dot{I}_j L_j + \sum_k \dot{I}_k M_{jk} \right) + \sum_l Q_l / C_l - \sum_m \mathcal{E}_m. \quad (1)$$

Kirchoff's (extended) loop equation (1) does not apply to all possible circuits, and gives a poor description of circuits whose size is not small compared to relevant wavelengths, in which effects of radiation and retardation can be important.⁸ Examples such as Lewin's in which the self inductance of the entire loop could be important must be treated with care.

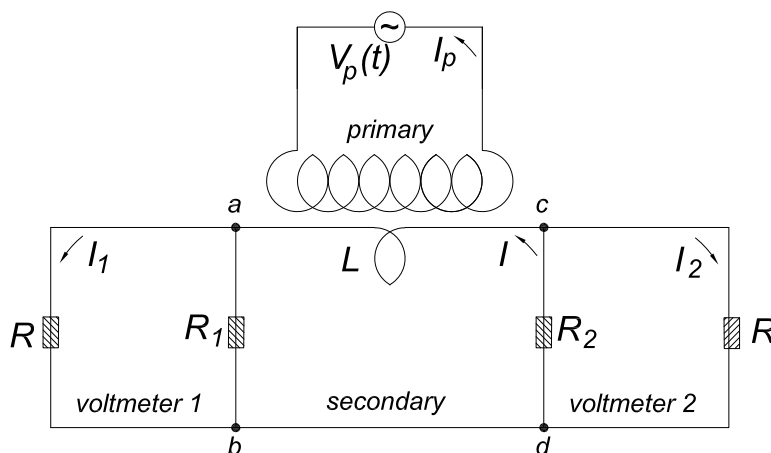

Kirchoff's loop equation for the central (secondary) loop in Lewin's example is,⁹ for the secondary loop is,

$$0 = (I - I_1)R_1 + (I + I_2)R_2 + L\dot{I} + M\dot{I}_p. \quad (2)$$

⁷See also the Appendix below.

⁸For a review of the limitations of Kirchoff's loop equation, see [5].

⁹Lewin has supplemented his circuit paradox with YouTube videos titled "Kirchoff's Loop Rule is for the Birds," https://www.youtube.com/watch?v=LzT_YZ0xCFY, and "Is Kirchoff's Loop Rule for the Birds?" https://www.youtube.com/watch?v=5be3zpj_eCY. Since Kirchoff's loop equation is based on conservation of energy, as reviewed in the Appendix below, many of the statements in these videos are more in the nature of misdirection than explanation.

Lewin has also supplemented his lectures with two notes [34, 35], where it is claimed that Kirchoff's (2nd) circuit law is that $\oint_{\text{loop}} \mathbf{E} \cdot d\mathbf{l} = 0$ for any circuit loop, rather than the more standard version, eq. (1), for (coupled) R - L - C circuits. Of course, use of an obsolete version of a "law" can lead to apparent paradoxes.

An important consideration in Lewin's example (not mentioned by Lewin) is that the term $L\dot{I}$ is negligible compared to $M\dot{I}_p$, *i.e.*, the effect of the self inductance L is small compared to that of the mutual inductance M with the primary circuit, whose current I_p is large compared to I . We define the \mathcal{EMF} (electromotive force),¹⁰

$$\mathcal{E} = -M\dot{I}_p = -\dot{\Phi}_p, \quad (3)$$

where Φ_p is the magnetic flux from the primary through the secondary loop. Then, eq. (2) can be written as,

$$\mathcal{E} = (R_1 + R_2)I + R_1I_1 - R_2I_2. \quad (4)$$

Similarly, Kirchhoff's equations for the voltmeter loops are,

$$0 = I_1R + (I_1 - I)R_1 \approx RI_1 - R_1I, \quad (5)$$

$$0 = I_2R + (I_2 + I)R_2 \approx RI_2 + R_2I. \quad (6)$$

Solving the three simultaneous linear equations (4)-(6) for the currents, we find,

$$I \approx \frac{\mathcal{E}}{R_1 + R_2}, \quad I_1 \approx \mathcal{E} \frac{R_1}{R(R_1 + R_2)}, \quad I_2 \approx -\mathcal{E} \frac{R_2}{R(R_1 + R_2)}, \quad (7)$$

in the (good) approximations that $R_1, R_2 \ll R, I_1, I_2 \ll I$. The meter readings are therefore,

$$V_{\text{meter1}} = I_1R \approx \mathcal{E} \frac{R_1}{R_1 + R_2}, \quad V_{\text{meter2}} = I_2R \approx -\mathcal{E} \frac{R_2}{R_1 + R_2}. \quad (8)$$

which have opposite signs, and obey $|V_{\text{meter1}}| + |V_{\text{meter2}}| = \mathcal{E}$.

The meter readings do not depend on the locations of points a, b, c and d , so long as a and c are both between resistors R_1 and R_2 on the upper wire between them, and b and d are both between resistors R_1 and R_2 on the lower wire between them, and the leads are connected in the sense of the figure on the left below (from [17]).¹¹

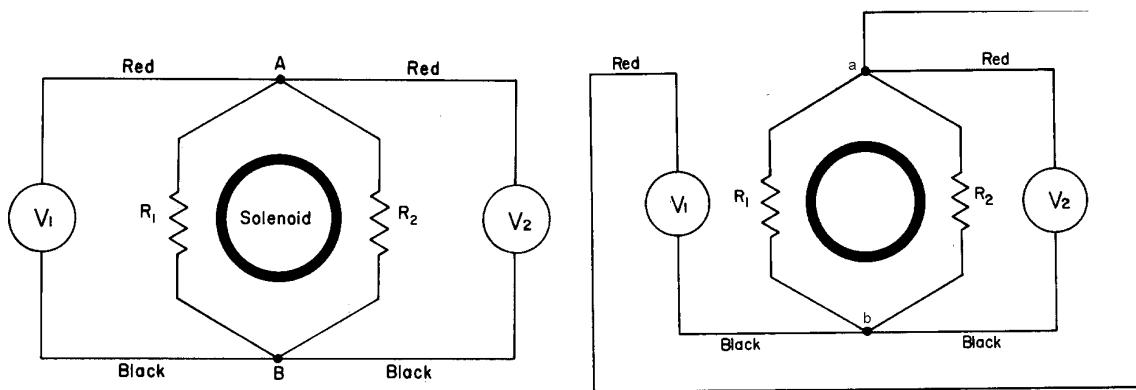

These results were validated by experiment during Lewin's lecture demonstration.

¹⁰The \mathcal{EMF} (3) is time dependent in general, although in some demonstrations it is nearly constant for a short time.

¹¹If the solenoid is "short", the voltmeter loops can intercept the return magnetic flux which affects the voltmeter readings. As indicated in the video cited in footnote 2, this issue can be avoided by minimizing the area of the voltmeter loops.

However, if both meters were outside the secondary loop and their leads both attached to that loop from its “right” side as shown in the figure on the right above, both meters would read $-\mathcal{E}R_2/(R_1 + R_2)$, while if all leads were attached from the “left” side they would both read $\mathcal{E}R_1/(R_1 + R_2)$.

2.1.1 Which Way Does Current I_1 Go Around the Secondary Loop?

In the preceding analysis we tacitly assumed that the current I_1 flows only on the left side of the secondary loop between points a and b , as shown on the left in the figure below.

But it could be that the current flowed on the right side of the secondary loop, as shown on the right in the figure below. In this case Kirchhoff’s law for the secondary loop is,

$$\mathcal{E} = IR_1 + (I + I_1)R_2 \approx (R_1 + R_2)I, \quad (9)$$

while Kirchhoff’s law for the voltmeter loop is,

$$\mathcal{E} = I_1R + (I_1 + I)R_2 \approx RI_1 + R_2I, \quad (10)$$

noting that now all the magnetic flux in the solenoid is linked by the voltmeter loop. Solving eqs. (9)-(10) for the currents we find,

$$I = \frac{\mathcal{E}}{R_1 + R_2}, \quad I_1 = \mathcal{E} \frac{R_1}{R(R_1 + R_2)}, \quad (11)$$

as found in eq. (7) assuming that current I_1 flowed on the left side of the secondary loop.

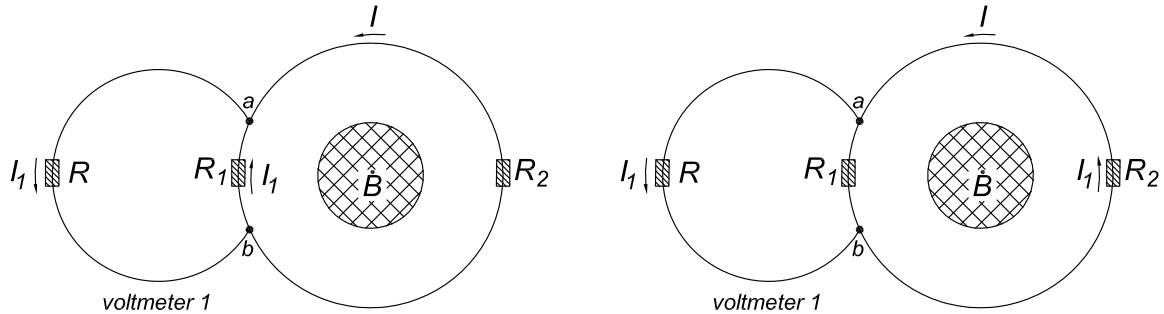

Hence, the value of the current I_1 does not depend on whether it flowed on the left or on the right side of the secondary loop, and the circuit analysis based on Kirchhoff’s law cannot determine the partitioning of current I_1 between the left and right sides.

However, the amount of heat dissipated in resistors R_1 and R_2 depends on the partitioning of current I_1 between them. We suppose that the partition minimizes the heat dissipation.¹² Defining f to be the fraction of current I_1 that passes through resistor R_1 , the power dissipated in the two resistors is,

$$P = (I - fI_1)^2R_1 + [I + (1 - f)I_1]^2R_2 = P_0 - 2fII_1(R_1 + R_2) - 2fI_1^2R_2 + f^2I_1^2(R_1 + R_2), \quad (12)$$

where $P_0 = I^2(R_1 + R_2)$ is independent of f . On minimizing the power P we find that,

$$f = \frac{I}{I_1} + \frac{R_2}{R_1 + R_2} \gg 1. \quad (13)$$

Since f cannot be larger than 1, we infer that $f = 1$, and all the current I_1 flows through resistor R_1 as initially assumed.

¹²Here, we follow Heaviside, p. 303 of [36].

2.1.2 The Voltmeter Leads Pass Through the Interior of the Secondary Loop

Suppose the voltmeter leads cross the interior of the secondary loop, such that a fraction f of the magnetic flux of the solenoid passes through the voltmeter loop, as shown in the sketches below.

As discussed in sec. 2.1.1, it suffices to suppose that all of current I_1 passes through resistor R_1 . Then, Kirchoff's law for the secondary loop is,

$$\mathcal{E} = (I - I_1)R_1 + IR_2 = I(R_1 + R_2) + I_1R_1 \approx I(R_1 + R_2), \quad (14)$$

while Kirchoff's law for the voltmeter loop is,

$$-f\mathcal{E} = I_1R + (I_1 - I)R_1 \approx I_1R - IR_1, \quad (15)$$

noting that the sense of current I_1 is opposite to that of current I , such that the \mathcal{EMF} which drives the voltmeter loop is $-f\mathcal{E}$. Solving eqs. (14)-(15) for the currents we find,

$$I = \frac{\mathcal{E}}{R_1 + R_2}, \quad I_1 = \mathcal{E} \frac{R_1 - f(R_1 + R_2)}{R(R_1 + R_2)}. \quad (16)$$

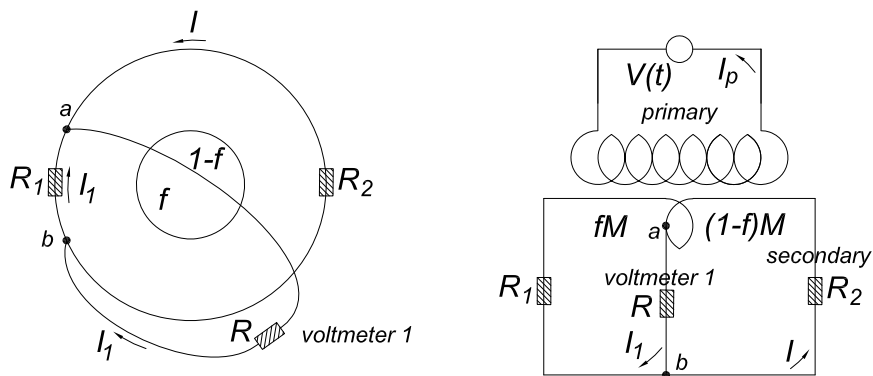

The limiting cases for the current I_1 are,

$$I_1(f = 0) = \mathcal{E} \frac{R_1}{R(R_1 + R_2)}, \quad I_1(f = 1) = -\mathcal{E} \frac{R_2}{R(R_1 + R_2)}, \quad (17)$$

which correspond to the previous results, eq. (7), for the voltmeter on the “left” and on the “right”, respectively. Thus, there is a continuum of possible readings of the voltmeter between the “left” and “right” readings, depending on the routing of the voltmeter leads.

2.2 Scalar and Vector Potentials¹³

The fact that the two meters give different readings when $a = c$ and $b = d$ (in sec. 2.1) indicates that the meter readings are not simply proportional to the electric scalar potential V at those points, as would be the case for a DC circuit.

In DC circuit analysis, ideal conductors (such as we have tacitly assumed all wires in the system to be) are equipotentials. However, in time-dependent circuit analysis the proper

¹³The author thanks Trevor Kearney for comments on this section.

assumption is that the electric field tangential to the wires is zero (in the limit of perfectly conducting wires).

In time-dependent situations, such as the present example, the electric field \mathbf{E} is related to both the scalar potential V as well as to the vector potential \mathbf{A} according to,¹⁴

$$\mathbf{E} = -\nabla V - \frac{\partial \mathbf{A}}{\partial t} \equiv \mathbf{E}_V + \mathbf{E}_A. \quad (18)$$

Supposing that the secondary loop is circular, with radius r , its tangential component E_ϕ is given by,

$$E_\phi = -\frac{1}{r} \frac{\partial V}{\partial \phi} - \frac{\partial A_\phi}{\partial t} = E_{V,\phi} + E_{A,\phi}. \quad (19)$$

Since $\mathbf{B} = \nabla \times \mathbf{A}$, we have from Stoke's theorem that $\oint \mathbf{A} \cdot d\mathbf{l} = \int \mathbf{B} \cdot d\mathbf{Area} = \Phi_B$, so the azimuthal component A_ϕ if the vector potential is given by,

$$A_\phi(r, t) = \frac{\Phi_p(t)}{2\pi} \begin{cases} \frac{1}{r} & (r > r_B), \\ \frac{r}{r_B^2} & (r < r_B), \end{cases} \quad (20)$$

where the magnetic flux Φ_B is approximated as uniform within a cylinder of radius r_B that is less than the radius of the secondary loop.¹⁵ In the present example the magnetic flux Φ through the secondary loop has contributions from the magnetic fields due to all four currents I_p , I , I_1 and I_2 . Of these only the contribution Φ_p from the primary current I_p is significant. Thus, the electric field associated with the changing vector potential is,

$$\mathbf{E}_A = E_{A,\phi} \hat{\phi} = -\frac{\partial A_\phi}{\partial t} \hat{\phi} = -\frac{\dot{\Phi}_p}{2\pi r} \hat{\phi} = \frac{\mathcal{E}}{2\pi r} \hat{\phi}, \quad (21)$$

recalling eq. (3).

We now consider the wire segments in the central loop, of radius $r_s > r_B$, inside which $E_\phi = 0$ (in the approximation of perfectly conducting wires). There, eq. (19) tells us that,

$$\frac{\partial V(r_s, \phi)}{\partial \phi} = -r_s \frac{\partial A_\phi}{\partial t} = -\frac{\dot{\Phi}_p}{2\pi} = \frac{\mathcal{E}}{2\pi}, \quad (22)$$

and so the scalar potential along a wire segment has the form,

$$V(r_s, \phi) = \mathcal{E} \frac{\phi}{2\pi} + \text{const}, \quad (23)$$

¹⁴In the present example, both V and \mathbf{E}_V are functions of time, and hence are **not** (electro)static (unless the magnetic flux Φ_p through the primary circuit varies exactly linearly with time).

Of course, we could to set the scalar potential V to zero everywhere (which is "electrostatic"), as first noted by Gibbs [37, 38, 39].

In this note, we will work in the Coulomb gauge, where $\nabla \cdot \mathbf{A} = 0$, and the scalar potential is formally related by $V(\mathbf{x}, t) = \int \rho(\mathbf{x}', t) d\text{Vol}' / |\mathbf{x} - \mathbf{x}'|$, which is the instantaneous static potential. Thus, a nonzero scalar potential V requires a nonzero electric charge distribution ρ , which is often neglected in analysis of circuits without capacitors, as in Lewin's example. However, the surfaces of the conductors do have nonzero electric surface charge [40]-[53], to shape the electric fields inside them, although it is not convenient to deduce this charge density and compute the scalar potential from it.

¹⁵We assume here that the (primary) magnetic flux Φ_B is centered on the secondary circuit.

where ϕ increases for counterclockwise movement around the loop.

Inside a resistor, the electric field $\mathbf{E} = \mathbf{E}_V + \mathbf{E}_A$ is related to the current density \mathbf{J} by Ohm's law, $\mathbf{J} = \sigma\mathbf{E}$, where σ is the electrical conductivity. Assuming that the radius of a resistor is small compared to the radius r_s of the secondary loop, the current density and the electric field are azimuthal, and constant. Since the field \mathbf{E}_A is also azimuthal and constant (at a fixed radius r) according to eq. (21), it follows that the field \mathbf{E}_V is also azimuthal and constant inside a resistor of the secondary loop. The voltage drop¹⁶ across a resistor is therefore of the form $\Delta V = E_V r_s \alpha$, where angle α is azimuthal extent of the resistor.

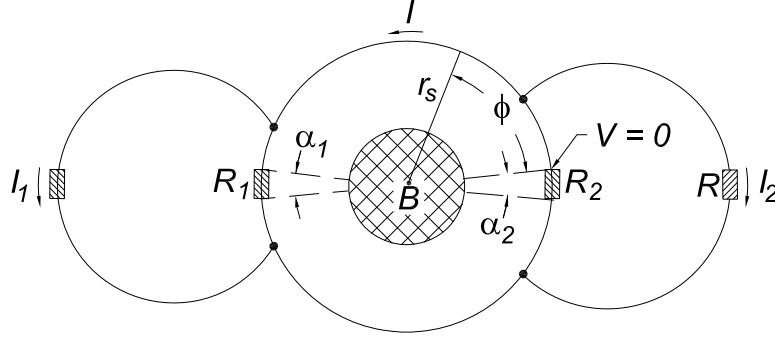

Resistor i has resistance $R_i = r_s \alpha_i / \sigma_i A_i$, where α_i is its azimuthal extent, A_i is its cross-sectional area, and σ_i is its conductivity. The current in each resistor R_i is I to a good approximation (since $I \gg I_1$ and I_2), so the current density is $J_i \approx I/A_i$, and Ohm's law can be written as,

$$\frac{I}{A_i} \approx J_i = \sigma_i (E_{V,i} + E_A) = \sigma_i \left(\frac{\Delta V_i}{r_s \alpha_i} + \frac{\mathcal{E}}{2\pi r_s} \right), \quad \frac{I r_s \alpha_i}{\sigma_i A_i} = I R_i \approx \Delta V_i + \mathcal{E} \frac{\alpha_i}{2\pi}. \quad (24)$$

The magnitudes of the voltage drops across resistors R_1 and R_2 are,

$$\Delta V_1 \approx I R_1 - \mathcal{E} \frac{\alpha_1}{2\pi} \approx \mathcal{E} \frac{R_1}{R_1 + R_2} - \mathcal{E} \frac{\alpha_1}{2\pi}, \quad \Delta V_2 \approx I R_2 - \mathcal{E} \frac{\alpha_2}{2\pi} \approx \mathcal{E} \frac{R_2}{R_1 + R_2} - \mathcal{E} \frac{\alpha_2}{2\pi}. \quad (25)$$

The voltage drops (25) equal the meter readings (8) (in magnitude) only if the azimuthal extents α_i of the resistors are very small.¹⁷

If we define the scalar potential V to be zero at $\phi = 0$ which is the azimuth of the “top” of resistor R_2 , as in the figure above, then resistor 1 extends from $\phi = \phi_1$ to $\phi_1 + \alpha_1$, resistor 2 extends from $\phi_2 = 2\pi - \alpha_2$ to 2π , and the scalar potential on the secondary loop is,

$$V(r_s, 0 < \phi < \phi_1) = \mathcal{E} \frac{\phi}{2\pi}, \quad (26)$$

$$V(r_s, \phi_1 < \phi < \phi_1 + \alpha_1) = \mathcal{E} \frac{\phi_1}{2\pi} - \Delta V_1 \frac{\phi - \phi_1}{\alpha_1} = \mathcal{E} \frac{\phi}{2\pi} - \mathcal{E} \frac{R_1}{R_1 + R_2} \frac{\phi - \phi_1}{\alpha_1}, \quad (27)$$

$$V(r_s, \phi_1 + \alpha_1 < \phi < 2\pi - \alpha_2) = \mathcal{E} \frac{\phi_1}{2\pi} - \Delta V_1 + \mathcal{E} \frac{\phi - \phi_1 - \alpha_1}{2\pi} = \mathcal{E} \frac{\phi}{2\pi} - \mathcal{E} \frac{R_1}{R_1 + R_2}, \quad (28)$$

¹⁶In this note we use the term **voltage drop** to mean the difference in the electric scalar potential V between two points. Calling those points a and b , the voltage drop between them is $\Delta V = V_a - V_b$. In Lewin's example, a meter reading, V_{meter} , does not equal the voltage drop between the tips of its leads, as will be confirmed below.

¹⁷This was the case in the video linked in footnote 2.

$$\begin{aligned}
V(r_s, 2\pi - \alpha_2 < \phi < 2\pi) &= \mathcal{E} \frac{2\pi - \alpha_1 - \alpha_2}{2\pi} - \Delta V_1 - \Delta V_2 \frac{\phi - 2\pi + \alpha_2}{\alpha_2} \\
&= \mathcal{E} \frac{\phi}{2\pi} - \mathcal{E} \frac{R_1}{R_1 + R_2} - \mathcal{E} \frac{R_2}{R_1 + R_2} \frac{\phi - 2\pi + \alpha_2}{\alpha_2}. \quad (29)
\end{aligned}$$

The potential at $\phi = 2\pi$ is

$$V(r_s, 2\pi) = \mathcal{E} - \mathcal{E} \frac{R_1}{R_1 + R_2} - \mathcal{E} \frac{R_2}{R_1 + R_2} = 0, \quad (30)$$

as expected.

Finally, the voltage drops between the points where the voltmeters are attached to the central, secondary loop are, using eqs. (26) and (28),

$$V_a - V_b \approx \mathcal{E} \frac{\phi_a}{2\pi} - \mathcal{E} \frac{\phi_b}{2\pi} + \mathcal{E} \frac{R_1}{R_1 + R_2} = -\mathcal{E} \frac{\phi_{ab}}{2\pi} + \mathcal{E} \frac{R_1}{R_1 + R_2}, \quad (31)$$

$$V_c - V_d \approx \mathcal{E} \frac{\phi_c}{2\pi} - \mathcal{E} \frac{\phi_d}{2\pi} + \mathcal{E} \frac{R_1}{R_1 + R_2} = \mathcal{E} \frac{\phi_{cd}}{2\pi} - \mathcal{E} + \mathcal{E} \frac{R_1}{R_1 + R_2} = \mathcal{E} \frac{\phi_{cd}}{2\pi} - \mathcal{E} \frac{R_2}{R_1 + R_2}, \quad (32)$$

in the convention that $\phi_{ab} = \phi_b - \phi_a$ and $\phi_{cd} = \phi_c + 2\pi - \phi_d$ are both positive.

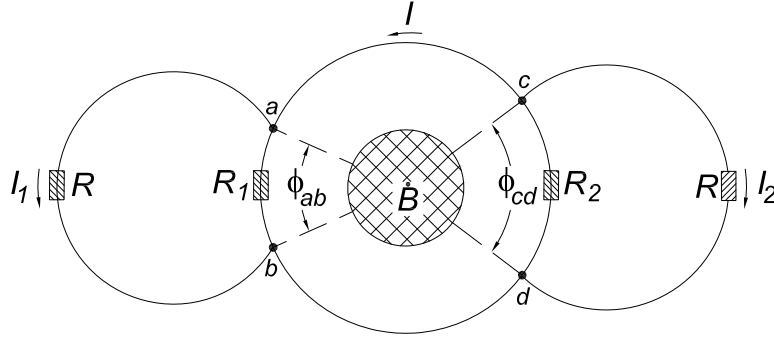

Only if the meter leads were connected directly to the ends of resistors R_1 and R_2 (as would be good practice), and the resistor have negligible azimuthal extent, would the meter readings (8) equal the voltage differences (differences in the electric scalar potential) between the tips of the leads.^{18,19}

2.2.1 Secondary Loop of Resistive Wire (updated May 23, 2022)

In two early statements [9, 10] of the present problem, resistors 1 and 2 were not localized objects. Rather, the secondary loop was made of a single resistive wire of total resistance R_0 . Then, the current I in the loop would be \mathcal{E}/R_0 . In this case, the IR drop between points a and b that subtend angle ϕ_{ab} is $IR_0 \phi_{ab}/2\pi = \mathcal{E} \phi_{ab}/2\pi$, which is what a voltmeter would read if connected to points a and b (with leads outside the secondary loop).

¹⁸If the meter leads cross the region of magnetic flux from the solenoid, intercepting fraction f of that flux as in sec. 2.1.2, there is always a set of points $\{a, b\}$ such that the meter reading equals $V_a - V_b$. In particular, if $f = 1/2$ the desired points are halfway between the two resistors, as noted in [16]. However, in these cases the meter leads cannot be short.

¹⁹For additional examples of the relation of voltmeter readings to the scalar and vector potentials in time-varying situations, see [4].

However, in this case the scalar potential V is zero (in the Coulomb gauge).²⁰ That is, the electric field inside (and outside) the resistive wire is entirely associated with the vector potential, and is entirely azimuthal, $\mathbf{E} = -(\partial A_\phi/\partial t)\hat{\phi}$. In this special case, no surface charge is needed on the wire to shape the electric field inside it.²¹

2.2.2 On the “Reality” of the Vector Potential

The example of a long solenoid (or toroid) with “zero” magnetic field, but nonzero vector potential, outside the coil, is often used to argue that the vector potential (or at least differences in the vector potential) should be considered as “real” (*i.e.*, having measurable effect). The best known of the arguments is the quantum example of Aharonov and Bohm [54], although this independently restates an earlier argument by Ehrenberg and Siday [55]. A related argument for classical electrodynamics has been given by Konopinski [56]; see also [57, 58].

The classical argument is weaker, being that the electric field outside the solenoid with a time-varying current is due to the magnetic field inside the solenoid according to Faraday’s law, but the magnetic field is “zero” outside the solenoid, so this effect appears to be action at a distance. Since field theory was developed with the goal of eliminating action at a distance, it seems that the “local” result,

$$\mathbf{E}_{\text{induced}} = -\frac{\partial \mathbf{A}}{\partial t}, \quad (33)$$

implies that we should consider the vector potential to be “real”. However, as noted by Lodge in 1889 [7], the magnetic field outside the solenoid is not strictly zero, and we can argue that the weak time-varying magnetic field outside the solenoid “creates” the induced electric field there.²²

The quantum argument seems stronger, in that even for a static magnetic field in the solenoid, there is a detectable effect on the trajectories of electrons that pass outside the solenoid [54, 55]. Independent of the skepticism expressed in articles such as [61], the author notes that the supposedly “real” vector potential in the examples of Lewin, and of Aharonov and Bohm, is the gauge-invariant rotational part of the vector potential,²³ which is the total vector potential in the Coulomb gauge.²⁴ This vector potential includes terms that depend on the instantaneous current distribution throughout the Universe, *i.e.*, it incorporates action at a distance. The author’s attitude is that any quantity which involves action at a distance is not physically “real”,²⁵ and hence even the “gauge-invariant” part of the vector potential

²⁰To use eqs. (27) and (29) for a resistive wire, set $R_1 = R_2 = R_0/2$, $\alpha_1 = \pi = \alpha_2$, $\phi_1 = 0$ and $\phi_2 = \pi$. Then, $\Delta V_1 = 0 = \Delta V_2$ from eq. (25), and both eqs. (27) and (29) give $V(\phi) = 0$ (while eqs. (26) and (28) do not apply to a resistive wire loop).

²¹These points were made somewhat obliquely in [9], where it was also noted that they do not hold if the time-dependent magnetic flux Φ_p is off-center with respect to the resistive wire loop.

²²In greater detail, weak radiation fields exist outside a time-varying solenoid (and toroid), which must be considered in a full classical description. See, for example, [57, 59, 60].

²³See, for example, sec. 2.1 of [62].

²⁴Strictly, the irrotational part of the vector potential is not unique, being subject to so-called restricted gauge transformations. See p. 4 of [62].

²⁵The wave function of nonrelativistic quantum mechanics is such a quantity, and thus not “real” in the author’s view.

should not be regarded as “real”.²⁶

2.3 Comments

Suppose a voltmeter were connected to two points on the upper wire between resistors 1 and 2, as shown in the sketch below. The voltmeter loop is not coupled to the solenoid, so there is no (or extremely little) \mathcal{EMF} induced in this loop, and hence $I_1 = 0$, and the meter reading would be $V_{\text{meter}} = 0$.

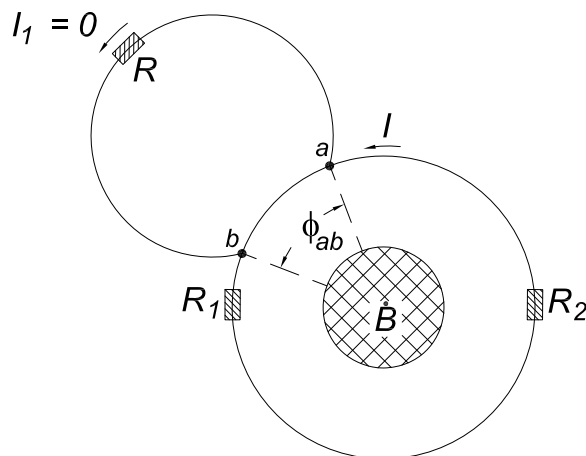

However, the difference between the scalar potential at points a and b is, recalling eq. (23),

$$V_a - V_b \approx \mathcal{E} \frac{\phi_{ab}}{2\pi}, \quad (34)$$

where ϕ_{ab} is the azimuthal angle between the two points. While the meter does not read the difference in the scalar potential between the tips of its leads, the result $V_{\text{meter}} = 0$ is appealing in that we might naïvely expect the “voltage drop” to be zero between points along a good/perfect conductor.

This leads some people to argue that the term “voltage drop” should not be defined as the (unique) difference in the scalar potential V between two points (as done in this note), but rather this term should have only the operational meaning as the value measured by a voltmeter when connected to those two points. While possibly appealing in examples such as the present, this usage renders the concept of “voltage drop” to be more a property of the voltmeter (and the routing of its leads) than of the circuit it probes. See [4] for further discussion.

In the present example,

$$V_{\text{meter}} = \int_a^b \mathbf{E} \cdot d\mathbf{l}_{\text{leads}} = - \int_a^b \mathbf{E} \cdot d\mathbf{l}_{\text{loop containing } R_1 \text{ and } R_2}. \quad (35)$$

While some people designate the integral $\int_a^b \mathbf{E} \cdot d\mathbf{l}$ as a “voltage drop”, we advocate calling this the \mathcal{EMF} between points a and b , and that the “voltage drop” between points a and b be reserved to mean simply $V_a - V_b$, the difference in the scalar potential between the two points [64].

²⁶The Aharonov-Bohm effect involves action at a distance in terms of the vector potential as well as the fields if one uses the Poincaré gauge [63].

A Appendix: Kirchhoff's Circuit Laws

In 1845, Kirchhoff (age 21) gave his circuit laws [29, 30] for a network of batteries and resistors, as a generalization of Ohm's law (1827) [65] that a circuit consisting of a battery with electromotive force \mathcal{E} and electrical resistance R supports and electric current I related by $\mathcal{E} = IR$. For example, in a circuit consisting of a single loop with several batteries and several resistors, the circuit (loop) equation is $\sum \mathcal{E} = I \sum R$.

Kirchhoff never applied his laws to time-dependent circuits, such as in Lewin's example.^{27,28}

²⁷In 1857, Kirchhoff published two papers [66, 67] on the motion of electricity in wires, based on Weber's (action-at-a-distance) electrodynamics [68]. The consideration of a single wire by Kirchhoff followed the practice of telegraphy at the time [69]-[73], in which only a single wire appeared to be involved, and the role of the "ground"/"earth" as a return path to "complete the circuit" was not yet recognized, as were neither the capacitance between the wire and "ground" nor the self inductance of the wire + "ground" circuit. The kind of derivation of the "telegrapher's equation" for a two-wire telegraph "line" found in textbooks today, using Kirchhoff's circuit laws, was first given by Heaviside in 1876 [77]. See also the Appendix of [74].

Weber followed Neumann (1845) [75] who had introduced the concept of mutual inductance M of two circuits (but not the self inductance L of a single circuit). For example, the magnetic flux Φ_{12} through circuit 1 due to current I_2 in circuit 2 is related by $\Phi_{12} = M_{12}I_2 = \int \mathbf{B}_2 \cdot d\mathbf{Area}_1 = \oint \mathbf{A}_2 \cdot d\mathbf{l}_1$. We would add that the integral form of Faraday's law then tells us that if current I_2 varies with time, a (scalar) \mathcal{EMF} is induced in circuit 1 related by $\mathcal{E}_{12} = -\dot{\Phi}_{12} = -M_{12}\dot{I}_2$. Since Neumann, Weber and Kirchhoff had no concept of magnetic flux they did not say this, but rather emphasized the (vector) electromotive force (*electromotorische Kraft*) of one current element on another, and that the (scalar) \mathcal{EMF} on current element 1 due to changes in current element 2 as $\mathcal{E}_{12} = -k_{12}\dot{I}_2$, where k_{12} is a geometric factor. See the top of p. 199 of [66], where the part of W due to $i' = I_2$ is proportional to $M_{12}I_2$.

Rather impressively, Kirchhoff [66] deduced a wave equation for the current and charge on current elements (conductors), finding the wavespeed to be $c = 1/\sqrt{\epsilon_0\mu_0}$, where the constants ϵ_0 and μ_0 can be determined from electro- and magnetostatic experiments (Weber and Kohlrausch (1856) [76]), and the value of c was close to the speed of light as then known. However, as Weber's electrodynamics was based on action-at-a distance, and was not a field theory in the sense of Faraday, Weber and Kirchhoff did not infer that, since electric waves on wire moved at light speed, light must be an electromagnetic phenomenon.

We now consider that electromagnetic waves associated with conductors are almost entirely outside the conductors, and that the wavespeed of surface charge and current densities matches the wave speed in the medium outside the conductor, *i.e.*, c in case of vacuum. Kirchhoff's argument was the first demonstration of the latter result, which holds for waves propagating parallel to the surface of a conductor of "any" shape. In this sense, Kirchhoff did not deduce the "telegrapher's equation" (due to Heaviside (1876) [77]) for transmission lines based on two, parallel conductors, for which the wave speed is $v = 1/\sqrt{LC}$, where L and C are the inductance and capacitance per unit length. This behavior is consistent with Kirchhoff's result because of a general (geometrical) "theorem" that $LC = \epsilon_0\mu_0 = 1/c^2$ for a one-dimensional transmission line, if dielectric effects can be ignored and the current flows only on the surface of the conductors. See, for example, [78, 79, 80].

In [66], Kirchhoff discussed waves on a straight wire, and a circular wire loop of circumference $= n\lambda$ (which now finds application as a self-resonant loop antenna, particularly for $n = 1$; see, for example, sec. 2.2.2 of [81]). An ingredient in his analysis was that the electromagnetic potentials V and \mathbf{A} were subject to the condition $\nabla \cdot \mathbf{A} = (1/c)\partial V/\partial t$ (in Gaussian units), now known as the Kirchhoff gauge [82], the first-ever use of a gauge condition. *In Maxwell's theory and in the Kirchhoff gauge, the potential V can be said to propagate with imaginary velocity, *ic* [82].*

Kirchhoff also gave an analysis [67] for straight wires similar to that of Thomson [83], that the potential (and electric charge density) on a wire of length l with resistance R and capacitance C obeys the diffusion equation $d^2V/dx^2 = (RC/l^2)dV/dx$ (which does not involve the constant c), when effects of self inductance are ignored.

²⁸In 1864, Kirchhoff analyzed a series L - R - C circuit [84] without reference to his circuit laws, but including

A.1 Helmholtz

An early, important development of DC circuit theory was made by Helmholtz in 1853 [85], when he discussed what is now called Thévenin’s theorem [86], that any complicated but “linear” circuit is equivalent to a single source of electromotive force and a single resistance (or impedance in case of time-dependent circuits,²⁹ which were not considered by either Helmholtz or Thévenin).³⁰

Joule (1841) [89] had established that a current I through a resistor R generates heat at the rate I^2R whether or not I is constant, as an example of conservation of energy.³¹

Joule (1841) [89] had established that a current I through a resistor R generates heat at the rate I^2R whether or not I is constant, as an example of conservation of energy.³²

Perhaps the first quantitative study of time-dependent electrical circuits was reported by Weber in 1846, sec. 14 of [68], who measured the characteristic time of the discharge of a capacitor (Leyden jar) through a resistor, without offering any theoretical analysis.

In 1847, Helmholtz, p. 43 of [91], p. 142 of [92], considered the heat generated by the discharge of a capacitor C and argued that the initial (potential) energy of the capacitor was $Q^2/2C$, where Q is the charge on one of its electrodes. He also considered the effect of a moving magnet on an electrical circuit, p. 64 of [91], p. 158 of [92], using conservation of energy to deduce a circuit equation, although this is for a phenomenon beyond the scope of Kirchhoff’s laws (which apply to circuits “at rest”). Helmholtz did not consider the case of a circuit with self induction at this time.

In 1850, Helmholtz studied the propagation of electrical signals in nerves, modeling this as a resistor and a coil/inductor. When a sharp rise in electric potential was applied to this circuit, the current took a characteristic time to approach its asymptotic value. Helmholtz reported experimental results in [93, 94], and gave perhaps the first-ever time-dependent circuit analysis in [95]. He did not derive a circuit equation, but simply stated a hypothesis (*Voraussetzung*), p. 510 of [95], to be confirmed (or not) by experiment, that Ohm’s law would be modified by the presence of the coil to read, Helmholtz’ eqs. (2)-(3),

$$IR = \mathcal{E} - L\frac{dI}{dt}, \quad I = \frac{\mathcal{E}}{R} (1 - e^{-Rt/L}), \quad (36)$$

where I is the current, which is zero at time $t = 0$ when electromotive force \mathcal{E} is applied to the circuit that has resistance R and self-inductance L .³³ The data agreed well with this model, which can be said to provide the first extension of Ohm’s law/Kirchhoff’s loop equation to a time-dependent circuit.

the \mathcal{EMF} ’s associated with the inductor and capacitor in the manner of present circuit analysis. He cited Thomson’s analysis (1853) [99] of this circuit, but did not use Thomson’s energy argument (Appendix A.2).

²⁹The term **impedance** was introduced by Heaviside in 1886 [87].

³⁰For historical comments on Helmholtz, Thévenin and others, see [88].

³¹This followed the much earlier demonstration of the mechanical equivalent of heat by Rumford [90].

³²This followed the much earlier demonstration of the mechanical equivalent of heat by Rumford [90].

³³Helmholtz called the self inductance the *Potential P*, following Neumann (1845) [75], who invented the notion of self inductance, and apparently was consulted by Helmholtz during these studies. Helmholtz was one of the first to state that a changing current in a loop generates an \mathcal{EMF} given by $-L\dot{I}$, although this result was implicit in Neumann’s work [75] (which emphasized induction due to moving circuits more than that by changing currents in circuits at rest). Weber (1846) [68] discussed induction by changing currents in fixed circuits, but with an emphasis on current elements = moving charges.

A.2 Thomson

In 1848-1853, W. Thomson [96, 97, 98, 99, 100] addressed Weber’s experiments [68] on the discharge of a capacitor through a resistor, advocating consideration of conservation of energy.

Thomson argued (1853) [99], following remarks by Faraday [101], that if the circuit carries current I , it is also associated with a kind of “kinetic” energy equal to $LI^2/2$, where L is the self inductance of the circuit.³⁴ Then, as the capacitor discharges, its (potential) energy is transformed into “kinetic” energy plus heat, according to eq. (2) of [99],

$$-\frac{dQ^2}{dt 2C} = \frac{dLI^2}{dt 2} + I^2R, \quad I = \frac{dQ}{dt}, \quad 0 = LI + IR + \frac{Q}{C}. \quad (37)$$

Thomson noted that if the self inductance L is negligible, the circuit equation becomes,

$$I = \frac{dQ}{dt} = -\frac{Q}{RC}, \quad I = I_0 e^{-t/RC}, \quad (38)$$

while in general the current exhibits a damped oscillation, with frequency approximately $1/\sqrt{LC}$ for small R .

A.3 Maxwell

Thomson did not consider the case of an $R-L-C$ circuit with an impressed \mathcal{EMF} (such as a battery or electric generator), which may have first been done by Maxwell in 1868 [31]. Maxwell actually analyzed a coupled $R-L-C$ circuit, shown below,³⁵ which was driven by the generator on the left, while P labels the potential difference Q/C across the capacitor, and p is a resistor (not an inductor).

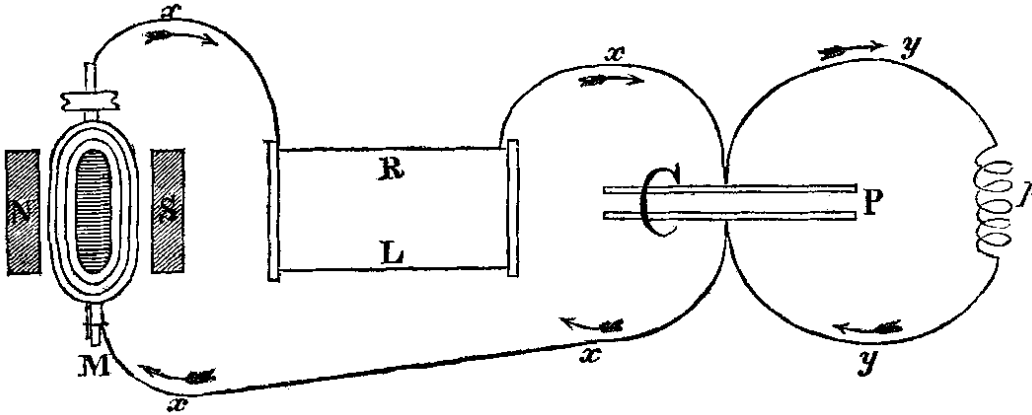

Maxwell simply stated without justification that the circuit equations are,

$$P = \frac{Q}{C} = I_y R_p, \quad C \frac{dP}{dt} = \frac{dQ}{dt} = I_x - I_y, \quad -\mathcal{E} + I_x R + L \frac{dI_x}{dt} + \frac{Q}{C} = 0, \quad (39)$$

³⁴Thomson called the self inductance L the “electrodynamic capacity”, denoting this by the symbol A .

³⁵This may be the first figure in which circuit elements were depicted (somewhat) abstractly, rather than realistically. *At this time, leading French artists were moving from realism to impressionism.*

where our $-\mathcal{E}$ is Maxwell's $Mn \cos nt$, the electromotive force of the electromechanical generator. The third of eq. (39) is Kirchhoff's loop equation as we know it today, for the left loop of the above circuit. Since Maxwell was a disciple of Thomson, we infer that Maxwell deduced the loop equation following Thomson's energy method.

Maxwell discussed Kirchhoff's relations for circuits with only batteries and resistors in Art. 282 of his *Treatise* (1873) [32]. He considered an R - C circuit (with no battery) in Art. 355, noting that both of these circuit elements have the same electric potential difference V across them,

$$V = \frac{Q}{C} = IR, \quad I = -\frac{dQ}{dt}, \quad \frac{dQ}{dt} = -\frac{1}{RC}, \quad Q = Q_0 e^{-t/RC} \quad (\text{Maxwell}). \quad (40)$$

where Q is the charge on one of the electrodes of the capacitor and I is the current through the resistor. Maxwell's analysis of Art. 355 was not quite the same as would follow from a generalization of Kirchhoff's loop equation to include a capacitor, as that would read,

$$0 = IR + \frac{Q}{C}, \quad I = \frac{dQ}{dt}, \quad \frac{dQ}{dt} = -\frac{Q}{RC}, \quad Q = Q_0 e^{-t/RC} \quad (\text{Kirchhoff}). \quad (41)$$

While the final result is the same, the logic of the two analyses is somewhat different.

Maxwell considered R - L circuits via a Lagrangian (energy) method in Arts. 578-583 of [33] (which suggests that he had also used this method in [31]). This has the advantage of clarifying how the changes in energy associated with the mutual inductances between multiple circuits appear in the various loop equations. Maxwell did not include capacitance in his Lagrangian analysis, but simply added the capacitive \mathcal{EMF} , Q/C , to the circuit equations in specific examples, including R - L - C circuits in Arts. 778-779, and an R - C circuit in Art. 780 (where the analysis was as in our eq. (41)).

Thus, Kirchhoff's laws for R - L - C circuits as still used today appeared in Maxwell's *Treatise*, although not identified there with Kirchhoff.

A.4 Applicability of Kirchhoff's Loop Equations

The energy methods of Helmholtz, Thomson and Maxwell clarify that the terms in Kirchhoff's loop equations are \mathcal{EMF} 's, and not necessarily "voltages".

It is common practice to associate the terms of the loop equations with "circuit elements", such as batteries, generators, resistors, capacitors and inductors. While use of Kirchhoff's laws permits computation of the currents, identifying where the associated \mathcal{EMF} 's are located is not always crisp, and interpreting measurements of currents by "voltmeters" can lead to misinterpretations of the results if one supposes that "voltmeters" measure "voltages".

This issue is particularly acute if some loops have magnetic flux that is not contained in a small coil of the "wire" of that loop. In Lewin's example, the magnetic flux in the primary solenoid may well be within a small coil, but the secondary consists of only a single "turn", so the associated inductive \mathcal{EMF} is not well localized, but rather is distributed around the entire secondary loop. Then, since inductive \mathcal{EMF} 's are associated with a vector potential, rather than a scalar potential, it can be misleading to interpret the inductive \mathcal{EMF} as related to a "voltage".

As Kirchhoff's loop equation including capacitors and inductors is deduced from considerations of energy conservation, it has rather general application.

However, if the circuit involves energy in other forms than Joule heating, and the "potential" and "kinetic" energies stored in the capacitors and inductors, one must proceed with care. An important case of this type is a circuit (antenna) that emits radiation which travels away from the circuit (called the "waste" by Heaviside [102]).

A tacit assumption of Kirchhoff's equation is that the current is the same in all elements of the circuit if it consists of only a single loop. This is not the case at very high frequencies, where the wavelength is smaller than the size of the circuit.

Even in these cases one can make a Thévenin-equivalent analysis with respect to two terminals, so long as their spacing is small compared to a wavelength. Then, the circuit can still be described as having an effective impedance, which permits use of Kirchhoff's laws. Of course, computation of the effective impedance requires techniques beyond those of Kirchhoff.

Lewin's circuit is within the range of applicability of Kirchhoff's loop equations, which can be used to predict measurements by the "voltmeters" in the experiment. However, this case highlights the fact that "voltmeters" actually measure the current inside them, and interpreting their measurements as being proportional to the "voltage drop" along a segment of the test circuit is not valid, in general.

References

- [1] W. Lewin, *Self Inductance — Kirchhoff's 2nd Law — Faraday's Law* (April 1, 2002), http://kirkmc.d.princeton.edu/examples/EM/lewin_ph8.02_040102.pdf
- [2] K.T. McDonald, *A Capacitor Paradox* (July 10, 2002), <http://kirkmc.d.princeton.edu/examples/twocaps.pdf>
- [3] D. Roller, *Misuse of the Names of Physical Units*, Am. J. Phys. **14**, 340 (1946), http://kirkmc.d.princeton.edu/examples/EM/roller_ajp_14_340_46.pdf
- [4] K.T. McDonald, *What Does an AC Voltmeter Measure?* (March 16, 2008), <http://kirkmc.d.princeton.edu/examples/voltage.pdf>
- [5] K.T. McDonald, *Voltage Drop, Potential Difference and \mathcal{EMF}* (Sept. 18, 2012), <http://kirkmc.d.princeton.edu/examples/volt.pdf>
- [6] C.J. Papachristou and A.N. Magoulas, *Electromotive Force: A Guide for the Perplexed* (June 6, 2013), <https://arxiv.org/abs/1211.6463>
- [7] O. Lodge, *On an Electrostatic Field Produced by Varying Magnetic Induction*, Phil. Mag. **27**, 469 (1889), http://kirkmc.d.princeton.edu/examples/EM/lodge_pm_27_116_89.pdf
- [8] J. Slepian, *Energy Flow In Electric Systems — the V_i Energy-Flow Postulate*, Trans. Am. IEE **61**, 835 (1942), http://kirkmc.d.princeton.edu/examples/EM/slepian_taiee_61_835_42.pdf

- [9] P. Hammond, *P.D. vs. E.M.F.*, Students Quart. J. **30**, 3 (1959),
http://kirkmcd.princeton.edu/examples/EM/hammond_sqj_30_3_59.pdf
- [10] J.W. Buchta, *Electromotive Force and Faraday's Law of Electromagnetic Induction*, Phys. Teacher **1**, 133 (1963), http://kirkmcd.princeton.edu/examples/EM/buchta_pt_1_133_63.pdf
- [11] M. Philips, *Electromotive Force and the Law of Induction*, Phys. Teacher **1**, 155 (1963),
http://kirkmcd.princeton.edu/examples/EM/philips_pt_1_155_63.pdf
- [12] D.R. Moorcroft, *Faraday's Law – Demonstration of a Teaser*, Am. J. Phys. **37**, 221 (1969), http://kirkmcd.princeton.edu/examples/EM/moorcroft_ajp_37_221_69.pdf
- [13] D.R. Moorcroft, *Faraday's Law, Potential and Voltage – Demonstration of a Teaser*, Am. J. Phys. **38**, 376 (1970), http://kirkmcd.princeton.edu/examples/EM/moorcroft_ajp_38_376_70.pdf
- [14] A. Shadowitz, *The Electromagnetic Field* (McGraw-Hill, 1975; Dover, 1988), sec. 11-1-6,
http://kirkmcd.princeton.edu/examples/EM/shadowitz_75_chap11.pdf
- [15] W. Klein, *Discovering Induction*, Am. J. Phys. **49**, 603 (1981),
http://kirkmcd.princeton.edu/examples/EM/klein_ajp_49_603_81.pdf
- [16] F. Reif, *Generalized Ohm's law, potential difference, and voltage measurements*, Am. J. Phys. **50**, 1048 (1982), http://kirkmcd.princeton.edu/examples/EM/reif_ajp_50_1048_82.pdf
- [17] R.H. Romer, *What do voltmeters measure?: Faraday's law in a multiply connected region*, Am. J. Phys. **50**, 1089 (1982),
http://kirkmcd.princeton.edu/examples/EM/romer_ajp_50_1089_82.pdf
- [18] P.C. Peters, *The role of induced emf's in simple circuits*, Am. J. Phys. **52**, 208 (1983),
http://kirkmcd.princeton.edu/examples/EM/peters_ajp_52_208_83.pdf
- [19] A. Hernández, *EMF and potential difference: an illustrative example*, Eur. J. Phys. **5**, 13 (1984), http://kirkmcd.princeton.edu/examples/EM/hernandez_ejp_5_13_84.pdf
- [20] W. Gough and J.P.G. Richards, **Electromagnetic or electromagnetic induction?**, Eur. J. Phys. **7**, 195 (1986), http://kirkmcd.princeton.edu/examples/EM/gough_ejp_7_195_86.pdf
- [21] J. Roche, *Explaining electromagnetic induction: a critical re-examination*, Phys. Ed. **22**, 91 (1987), http://kirkmcd.princeton.edu/examples/EM/roche_pe_22_91_87.pdf
- [22] S.Y. Mak and K. Young, *Voltage measurements in a loop surrounding a solenoid: Some further "paradoxes" due to stray capacitance*, Am. J. Phys. **56**, 254 (1988),
http://kirkmcd.princeton.edu/examples/EM/mak_ajp_56_254_88.pdf
- [23] D. Goldberg and O. Zik, *Topologically dependent voltage measurement*, Phys. Ed. **26**, 256 (1991), http://kirkmcd.princeton.edu/examples/EM/goldberg_pe_26_256_91.pdf
- [24] E. Lanzara and R. Zangara, *Potential difference measurements in the presence of a varying magnetic field*, Phys. Ed. **30**, 85 (1995),
http://kirkmcd.princeton.edu/examples/EM/lanzara_pe_30_85_95.pdf

- [25] D. Iencinella and G. Matteucci, *An introduction to the vector potential*, Eur. J. Phys. **25**, 249 (2004), http://kirkmcd.princeton.edu/examples/EM/iencinella_ejp_25_249_04.pdf
- [26] H.W. Nicholson, *What does the voltmeter read?* Am. J. Phys. **73**, 1194 (2005), http://kirkmcd.princeton.edu/examples/EM/nicholson_ajp_73_1194_05.pdf
- [27] B.H. McGuyer, *Symmetry and Voltmeters*, Am. J. Phys. **80**, 101 (2012), http://kirkmcd.princeton.edu/examples/EM/mcguyer_ajp_80_101_12.pdf
- [28] Maxim Integrated Products, *Position Sensor Exploits Faraday's Law*, App. Note 2238 (July 21, 2003), http://kirkmcd.princeton.edu/examples/EM/maxim_2238_03.pdf
- [29] G. Kirchhoff, *Ueber den Durchgang eines elektrischen Stromes durch eine Ebene, insbesondere durch eine kreisförmige*, Ann. d. Phys. Chem. **64**, 497 (1845), http://kirkmcd.princeton.edu/examples/EM/kirchhoff_apc_64_497_45.pdf
- [30] G. Kirchhoff, *Ueber die Auflösung der Gleichungen, auf welche man bei der Untersuchung der linearen Vertheilung galvanischer Ströme geführt wird*, Ann. d. Phys. Chem. **72**, 497 (1847), http://kirkmcd.princeton.edu/examples/EM/kirchhoff_apc_72_497_47.pdf
On the Solution of the Equations Obtained from the Investigation of the Linear Distribution of Galvanic Currents, IRE Trans. Circuit Theory **5-3**, 4 (1958), http://kirkmcd.princeton.edu/examples/EM/kirchhoff_apc_72_497_47_english.pdf
- [31] J.C. Maxwell, *On Mr. Grove's "Experiment in Magneto-electric Induction"*, Phil. Mag. **35**, 360 (1868), http://kirkmcd.princeton.edu/examples/EM/maxwell_pm_35_360_68.pdf
- [32] J.C. Maxwell, *A Treatise on Electricity and Magnetism*, Vol. 1 (Clarendon Press, Oxford, 1873), http://kirkmcd.princeton.edu/examples/EM/maxwell_treatise_v1_73.pdf
 Vol. 1, 3rd ed. (Clarendon Press, 1904), http://kirkmcd.princeton.edu/examples/EM/maxwell_treatise_v1_04.pdf
- [33] J.C. Maxwell, *A Treatise on Electricity and Magnetism*, Vol. 2 (Clarendon Press, Oxford, 1873), http://kirkmcd.princeton.edu/examples/EM/maxwell_treatise_v2_73.pdf
 Vol. 2, 3rded. (Clarendon Press, 1892), http://kirkmcd.princeton.edu/examples/EM/maxwell_treatise_v2_92.pdf
- [34] W. Lewin, *Non-Conservative Fields – Do Not Trust Your Intuition*, MIT Physics 4.02 (Mar. 15, 2002), http://kirkmcd.princeton.edu/examples/EM/lewin_lecsup_031502.pdf
- [35] J. Belcher and W. Lewin, *Self Inductance — Kirchhoff's 2nd Law — Faraday's Law*, MIT Physics 4.02 (Apr. 1, 2002), http://kirkmcd.princeton.edu/examples/EM/lewin_ph8.02_040102.pdf
- [36] O. Heaviside, *Electrical Papers*, Vol. 1 (Macmillan, 1894), http://kirkmcd.princeton.edu/examples/EM/heaviside_electrical_papers_1.pdf
- [37] J.W. Gibbs, *Velocity of Propagation of Electrostatic Forces*, Nature **53**, 509 (1896), http://kirkmcd.princeton.edu/examples/EM/gibbs_nature_53_509_96.pdf

- [38] D.H. Kobe, *Can electrostatics be described solely by a vector potential?* Am. J. Phys. **49**, 1075 (1981), http://kirkmcd.princeton.edu/examples/EM/kobe_ajp_49_1075_81.pdf
- [39] K.T. McDonald, *Potentials of a Hertzian Dipole in the Gibbs Gauge* (Aug. 23, 2012), <http://kirkmcd.princeton.edu/examples/gibbs.pdf>
- [40] A. Marcus, *The Electric Fields Associated with a Steady Current in a Long Cylindrical Conductor*, Am. J. Phys. **9**, 225 (1941), http://kirkmcd.princeton.edu/examples/EM/marcus_ajp_9_225_41.pdf
- [41] A. Sommerfeld, *Electrodynamics* (Academic Press, 1980), sec. 17, http://kirkmcd.princeton.edu/examples/EM/sommerfeld_em_52_sec17.pdf
- [42] O. Jefimenko, *Demonstration of the Electric Fields of Current-Carrying Conductors*, Am. J. Phys. **30**, 19 (1962), http://kirkmcd.princeton.edu/examples/EM/jefimenko_ajp_30_19_62.pdf
- [43] W.G.V. Rosser, *What Makes an Electric Current Flow?* Am. J. Phys. **31**, 884 (1963), http://kirkmcd.princeton.edu/examples/EM/rosser_ajp_31_884_63.pdf
- [44] B.R. Russell, *Surface Charges on Conductors Carrying Steady Currents*, Am. J. Phys. **36**, 527 (1968), http://kirkmcd.princeton.edu/examples/EM/russell_ajp_36_527_68.pdf
- [45] W.G.V. Rosser, *Magnitudes of Surface Charge Distributions Associated with Electric Current Flow*, Am. J. Phys. **38**, 265 (1970), http://kirkmcd.princeton.edu/examples/EM/rosser_ajp_38_265_70.pdf
- [46] S. Parker, *Electrostatics and Current Flow*, Am. J. Phys. **38**, 720 (1970), http://kirkmcd.princeton.edu/examples/EM/parker_ajp_38_720_70.pdf
- [47] E. Merzbacher, *A Puzzle*, Am. J. Phys. **48**, 178 (1980), http://kirkmcd.princeton.edu/examples/EM/merzbacher_ajp_48_178_80.pdf
- [48] M. Heald, *Electric fields and charges in elementary circuits*, Am. J. Phys. **52**, 522 (1984), http://kirkmcd.princeton.edu/examples/EM/heald_ajp_52_522_84.pdf
- [49] R.N. Varney and L.H. Fisher, *Electric fields associated with stationary currents*, Am. J. Phys. **52**, 1097 (1984), http://kirkmcd.princeton.edu/examples/EM/varney_ajp_52_1097_84.pdf
- [50] W.R. Moreau *et al.*, *Charge density in circuits*, Am. J. Phys. **53**, 552 (1985), http://kirkmcd.princeton.edu/examples/EM/moreau_ajp_53_552_85.pdf
- [51] J.M. Aguirregabiria, A. Hernández and M. Rivas, *An example of surface charge distribution on conductors carrying steady currents*, Am. J. Phys. **60**, 138 (1992), http://kirkmcd.princeton.edu/examples/EM/aguirregabiria_ajp_60_138_92.pdf
- [52] J.D. Jackson, *Surface charges on circuit wires and resistors play three roles*, Am. J. Phys. **64**, 855 (1996), http://kirkmcd.princeton.edu/examples/EM/jackson_ajp_64_855_96.pdf

- [53] J.M. Aguirregabiria, A. Hernández and M. Rivas, *Surface charges and energy flow in a ring rotating in a magnetic field*, Am. J. Phys. **64**, 892 (1996),
http://kirkmcd.princeton.edu/examples/EM/aguirregabiria_ajp_64_892_96.pdf
- [54] Y. Aharonov and D. Bohm, *Significance of the Electromagnetic Potentials in the Quantum Theory*, Phys. Rev. **115**, 485 (1959),
http://kirkmcd.princeton.edu/examples/QM/aharonov_pr_115_485_59.pdf
- [55] W. Ehrenberg and R.E. Siday, *Significance of the Electromagnetic Potentials in the Quantum Theory*, Proc. Phys. Soc. B **62**, 8 (1949),
http://kirkmcd.princeton.edu/examples/QM/ehrenberg_pps_b62_8_49.pdf
- [56] E.J. Konopinski, *What the electromagnetic vector potentials describes*, Am. J. Phys. **46**, 499 (1978), http://kirkmcd.princeton.edu/examples/EM/konopinski_ajp_46_499_78.pdf
- [57] B. Batell and A. Ferstl, *Electrically induced magnetic fields; a consistent approach*, Am. J. Phys. **71**, 925 (2003), http://kirkmcd.princeton.edu/examples/EM/batell_ajp_71_925_03.pdf
- [58] G. Rousseaux, R. Kofman, and O. Minazzoli, *The Maxwell-Lodge effect: significance of electromagnetic potentials in the classical theory*, Eur. Phys. J. D **49**, 249 (2008),
http://kirkmcd.princeton.edu/examples/EM/rousseau_epjd_49_249_08.pdf
- [59] K.T. McDonald, *The Fields Outside a Long Solenoid with a Time-Dependent Current* (Dec. 6, 1996), <http://kirkmcd.princeton.edu/examples/solenoid.pdf>
- [60] K.T. McDonald, *Electromagnetic Fields of a Small Helical Toroidal Antenna* (Dec. 8, 2008), <http://kirkmcd.princeton.edu/examples/cwhta.pdf>
- [61] T.H. Boyer, *Misinterpretation of the Aharonov-Bohm Effect*, Am. J. Phys. **40**, 56 (1972),
http://kirkmcd.princeton.edu/examples/QM/boyer_ajp_40_56_72.pdf
- [62] K.T. McDonald, *Orbital and Spin Angular Momentum of Electromagnetic Fields* (Mar. 12, 2009), <http://kirkmcd.princeton.edu/examples/spin.pdf>
- [63] K.T. McDonald, *Vector Potential of a Long Solenoid in the Poincaré Gauge* (Jan. 17, 2017), <http://kirkmcd.princeton.edu/examples/poincare.pdf>
- [64] C.H. Page, *Electromotive force, potential difference, and voltage*, Am. J. Phys. **45**, 978 (1977), http://kirkmcd.princeton.edu/examples/EM/page_ajp_45_978_77.pdf
- [65] G. Ohm, *Die galvanische Kette* (Berlin, 1827),
http://kirkmcd.princeton.edu/examples/EM/ohm_galvanische_kette.pdf
The Galvanic Circuit Mathematically Investigated (Van Nostrand, 1891),
http://kirkmcd.princeton.edu/examples/EM/ohm_galvanic_circuit.pdf
- [66] G. Kirchhoff, *Ueber die Bewegung der Elektrizität in Drähten*, Ann. d. Phys. Chem. **100**, 193 (1857), http://kirkmcd.princeton.edu/examples/EM/kirchhoff_apc_100_193_57.pdf
On the Motion of Electricity in Wires, Phil. Mag. **13**, 393 (1857),
http://kirkmcd.princeton.edu/examples/EM/kirchhoff_pm_13_393_57.pdf

- [67] G. Kirchhoff, *Ueber die Bewegung der Elektrizität in Leitern*, Ann. d. Phys. Chem. **102**, 529 (1857), http://kirkmcd.princeton.edu/examples/EM/kirchhoff_apc_102_529_57.pdf
P. Graneau and A.K.T. Assis, *Kirchhoff on the Motion of Electricity in Conductors*, Apeiron **19**, 19 (1994), http://kirkmcd.princeton.edu/examples/EM/kirchhoff_apc_102_529_57_english.pdf
- [68] W. Weber, *Elektrodynamische Maassbestimmungen*, Abh. König. Sächs. Gesell. Wiss. 209 (1846), http://kirkmcd.princeton.edu/examples/EM/weber_aksgw_209_46.pdf
http://kirkmcd.princeton.edu/examples/EM/weber_aksgw_209_46_english.pdf
- [69] E. Highton, *The Electric Telegraph: Its History and Progress* (Weal, London, 1852), http://kirkmcd.princeton.edu/examples/EM/highton_telegraph_52.pdf
- [70] L. Turnbull, *The Electro-Magnetic Telegraph: with a Historical Account of Its Rise, Progress and Present Condition* (Hart, Philadelphia, 1853), http://kirkmcd.princeton.edu/examples/EM/turnbull_telegraph_53.pdf
- [71] G.B. Prescott, *History, Theory, and Practice of the Electric Telegraph* (Ticknor and Fields, Boston, 1866), http://kirkmcd.princeton.edu/examples/EM/prescott_telegraph_66.pdf
- [72] R. Sabine, *The History and Progress of the Electric Telegraph* (Lockwood, London, 1872), http://kirkmcd.princeton.edu/examples/EM/sabine_telegraph_72.pdf
- [73] J.J. Fahie, *A History of Electric Telegraphy to the Year 1837* (Spon, London, 1884), http://kirkmcd.princeton.edu/examples/EM/fahie_telegraphy_84.pdf
- [74] K.T. McDonald, *Distortionless Transmission Line* (Nov. 11, 1996), <http://kirkmcd.princeton.edu/examples/distortionless.pdf>
- [75] F.E. Neumann, *Allgemeine Gesetze der inducirten elektrischen Ströme*, Abh. König. Akad. Wiss. Berlin **1**, 45 (1845), http://kirkmcd.princeton.edu/examples/EM/neumann_akawb_1_45.pdf
- [76] W. Weber and R. Kohlrausch, *Ueber die Elektrizitätsmenge, welche bei galvanischen Strömen durch den Querschnitt der Kette fließt*, Ann. d. Phys. **99**, 10 (1856), http://kirkmcd.princeton.edu/examples/EM/weber_ap_99_10_56.pdf
http://kirkmcd.princeton.edu/examples/EM/weber_ap_99_10_56_english.pdf
- [77] O. Heaviside, *On the Extra Current*, Phil. Mag. **2**, 135 (1876), http://kirkmcd.princeton.edu/examples/EM/heaviside_pm_2_135_76.pdf
- [78] A. Föppl *Theorie der Elektrizität*, Vol. 1, sec. 73, p. 331 (Teubner, Leipzig, 1904), http://kirkmcd.princeton.edu/examples/EM/abraham_foppl_elektrizitat_v1_04.pdf
- [79] R. Becker, *Electromagnetic Fields and Interactions* (Blaisdell, 1964).
- [80] K.T. McDonald, *Waves in Conducting Media*, <http://kirkmcd.princeton.edu/examples/ph501/ph501lecture13.pdf>
- [81] K.T. McDonald, *Reactance of Small Antennas* (June 3, 2009), http://kirkmcd.princeton.edu/examples/cap_antenna.pdf

- [82] J.A. Heras, *The Kirchhoff gauge*, Ann. Phys. **321**, 1265 (2006),
http://kirkmcd.princeton.edu/examples/EM/heras_ap_321_1265_06.pdf
- [83] W. Thomson, *On the Theory of the Electric Telegraph*, Proc. Roy. Soc. London **7**, 382 (1855), http://kirkmcd.princeton.edu/examples/EM/thomson_prs1_7_382_55.pdf
- [84] G. Kirchhoff, *Zur Theorie der Entladung einer Leydener Flasche*, Ann. d. Phys. **1**, 551 (1864), http://kirkmcd.princeton.edu/examples/EM/kirchhoff_ap_1_551_64.pdf
- [85] H. Helmholtz, *Ueber einige Gesetze der Vertheilung elektrischer Ströme in körperlichen Leitern mit Anwendung auf die thierisch-elektrischen Versuche*, Ann. d. Phys. Chem. **89**, 211 (1853), http://kirkmcd.princeton.edu/examples/EM/helmholtz_ap_89_211_53.pdf
Some Laws Concerning the Distribution of Electric Currents in Volume Conductors With Applications to Experiments on Animal Electricity,
http://kirkmcd.princeton.edu/examples/EM/helmholtz_ap_89_211_53_english.pdf
- [86] L. Thévenin, *Extension de la loi d'Ohm aux circuits électromoteurs complexes*, Ann. Tél. **10**, 222 (1883);
Sur un nouveau théorème délectricité dynamique, Compte Rendus Acad. Sci. **97**, 159 (1883), http://kirkmcd.princeton.edu/examples/EM/thevenin_cras_97_159_83.pdf
- [87] O. Heaviside, *Oscillatory impressed force at one end of a line*, Electrician **17**, 212 (1886),
http://kirkmcd.princeton.edu/examples/EM/heaviside_electrician_17_212_86.pdf
- [88] D.H. Johnson, *Origins of the Equivalent Circuit Concept: The Voltage-Source Equivalent*, Proc. IEEE **91**, 636 (2003),
http://kirkmcd.princeton.edu/examples/EM/johnson_pieee_91_636_03.pdf
- [89] J.P. Joule, *On the Heat evolved by Metallic Conductors of Electricity, and in the Cells of a Battery during Electrolysis*, Phil. Mag. **19**, 260 (1841),
http://kirkmcd.princeton.edu/examples/EM/joule_pm_19_260_41.pdf
- [90] Count Rumford, *An Inquiry concerning the Source of the Heat which is excited by Friction*, Phil. Trans. Roy. Soc. London **88**, 80 (1798),
http://kirkmcd.princeton.edu/examples/statmech/rumford_ptrsl_88_80_98.pdf
- [91] H. Helmholtz, *Über die Erhaltung der Kraft* (Reimer, Berlin, 1847),
http://kirkmcd.princeton.edu/examples/statmech/helmholtz_erhaltung_47.pdf
- [92] H. Helmholtz, *On the Conservation of Force*, p. 114 of *Scientific Memoirs*, Vol. 1 (Taylor and Francis, 1853), http://kirkmcd.princeton.edu/examples/EM/tyndall_francis_v1.pdf
- [93] H. Helmholtz, *Messungen über den zeitlichen Verlauf der Zuckung animalischer Muskeln und die Fortpflanzungsgeschwindigkeit der Heizung in den Nerven*, Archiv Anat. Physio. p. 267 (1850); p. 764 of *Wissenschaftliche Abhandlungen*, Vol. 2 (Barth, Leipzig, 1883),
http://kirkmcd.princeton.edu/examples/EM/helmholtz_abhandlungen_v2.pdf

- [94] H. Helmholtz, *Ueber die Methoden, kleinste Zeittheile zu messen, und ihre Anwendung für physiologische Zwecke* (1850); p. 862 of *Wissenschaftliche Abhandlungen*, Vol. 2 (Barth, Leipzig, 1883), http://kirkmcd.princeton.edu/examples/EM/helmholtz_abhandlungen_v2.pdf
- [95] H. Helmholtz, *Ueber die Dauer und den Verkauf der durch Stromesschwankungen inducirten elektrischen Ströme*, *Ann. d. Phys. Chem.* **88**, 505 (1851), http://kirkmcd.princeton.edu/examples/EM/helmholtz_ap_88_505_51.pdf
- [96] W. Thomson, *On the Theory of Electro-Magnetic Induction*, *Brit. Assoc. Adv. Sci.*, p. 9 (1848), http://kirkmcd.princeton.edu/examples/EM/thomson_baas_9_48.pdf
- [97] W. Thomson, *On the Mechanical Theory of Electrolysis*, *Phil. Mag.* **2**, 429 (1853), http://kirkmcd.princeton.edu/examples/EM/thomson_pm_2_429_51.pdf
- [98] W. Thomson, *On the Mechanical Values of Distributions of Electricity, Magnetism, and Galvanism*, *Proc. Glasgow Phil. Soc.* **3**, 281 (1853), http://kirkmcd.princeton.edu/examples/EM/thomson_pgps_3_281_53.pdf
- [99] W. Thomson, *On Transient Electric Currents*, *Phil. Mag.* **5**, 393 (1853), http://kirkmcd.princeton.edu/examples/EM/thomson_pm_5_393_53.pdf
- [100] W. Thomson, *Dynamical Relations of Magnetism*, in *Nichol's Cyclopædia of the Physical Sciences* (1860), p. 545, http://kirkmcd.princeton.edu/examples/EM/thomson_nichols_60.pdf
- [101] M. Faraday, *Experimental Researches in Electricity.—Ninth Series*, *Phil. Trans. Roy. Soc. London* **125**, 41 (1835), http://kirkmcd.princeton.edu/examples/EM/faraday_ptsr1_125_41_35.pdf
- [102] O. Heaviside, *The Waste of Energy from a Moving Electron*, *Nature* **67**, 6 (1902), http://kirkmcd.princeton.edu/examples/EM/heaviside_nature_67_6_02.pdf