

A Detector Scenario for the Muon-Collider Cooling Experiment

C. Lu, K.T. McDonald and E.J. Prebys

Princeton U.

October 21, 1997

Princeton/ $\mu\mu$ /97-8

<http://www.hep.princeton.edu/~mcdonald/mumu>

Goal: Measure the emittance of the muon beam to 3% accuracy before and after the muon cooling apparatus.

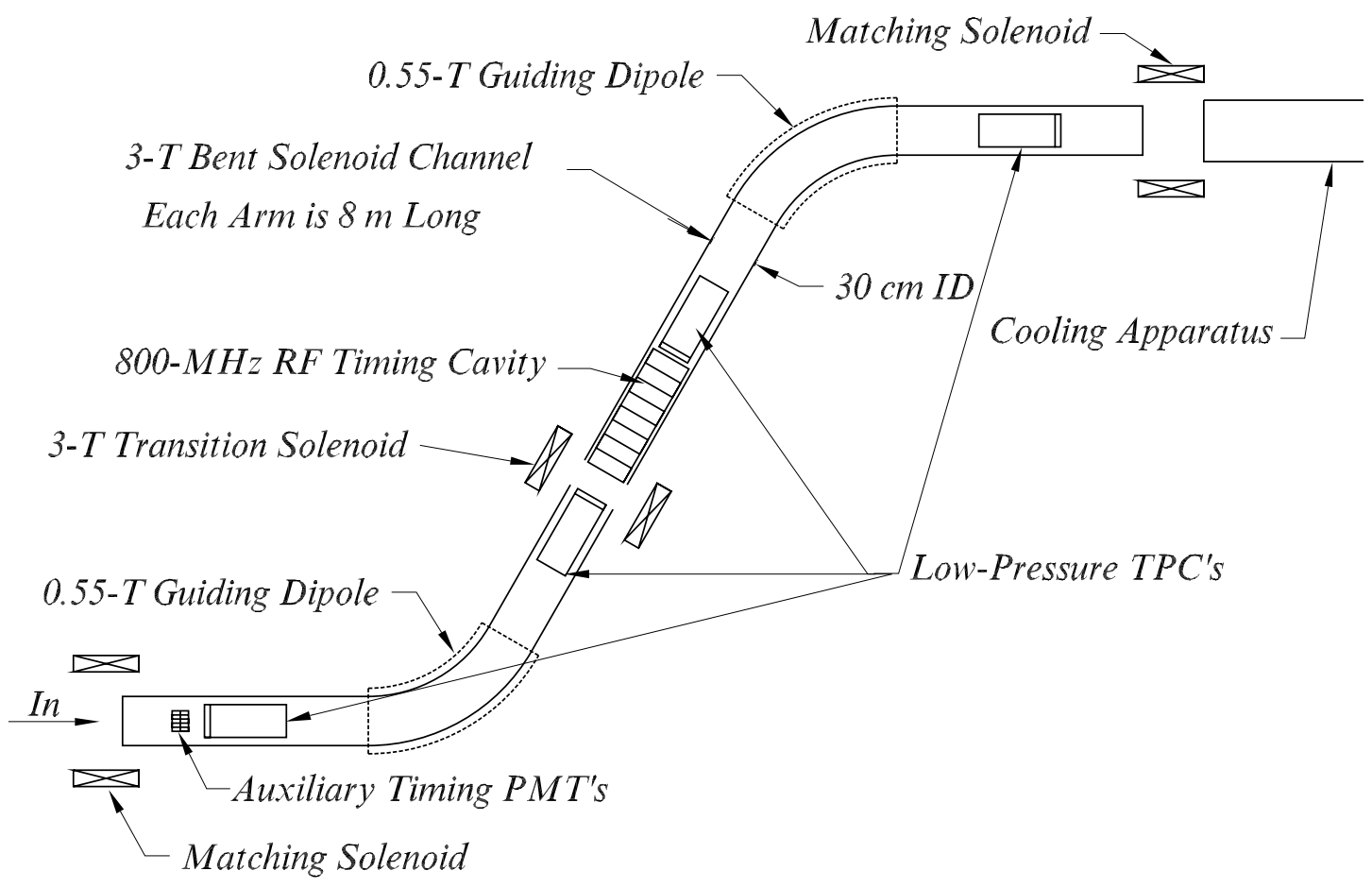
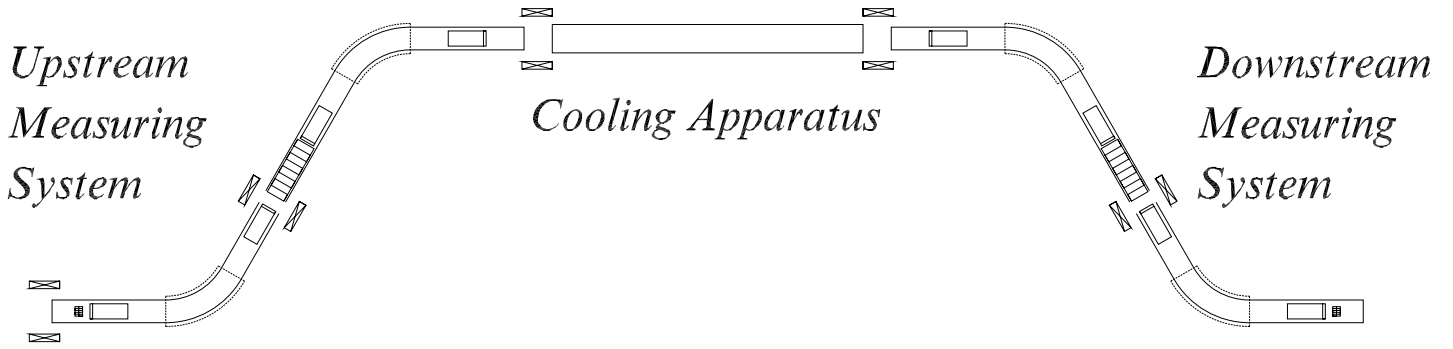

Overview

Measure muons individually, and form a virtual bunch in software:

⇒ Must know timing to ≈ 10 psec to select muons properly phased to the 800-MHz RF of the cooling apparatus.

⇒ Use RF accelerating cavity to correlate time with momentum.

⇒ Must measure momentum 4 times.

[⇒ Must also have coarse timing ($\lesssim 300$ psec) to remove phase ambiguity.]

Large transverse emittance, $\epsilon_{N,x} = 1500\pi$ mm-mrad:

⇒ Confine the muon beam in a 3-Tesla solenoid channel.

⇒ All muon detection in the 3-T field.

⇒ Use bent solenoids (toroidal sectors with guiding dipoles) for momentum dispersion.

Muon momentum = 165 MeV/c:

⇒ Larmor period of 1.15 m sets scale for detector arrangement.

⇒ Resolution limited by multiple scattering.

⇒ Perform tracking in a low-pressure gas.

3-T magnetic field ⇒ simplest if detector $\mathbf{E} \parallel \mathbf{B}$.

⇒ **Time Projection Chambers** (TPC's)

Higher momentum muons ⇒ higher B and/or larger radius magnets.

Time Projection Chamber

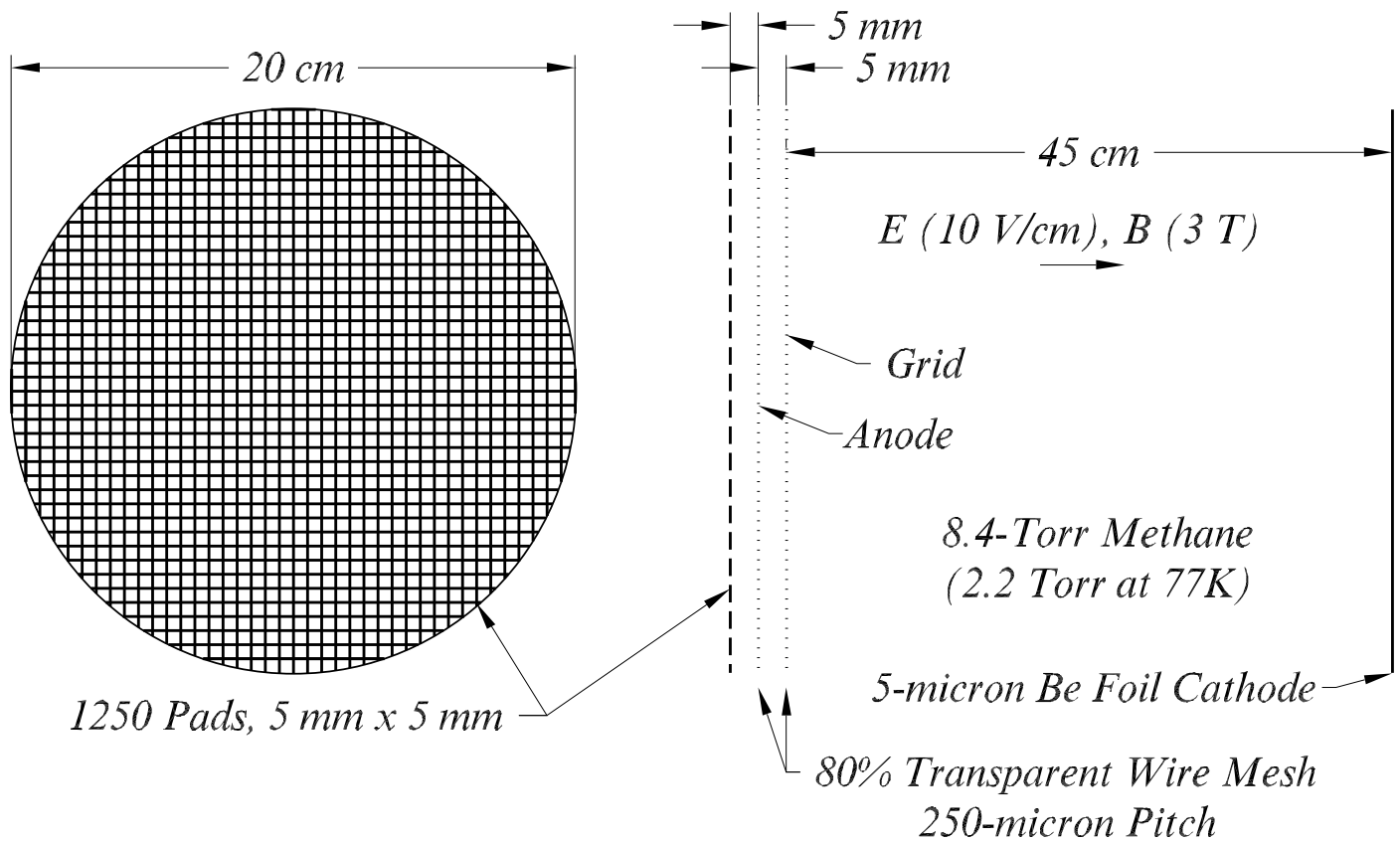

- Two TPC's in same pressure vessel for each of 4 momentum spectrometers.
- Low gas pressure \Rightarrow low operating voltage.
- 1250 cathode pads, 50-MHz timing sampling.
- Analog pipeline via 512-deep switched-capacitor arrays.
- No trigger: capture entire 10 μ sec window.
- Could process ≈ 10 tracks $\Rightarrow \approx 1$ MHz rate capability.

π - μ - e Identification

Use time of flight between auxiliary timing device and RF timing cavity.

Good π - μ - e separation requires resolution close to 50 psec.

\Rightarrow prefer microchannel-plate PMT over fine mesh PMT.

Cost Estimate

- Bent solenoid channel \$3M
- Two 800-MHz RF timing cavities \$1M
- 8 TPC's, 10,000 channels, \$50/channel \$0.5M
- Auxiliary timing detector based on MCP-PMT's \$0.3M
- **Total** **\$4.8M**

Detector Requirements

Must measure the distribution of the beam muons on all 6 axes of 6-D phase space: x, x', y, y', P and z or t .

$$\sigma_i = \text{rms width.}$$

Uncertainty in $\sigma_i \equiv \delta_{\sigma_i}$.

$$\epsilon = \prod_{i=1}^6 \sigma_i, \quad \text{so} \quad \frac{\delta_\epsilon}{\epsilon} = \sqrt{\sum_{i=1}^6 \left(\frac{\delta_{\sigma_i}}{\sigma_i}\right)^2} \approx \sqrt{6} \frac{\delta_\sigma}{\sigma}.$$

$$\text{Proposed goal:} \quad \frac{\delta_\sigma}{\sigma} = 0.01, \quad \text{so} \quad \frac{\delta_\epsilon}{\epsilon} = 0.03.$$

Effect of Detector Resolution

σ_D = detector resolution (in parameter i).

δ_{σ_D} = uncertainty in detector resolution.

σ_O = observed rms width, $\sigma_O^2 = \sigma_i^2 + \sigma_D^2$.

$$\Rightarrow \sigma_i^2 = \sigma_O^2 - \sigma_D^2.$$

$$\delta_{\sigma_i^2}^2 = \delta_{\sigma_O^2}^2 + \delta_{\sigma_D^2}^2.$$

$$\delta_{\sigma_O^2} = \sqrt{\frac{2}{N}} \sigma_O^2 = \sqrt{\frac{2}{N}} (\sigma_i^2 + \sigma_D^2).$$

$$\left(\frac{\delta_{\sigma_i}}{\sigma_i}\right)^2 = \frac{1}{2N} \left(1 + \frac{\sigma_D^2}{\sigma_i^2}\right)^2 + \left(\frac{\sigma_D}{\sigma_i}\right)^4 \left(\frac{\delta_{\sigma_D}}{\sigma_D}\right)^2.$$

Perfectly Known Resolution

$$\delta_{\sigma_D} = 0 \Rightarrow \frac{\delta_{\sigma_i}}{\sigma_i} = \sqrt{\frac{1}{2N}} \left(1 + \frac{\sigma_D^2}{\sigma_i^2} \right).$$

$$\text{If } \sigma_D > \sigma_i, \quad \text{then} \quad N \propto \left(\frac{\sigma_D}{\sigma_i} \right)^4.$$

$$\text{If } \sigma_D < \sigma_i, \quad \text{then} \quad \frac{\delta_{\sigma_i}}{\sigma_i} \approx \sqrt{\frac{1}{2N}}.$$

\Rightarrow Require $\sigma_D < \sigma_i$.

[Otherwise N varies as fourth power of desired accuracy, rather than as the square.]

\Rightarrow Need $N \approx 10,000$ to achieve $\delta_{\sigma_i}/\sigma_1 = 0.01$.

Large-N Limit

$$\frac{\delta_{\sigma_i}}{\sigma_i} = \left(\frac{\sigma_D}{\sigma_i} \right)^2 \frac{\delta_{\sigma_D}}{\sigma_D}.$$

Good results can only be obtained if σ_D/σ_i is less than one.

If this ratio is much less than one very good results are possible.

Maximum Acceptable Detector Resolution

Goal: $\frac{\delta_{\sigma_i}}{\sigma_i} < 0.007$ due to detector resolution.

Suppose $\frac{\delta_{\sigma_D}}{\sigma_D} < 0.2$.

Then $\sigma_D < \sqrt{\frac{\delta_{\sigma_i}/\sigma_i}{\delta_{\sigma_D}/\sigma_D}} \sigma_i = 0.19\sigma_i$.

If $\frac{\delta_{\sigma_D}}{\sigma_D} < 0.01$, then we can have $\sigma_D \approx \sigma_i$ and $\frac{\delta_{\sigma_i}}{\sigma_i} = 0.01$.

Determination of Detector Resolution

Must determine the detector resolutions, $\sigma_{i,D}$, and their uncertainties, $\delta_{\sigma_{i,D}}$ in preliminary studies.

For this, leave out cooling apparatus and join the ‘before’ and ‘after’ detector arms.

Phase-Space Parameters of the FOFO-Channel Cooling Experiment

| Parameter | Input Value | Output Value |
|--|----------------|-----------------|
| P (MeV/ c) | 165 | 165 |
| E (MeV) | 198 | 198 |
| γ | 1.85 | 1.85 |
| β | 0.84 | 0.84 |
| $\gamma\beta$ | 1.56 | 1.56 |
| $\epsilon_{x,N} = \epsilon_{y,N}$ (π mm-mrad) | 1250 | 625 |
| $\epsilon_x = \epsilon_y$ (π mm-mrad) | 800 | 400 |
| β^* (cm) | 10 | 14 |
| $\sigma_x = \sigma_y$ (mm) | 9 | 9 |
| $\sigma_{x'} = \sigma_{y'}$ (mrad) | 90 | 45 |
| σ_P/P | 0.03 | 0.04 |
| $\sigma_E/E = \beta^2\sigma_P/P$ | 0.021 | 0.028 |
| σ_t (cm) | 1 | 1.2 |
| $\sigma_t = \sigma_z/\beta c$ (ps) | 40 | 48 |

Parameters of Optimized Bent Solenoid Channels

| Parameter | Value | Value |
|-----------------------------|---------------|---------------|
| F_{RF} | 800 MHz | 400 MHz |
| P_{muon} | 165 MeV/ c | 165 MeV/ c |
| B_{Guide} | 0.55 T | 0.55 T |
| B_s | 3 T | 1.5 T |
| θ_{bend} | 1 rad | 1 rad |
| R_{bend} | 1 m | 1 m |
| λ_B | 1.15 m | 2.30 m |
| R_s | 15 cm | 24 cm |
| L_s | 4 m | 4 m |
| Cost per 4-m section | 0.71M\$ | 0.53M\$ |
| β^* | 36.7 cm | 73.3 cm |
| $\sigma_x = \sigma_y$ | 17 mm | 24 mm |
| $\sigma_{x'} = \sigma_{y'}$ | 47 mrad | 33 mrad |
| L_{tracking} | 43 cm | 57 cm |
| n | 33 clusters/m | 33 clusters/m |

Optimization procedure discussed below.

Required Detector Resolutions

to achieve measurement accuracy of 1% on the rms widths σ_i , assuming the detector resolution function is known to 20%, *i.e.*, $\delta_{\sigma_D}/\sigma_D = 0.2$.

| Parameter | Value |
|---------------------------------|-------------------|
| $\sigma_{x,D} = \sigma_{y,D}$ | 200 μm |
| $\sigma_{x',D} = \sigma_{y',D}$ | 5 mrad |
| $\sigma_{P,D}/P$ | 0.0014 |
| $\sigma_{z,D}$ | 2 mm |
| $\sigma_{t,D}$ | 8 ps |

The required detector resolution σ_D varies as the reciprocal of the square root of the uncertainty δ_{σ_D} in the resolution.

The strongest requirement on $\sigma_{P,D}/P$ comes from the need to extrapolate the timing measurement along the beam.

Extrapolating Along the Beam

Must extrapolate 6 rms widths, σ_i , to the entrance (exit) of the cooling apparatus.

⇒ Extrapolation of time measurement by at about 4 m.

$$t = \frac{L}{\beta_z c},$$

$$\delta t = \frac{L}{\beta_z^2 c} \delta \beta = \frac{L}{\gamma^2 \beta c} \frac{\delta P}{P} \approx 1000 \text{ [ps]} \left[\frac{L}{1 \text{ m}} \right] \frac{\delta P}{P}.$$

$$\text{Want } \delta t < 8 \text{ psec, } \Rightarrow \frac{\sigma_P}{P} = 0.0014.$$

Helical Trajectories

Muon trajectory is a **helix** in a uniform solenoid with field \mathbf{B}_s .

Axis of helix is called **guiding ray**.

Trajectory is a circle in plane \perp to guiding ray.

$$\text{Larmor frequency : } \quad \Omega_B = 0.852 \text{ GHz} \frac{B_s [\text{T}]}{\gamma}.$$

$$\text{Larmor wavelength: } \quad \lambda_B [\text{m}] = 2\pi \frac{P [\text{MeV}/c]}{300 B_s [\text{T}]}.$$

$$\text{Larmor radius: } R_{\text{curv}} [\text{m}] = \frac{P_{\perp}}{eB_s} = \frac{P}{eB_s} \sin \theta = \frac{P [\text{MeV}/c]}{300 B_s [\text{T}]} \sin \theta.$$

Example, 165-MeV/ c muons in a 3-T field \Rightarrow

$$\Omega_B = 1389 \text{ MHz},$$

$$\lambda_B = 1.15 \text{ m and}$$

$$R_{\text{curv}} = 18.3 \sin \theta \text{ cm.}$$

Curvature Drift in a Bent Solenoid

As a muon enters a bent solenoid it encounters a component of \mathbf{B} that is \perp to \mathbf{v} and in the plane of the bend.

$\Rightarrow \mathbf{v} \times \mathbf{B}$ force deflects the muon out of the bend plane.

Trick: analyze in frame that rotates with muon around the bend.

Laboratory angular velocity $\Omega = \frac{\beta_z c}{R_{\text{bend}}} \approx \frac{\beta c}{R_{\text{bend}}}.$

\Rightarrow Centrifugal force, $F_{\text{cent}} = \gamma m \Omega^2 R_{\text{bend}} \approx \frac{\gamma m c^2 \beta^2}{R_{\text{bend}}}.$

Equivalent electric field: $E_{\text{cent}} \approx \frac{\gamma m c^2 \beta^2}{e R_{\text{bend}}},$ outwards.

\Rightarrow Need $\mathbf{v}_{\text{drift}}$ so that $0 = e[\mathbf{E}_{\text{cent}} + \mathbf{v}_{\text{drift}} \times \mathbf{B}_s]$

$$\Rightarrow v_{\text{drift}} = \frac{E_{\text{cent}}}{B_s} \approx \frac{\gamma m c^2 \beta^2}{e R_{\text{bend}} B_s} = \frac{P}{e B_s} \frac{\beta c}{R_{\text{bend}}}.$$

Example: $B_s = 3$ T, $R_{\text{bend}} = 1$ m, $P = 165$ MeV/c,

$\Rightarrow \Delta y = 16$ cm.

Guiding Dipole

Curvature drift can be cancelled for central momentum if a vertical **guiding dipole** is superimpose on the horizontal bent solenoid.

Chose B_G to make momentum P_0 move in circle of radius R_{bend} :

$$B_G \text{ [T]} = \frac{P_0}{eR_{\text{bend}}} = \frac{P_0 \text{ [MeV}/c]}{300R_{\text{bend}} \text{ [m]}}.$$

If $P \neq P_0$, still have vertical drift, but at rate

$$\Delta v_{\text{drift}} = v_{\text{drift}}(P) - v_{\text{drift}}(P_0) \approx \frac{\Delta P}{eB_s} \frac{\beta c}{R_{\text{bend}}}.$$

\Rightarrow Vertical dispersion due to horizontal bend!

$$t_{\text{bend}} = \frac{R_{\text{bend}}\theta_{\text{bend}}}{\beta_z c} \approx \frac{R_{\text{bend}}\theta_{\text{bend}}}{\beta c},$$

$$\Rightarrow y_G = \Delta v_{\text{drift}} t_{\text{bend}} \approx \frac{P_0}{eB_s} \frac{\Delta P}{P_0} \theta_{\text{bend}}.$$

Guiding Dipole

A bent solenoid is really a sector of a **toroid**.

$$\Rightarrow B_s(x) = B_s(0) \frac{R_{\text{bend}}}{R_{\text{bend}} + x}.$$

[x is horizontal, along radius of bend; y is vertical.]

$$\Rightarrow \text{Guide field should vary as } B_G(x) = B_G(0) \frac{R_{\text{bend}}}{R_{\text{bend}} + x}$$

[Otherwise the vertical dispersion y_G would be a function of x .]

Momentum Analyzing Power

To use the vertical dispersion of a guided, bent solenoid to measure momentum, must measure the vertical displacement of the **guiding ray**.

Model: $\delta y_G = \delta R_{\text{curv}} = R_{\text{curv}}^2 \delta k$, where $k = 1/R_{\text{curv}}$.

Uncertainties: δk_{res} (detector resolution) and δk_{ms} (multiple scattering).

$$\delta k_{\text{res}} = \frac{\sigma_{x,D}}{L^2 \sin^2 \theta} \sqrt{\frac{720}{N}}, \quad \delta k_{\text{ms}} = \frac{16 \text{ [MeV}/c]}{LP\beta \sin^2 \theta} \sqrt{\frac{L}{X_0}},$$

for $N \gg 1$ points over length L in medium with radiation length X_0 .

$\sigma_{x,D}$ = spatial resolution of each measurement.

θ = angle between the muon trajectory and its guiding ray.

Let $n = \text{ions/cm}$ in gas, so $N = nL$. Then

$$\delta y_{G,\text{res}} = \left(\frac{P \sin \theta}{eB_s} \right)^2 \frac{\sigma_{x,D}}{L^2 \sin^2 \theta} \sqrt{\frac{720}{nL}} = \left(\frac{P}{eB_s} \right)^2 \frac{\sigma_{x,D}}{L^{5/2}} \sqrt{\frac{720}{n}},$$

$$\delta y_{G,\text{ms}} = \left(\frac{P \sin \theta}{eB_s} \right)^2 \frac{16 \text{ [MeV/c]}}{LP\beta \sin^2 \theta} \sqrt{\frac{L}{X_0}} = \left(\frac{P}{eB_s} \right)^2 \frac{16 \text{ [MeV/c]}}{P\beta} \sqrt{\frac{1}{LX_0}}.$$

Design so multiple scattering is less important. Then

$$\frac{\sigma_{P,D}}{P} \approx \frac{1}{\theta_{\text{bend}}} \frac{P}{eB_s} \frac{\sigma_{x,D}}{L^{5/2}} \sqrt{\frac{720}{n}}.$$

\Rightarrow Resolution better at higher B_s even though $\Delta y_G \propto 1/B_s$.

Resolution $\propto 1/(B_s L^{5/2}) \Rightarrow$ can trade long L for lower B_s .

Limits on Radiation Lengths

Low multiple scattering in detector \Rightarrow

$$\delta y_{G,\text{ms}} < \delta y_{G,\text{res}} \quad \Rightarrow \quad X_0 > \frac{n}{720} \left(\frac{16 \text{ [MeV/c]}}{P\beta} \right)^2 \frac{L^4}{\sigma_{x,D}^2}.$$

But also have problem if multiple scatter in bend.

$$\frac{\delta P}{P} = \frac{eB_s}{P} \frac{\delta y_G}{\theta_{\text{bend}}} \quad (\delta y_G = \text{displacement of guiding ray}).$$

Multiple scattering \Rightarrow change in R_{curv} of helix, \Rightarrow

$$\delta y_G \approx \delta R_{\text{curv}} = \frac{P}{eB_s} \delta\theta_{\text{ms}}.$$

$$\Rightarrow \quad \frac{\delta P}{P} = \frac{\delta\theta_{\text{ms}}}{\theta_{\text{bend}}} \quad \text{where} \quad \delta\theta_{\text{ms}} = \frac{13.6 \text{ MeV/c}}{P\beta} \sqrt{N_X}.$$

$$\Rightarrow \quad N_X = \frac{L}{X_0} < \left(\frac{(\sigma_{P,D}/P) P\beta\theta_{\text{bend}}}{13.6 \text{ MeV/c}} \right)^2,$$

$$\sigma_{P,D}/P = 0.0014, \quad P = 165 \text{ MeV/c}, \quad \theta_{\text{bend}} \Rightarrow N_X < 0.0002.$$

Scaling Law for Cost of Superconducting Solenoids

Green *et al.*:

$$\text{Cost [M\$]} = 0.52(U \text{ [MJ]})^{0.66}.$$

Estimate :
$$U \text{ [MJ]} = \int \frac{B^2 dvol}{2\mu_0} \approx 2(B_s \text{ [T]} R_s \text{ [m]})^2 L_s \text{ [m]},$$

R_s, L_s = radius, length of the solenoid.

$$\Rightarrow \text{Cost [M\$]} = 0.82(B_s \text{ [T]} R_s \text{ [m]})^{1.32} (L_s \text{ [m]})^{0.66}.$$

\Rightarrow minimize $B_s R_s$ to minimize cost.

Minimum Solenoid Radius

$$\text{Transport loss} > 0.001 \Rightarrow R_s > 3.3\sigma_{R,\max} = 3.3\sqrt{\sigma_x^2 + \sigma_{y_{\max}}^2}.$$

For a beam of emittance ϵ_x in a **straight solenoid** with betatron parameter β^* ,

$$\sigma_{x,\text{waist}} = \sqrt{\epsilon_x\beta^*}, \quad \sigma_{x',\text{waist}} = \sigma_\theta = \sqrt{\frac{\epsilon_x}{\beta^*}}.$$

Helices have $R_{\text{curv}} \approx \frac{P\theta}{eB_s}$, and $\sigma_{R_{\text{curv}}} = \frac{\sqrt{2}P}{eB_s}\sigma_\theta = \frac{\sqrt{2}P}{eB_s}\sqrt{\frac{\epsilon_x}{\beta^*}}.$

$$\sigma_{x,\max} \approx \sqrt{\sigma_{x,\text{waist}}^2 + \sigma_{R_{\text{curv}}}^2}.$$

\Rightarrow Minimum beam size when two terms are equal,

$$\Rightarrow \beta^* \text{ [m]} = \frac{2P}{eB_s} = \frac{P \text{ [MeV/c]}}{150B_s \text{ [T]}}, \quad \text{and} \quad \sigma_{R,\max} \text{ [m]} = 2\sqrt{\frac{2P\epsilon_x}{eB_s}}.$$

Beam Size in a Bent Solenoid

In case of horizontal bend, the beam is dispersed vertically.

⇒ Add rms vertical dispersion in quadrature:

$$\sigma_{y,\text{disp}} \approx \frac{P}{eB_s} \frac{\sigma_P}{P}.$$

$$\Rightarrow \sigma_{R,\text{max}} \approx \sqrt{\left(\frac{P}{eB_s} \frac{\sigma_P}{P} \theta_{\text{bend}}\right)^2 + \frac{8P\epsilon_x}{eB_s}}.$$

Then $R_s > 3.3\sigma_{R,\text{max}} \Rightarrow$

$$\frac{P}{eB_s} = \sqrt{\left(\frac{4\epsilon_x}{\theta_{\text{bend}}(\sigma_P/P)^2}\right)^2 + \frac{1}{\theta_{\text{bend}}}\left(\frac{R_s}{3.3(\sigma_P/P)}\right)^2} - \frac{4\epsilon_x}{\theta_{\text{bend}}(\sigma_P/P)^2}.$$

[Complicated, so verify with numerical simulation!]

Choice of Solenoid Parameters

Solenoid must contain the RF timing cavity.

At 800 MHz, a natural radius is 14.6 cm (discussed later).

Choose $R_s = 10$ cm, so RF kick at R_s is 1/2 that at $r = 0$.

Then with $P = 165$ MeV/ c , $\sigma_P/P = 0.05$, $\epsilon_x = 800\pi$ mm-mrad, and $\theta_{\text{bend}} = 1$ rad, analytic model suggests $B_s = 4$ T.

Numerical simulation suggests can use $B_s = 3$ T.

Solenoid Parameters

$$B_s = 3 \text{ T.}$$

Physical $R_s = 15 \text{ cm}$ (beam $R_s = 10 \text{ cm}$).

Four bent solenoid spectrometers, each of total length $L = 3\text{-}4 \text{ m}$.

$$\text{Cost} = 0.82(4 \cdot 0.15)^{1.32} \cdot 4^{0.66} = 0.71 \text{ M\$} \quad (R_s = 15 \text{ cm}, L = 4 \text{ m.})$$

$$\beta_{\text{optimal}}^* = \frac{P \text{ [MeV/c]}}{150 B_s \text{ [T]}} = \frac{165}{150 \cdot 3} = 0.367 \text{ m,}$$

$$\sigma_x = \sqrt{\epsilon_x \beta^*} = 1.7 \text{ cm} \quad \text{and} \quad \sigma_{x'} = \sqrt{\frac{\epsilon_x}{\beta^*}} = 47 \text{ mrad,}$$

for $\epsilon_x = 800\pi \text{ mm-mrad}$.

Numerical Simulation

Track 200 muons from Gaussian distribution with $\epsilon_x = \epsilon_y = 800\pi$ mm-mrad through 8-m-long bent solenoid.

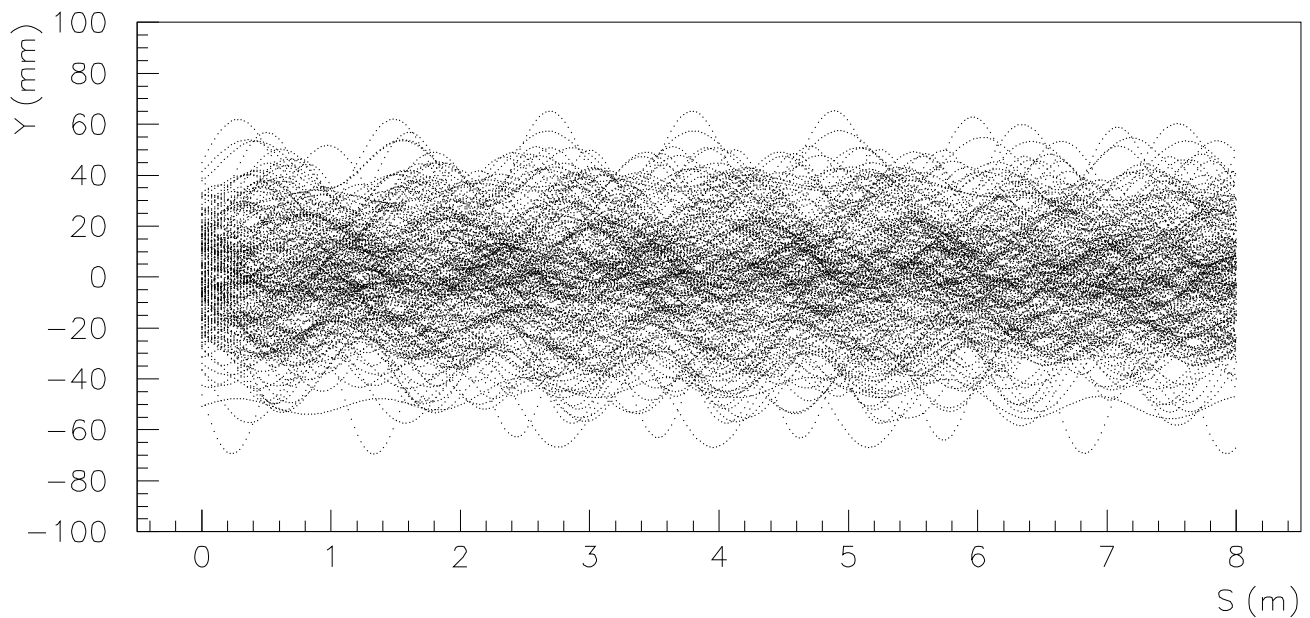
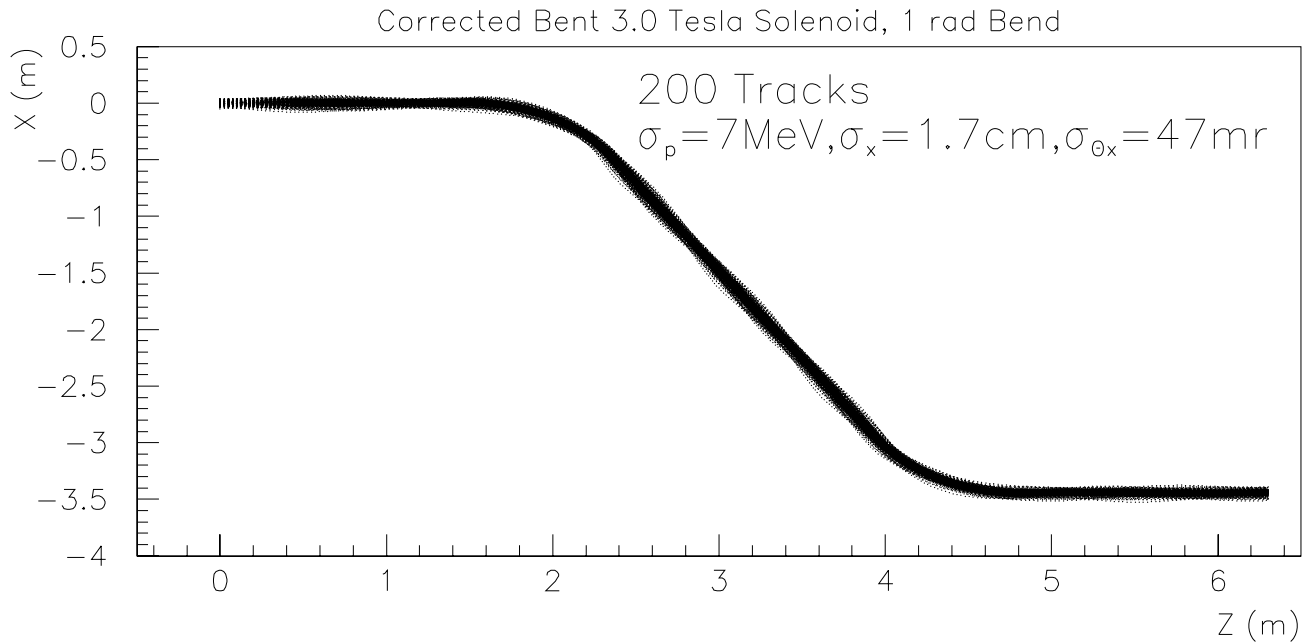

No vertical drift! $\lambda_B = 1.15$ m visible.

Some Growth of Both σ_x and σ_y in Bent Solenoid

Bent Corrected 3.0 Tesla Solenoid. 1 rad. Bend

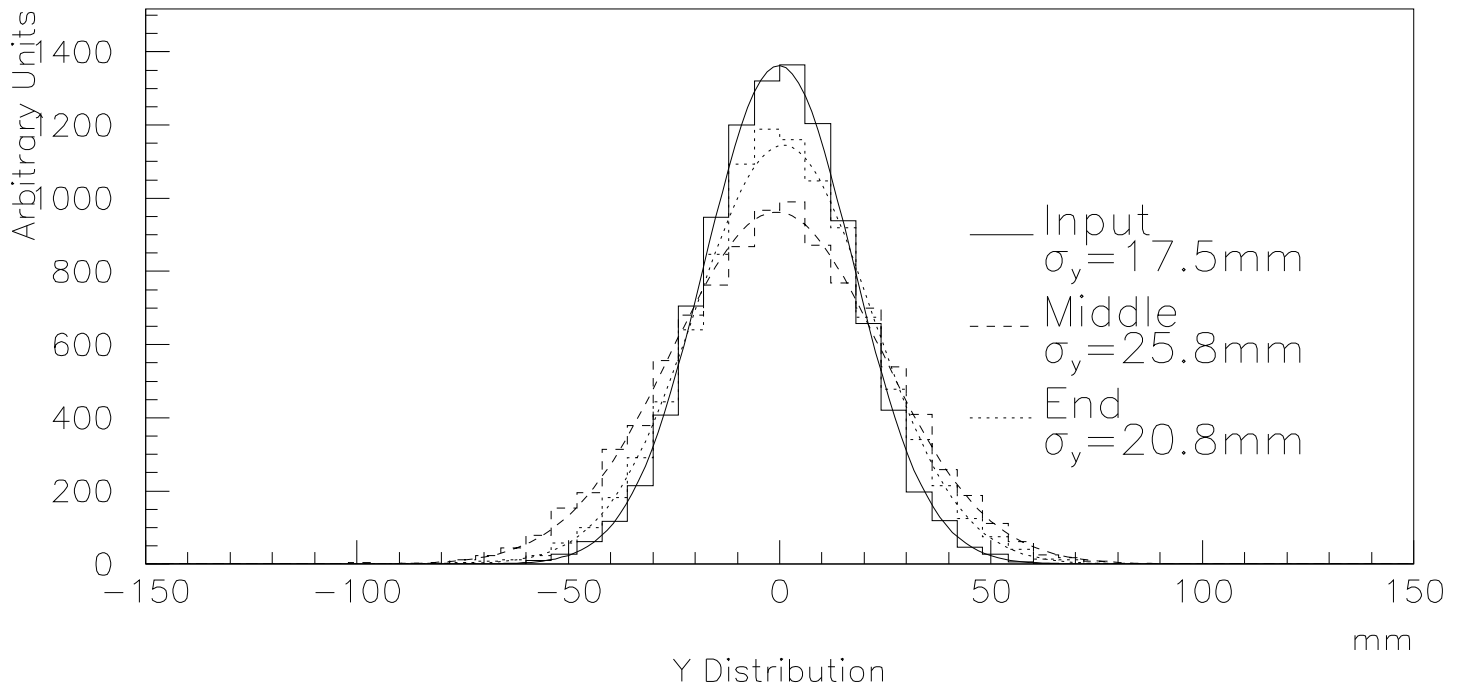
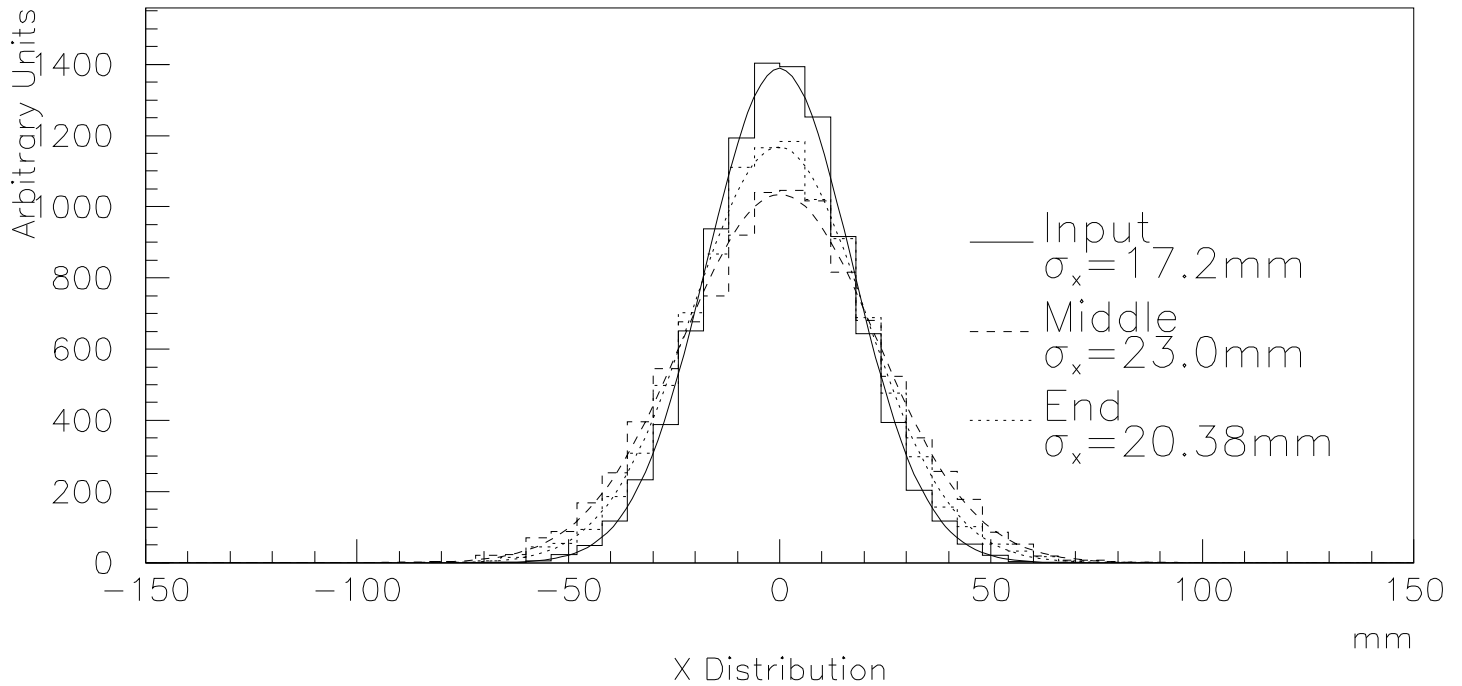

$$\sigma_{R,\max} = \sqrt{\sigma_{x,\max}^2 + \sigma_{y,\max}^2} = 3.46 \text{ cm.}$$

99.9% of Beam at $R < 10$ cm

Bent Corrected 3.0 Tesla Solenoid. 1 rad. Bend

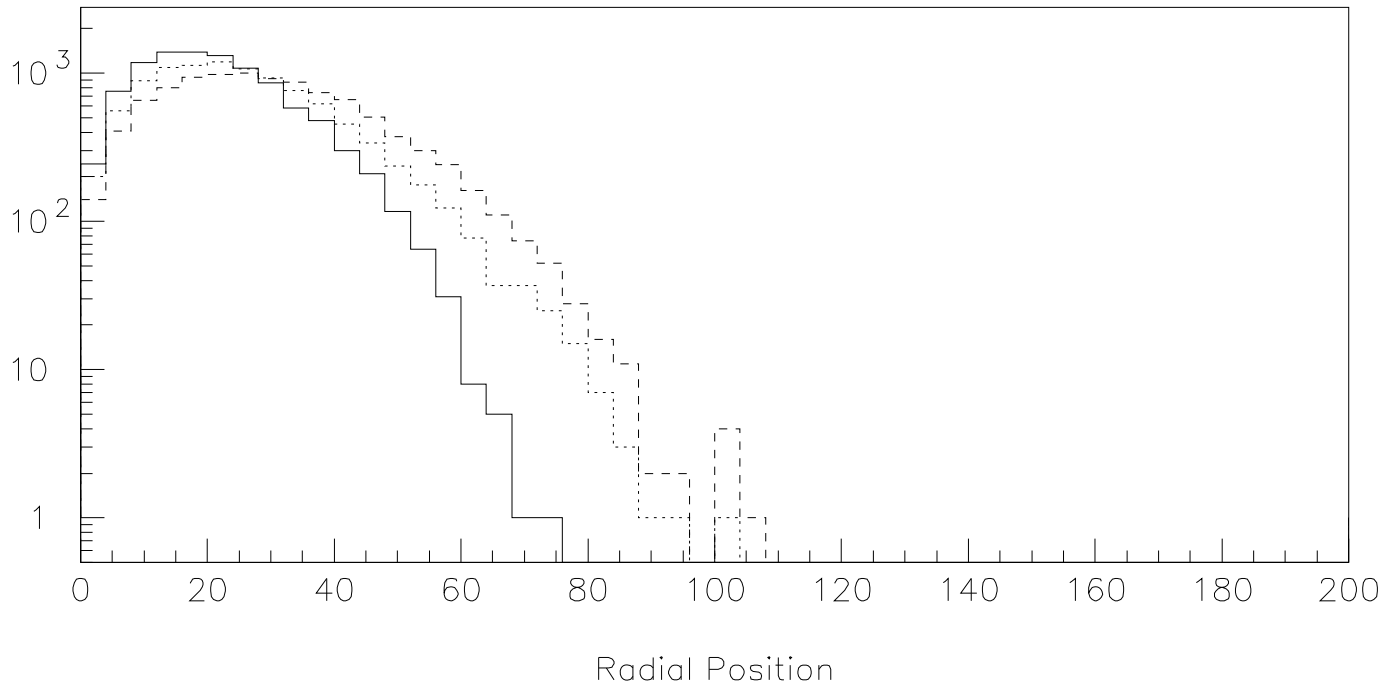
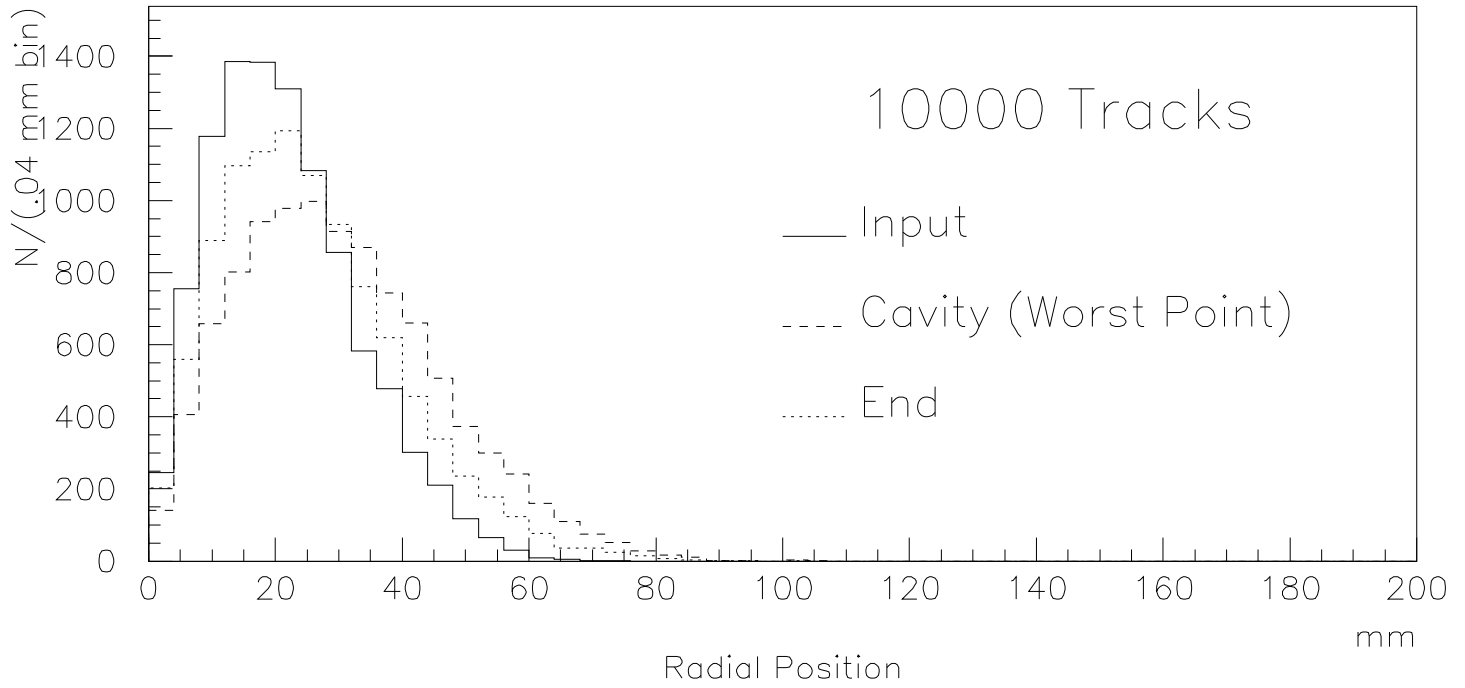

Vertical Momentum Dispersion in a Bent Solenoid

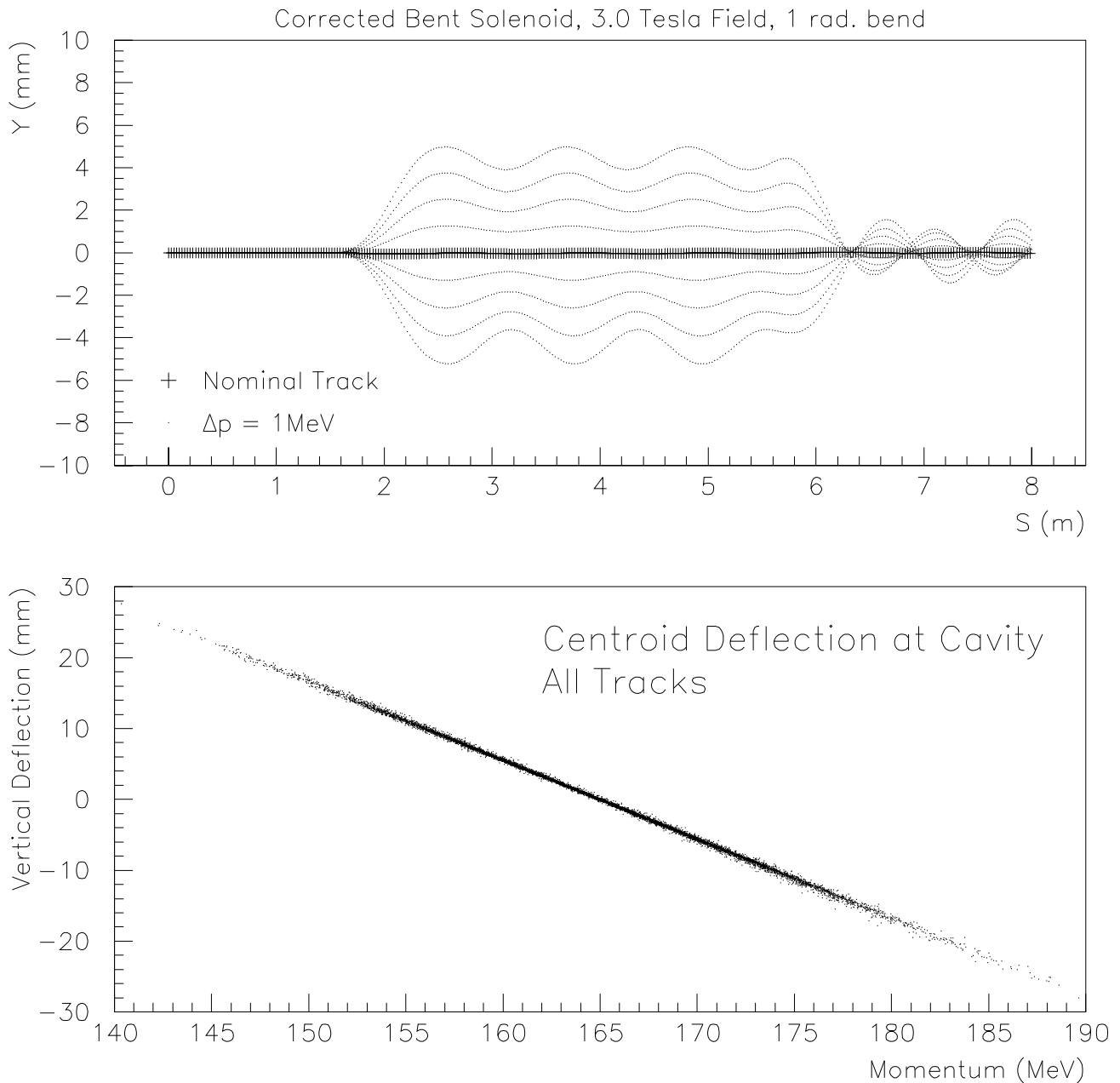

Top: initial muons along axis, but in increments of $\Delta P = 1$ MeV/ c .

Bottom: Δy_G vs. P . (Finite thickness due to 'grad- B drift'.)

Beam Broadening Larger with a 1.5-T Bent Solenoid

Bent Corrected 1.5 Tesla Solenoid. 1 rad. Bend

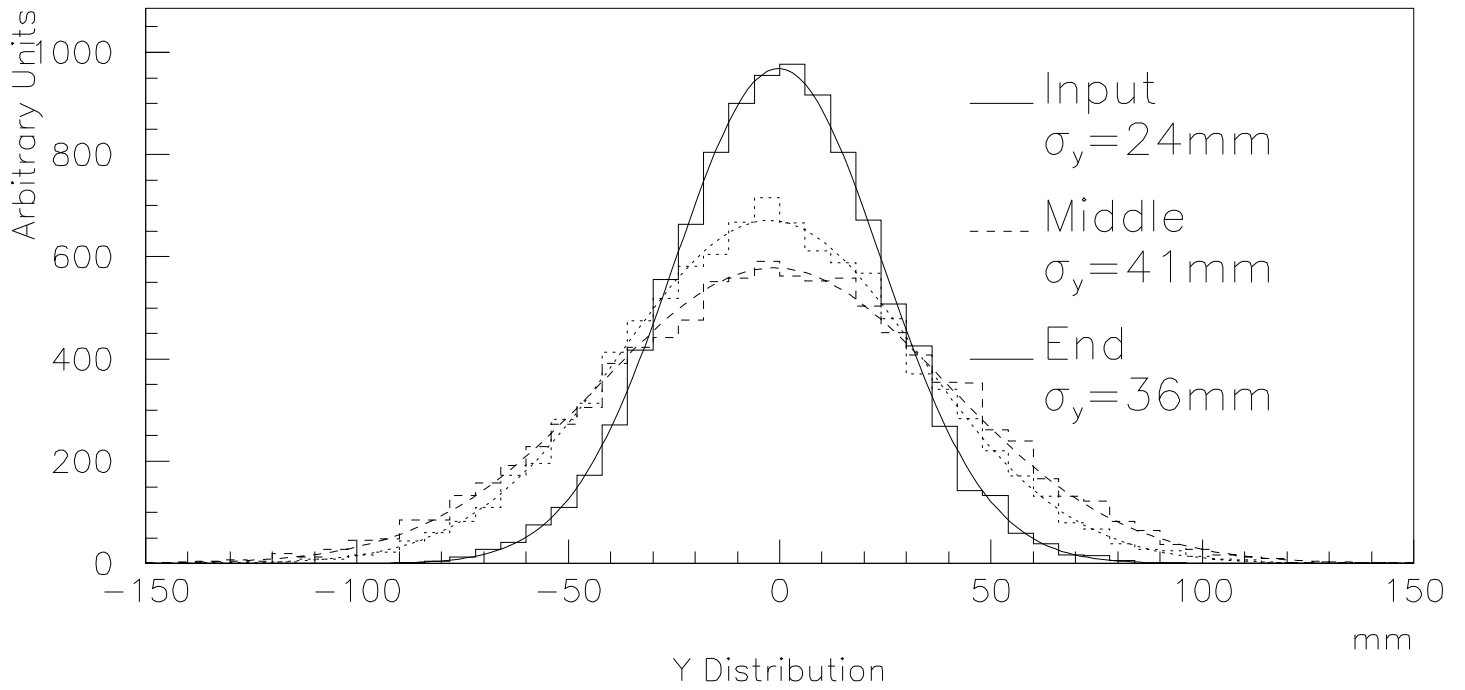
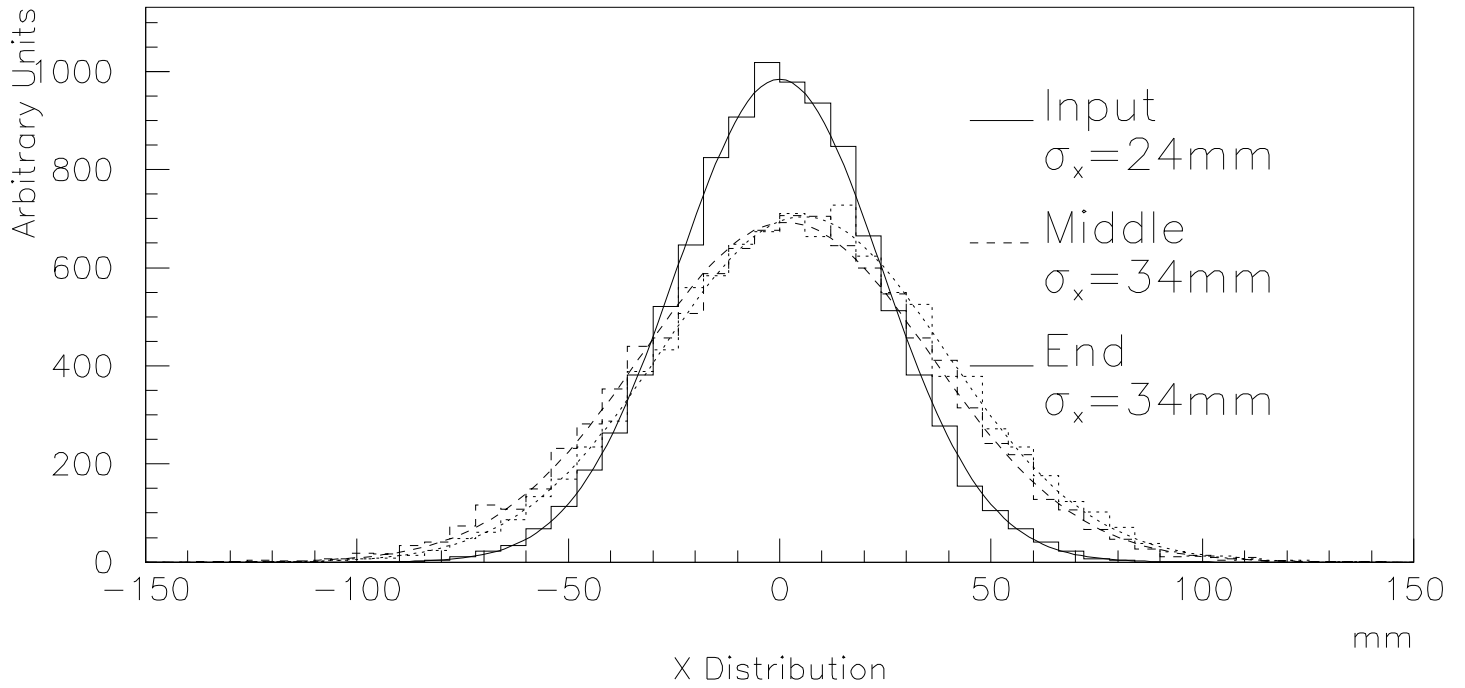

Optimization of β^* at $B = 1.5$ T

β^* Study, 1.5 Tesla Field, 1 radian Bend

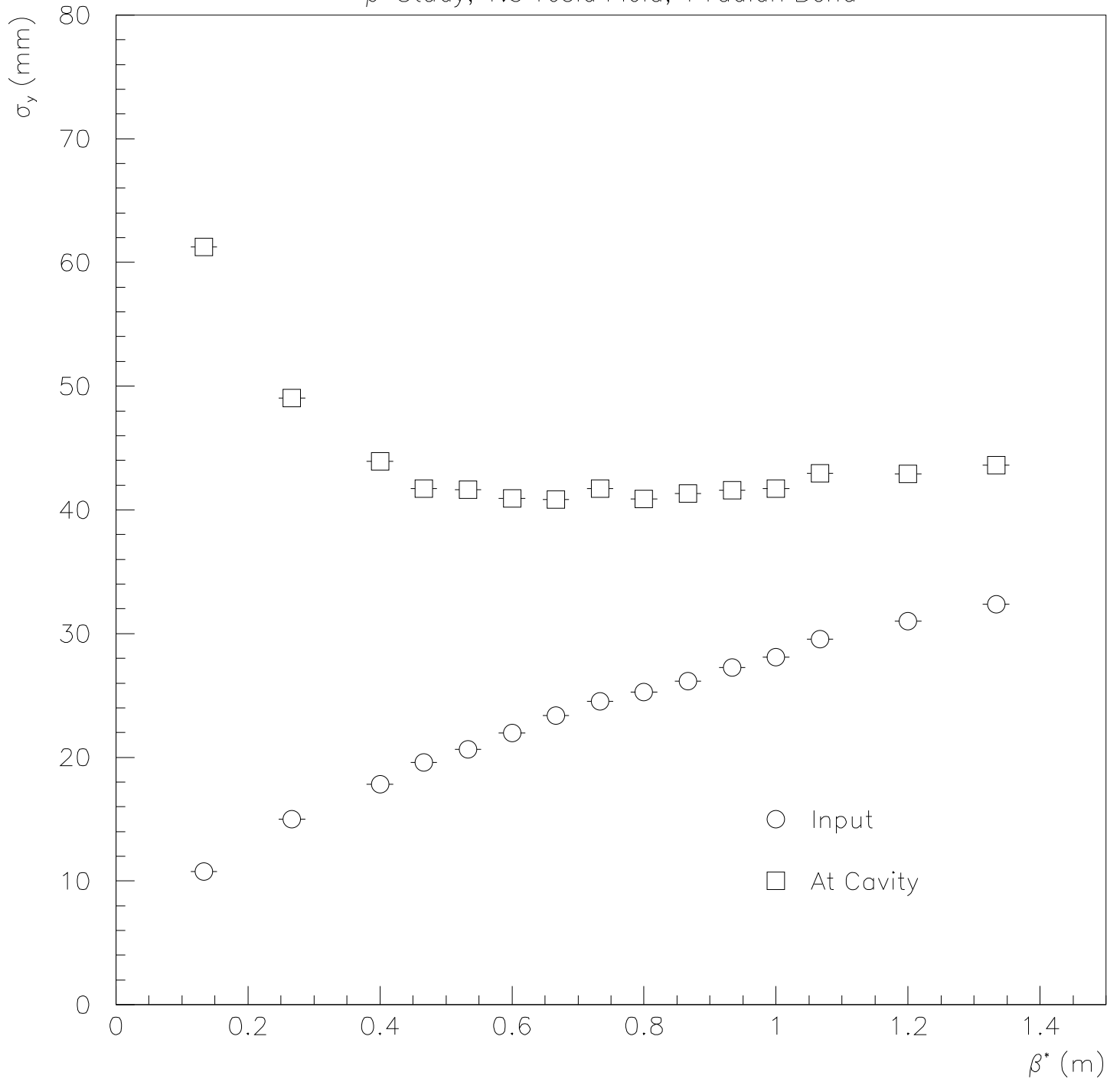

Confirms
$$\beta_{\text{optimal}}^* = \frac{P \text{ [MeV/c]}}{150B_s \text{ [T]}}.$$

Apparent Emittance Growth in the Bent Solenoid

Naively, $\epsilon_{\perp} = \sigma_x \sigma_y \sigma_{P_x} \sigma_{P_y}$. By this measure,

$$\epsilon_{\perp, \text{in}} = 1.72 \cdot 1.75 \cdot 7.84 \cdot 7.69 = 181.5 \text{ (cm-MeV}/c)^2,$$

$$\epsilon_{\perp, \text{out}} = 2.04 \cdot 2.08 \cdot 8.02 \cdot 8.06 = 274.3 \text{ (cm-MeV}/c)^2.$$

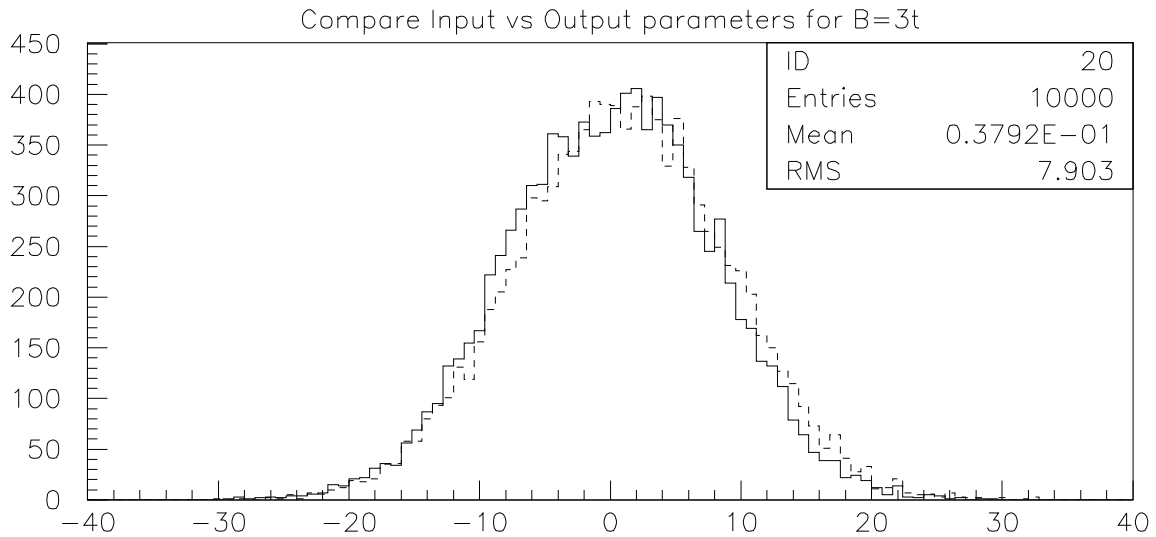

Input P_x Distribution

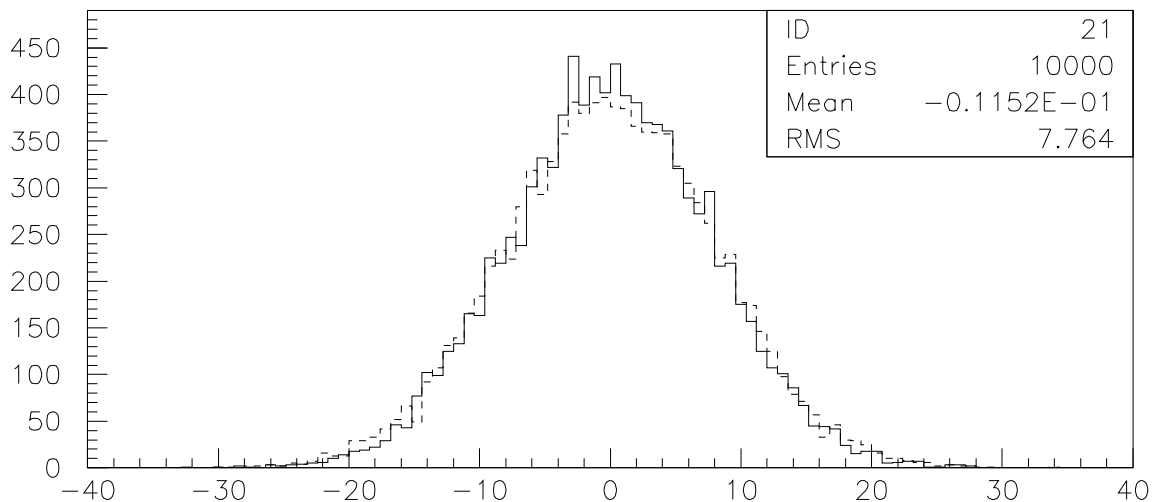

Input P_y Distribution

Improved Emittance Estimate

Calculate off-diagonal 2nd moments, such as $\sigma_{xy}^2 = \langle xy \rangle$.

Only nonzero moments: $\sigma_{xP_y}^2 = 6.25 \text{ cm-MeV}/c$

and $\sigma_{yP_x}^2 = 6.11 \text{ cm-MeV}/c$.

$$\epsilon_{\perp, \text{out}} = \sqrt{(\sigma_x^2 \sigma_{P_y}^2 - \sigma_{xP_y}^4)(\sigma_y^2 \sigma_{P_x}^2 - \sigma_{yP_x}^4)} = 233.3 \text{ (cm-MeV}/c)^2.$$

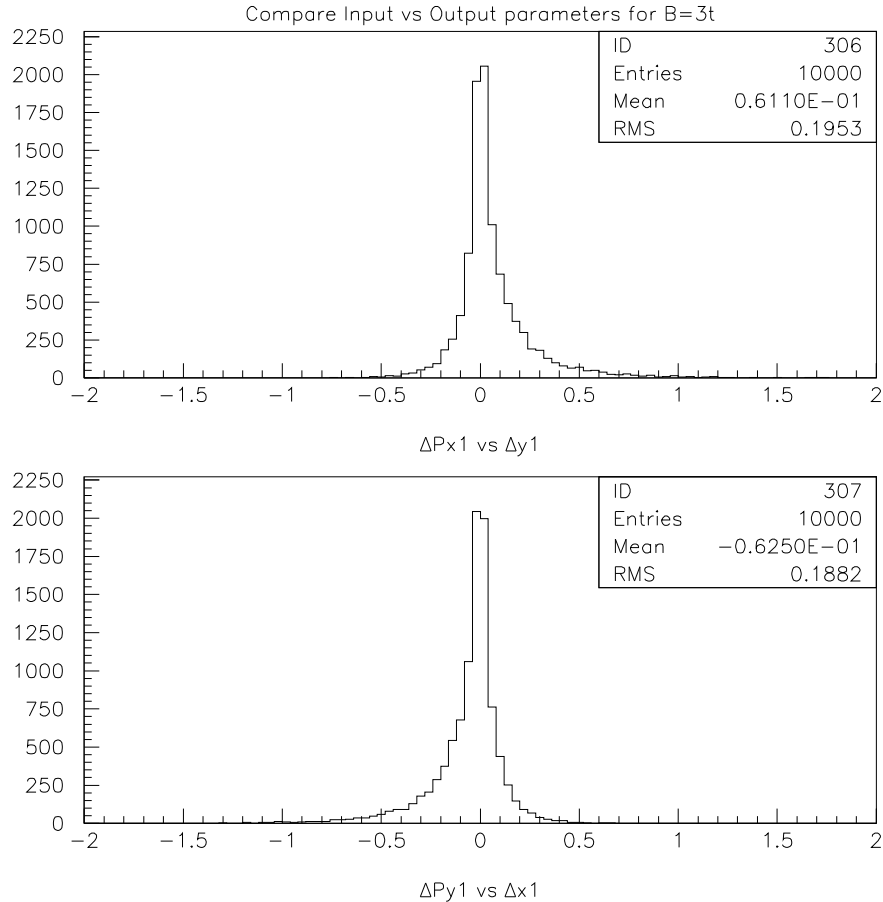

[$\sigma_{xP_y}^2$ and $\sigma_{yP_x}^2$ are the means of the above plots.]

Weighted Sampling

Any beam transport will induce some emittance distortion.

⇒ May have to transport more than 10,000 muons to select a set of 10,000 that represents the desired emittance.

But, can use weights to select desired emittance in software.

(Sample of 10,000 muons) + (Knowledge of losses to 1/1000)

⇒ $0.1 < \text{weight} < 10$.

(Apparent emittance blowup) + weights

⇒ Can start with smaller emittance and let it grow to desired emittance at entrance to cooling channel.

More cost effective to build detector with smaller acceptance and use weights (compared to larger detector, unit weights and longer running time).

Parameters of Tracking Device

$$\text{Optimal: } L_{\text{tracking}} = \left(\frac{1}{\theta_{\text{bend}}} \frac{P}{eB_s} \frac{\sigma_{x,D}}{\sigma_{P,D}/P} \sqrt{\frac{720}{n}} \right)^{0.4} .$$

Number of radiation lengths varies as nL ($n = \text{ions/cm}$).

\Rightarrow Favorable to reduce n at slight increase in L .

Choose $n = 33/\text{m}$ (3.3 cm between ions), at 10-Torr methane.

Then $L_{\text{tracking}} = 43$ cm is length of each TPC.

No. of radiation lengths = 0.000015.

For $B_s = 3$ T, a 165-MeV/ c muon moves through 2.3 radians of azimuth around its helical trajectory for $L = 43$ cm.

TM_{0,1,0} RF Timing Cavity

Studies of the TE_{0,1,1} and TM_{2,1,0} deflection cavities show a very marginal effect.

Consider a cylindrical TM_{0,1,0} cavity of radius a , length b and peak field $E_0 = 40$ MV/m for $\omega = 2\pi 800$ MHz.

Phase the cavity so central particle gains no energy.

Then the (small) energy gain is a linear function of time within the bunch.

Fields:

$$\begin{aligned} E_r &= E_\phi = 0, \\ E_z &= E_0 J_0 \left(\frac{2.405r}{a} \right) \sin \omega t, \\ B_\phi &= E_0 J_1 \left(\frac{2.405r}{a} \right) \cos \omega t, \\ B_r &= B_z = 0. \end{aligned} \tag{1}$$

Dispersion relation:

$$\frac{\omega}{c} = \frac{2.405}{a}, \quad \text{so} \quad d = 2a = \frac{2.405}{\pi} \lambda = 0.766 \lambda = 28.725 \text{ cm.}$$

Energy Gain:

$$\begin{aligned}
 \Delta U &= e \int E_z dz = e\beta_z c \int_{t_{\min}}^{t_{\max}} E_z dt \\
 &= e\beta_z c E_0 \int_{t_{\min}}^{t_{\max}} J_0 \left(\frac{2.405r}{a} \right) \sin \omega t dt \\
 &\approx e\beta_z c E_0 \int_{t_{\min}}^{t_{\max}} \sin \omega t dt = \frac{\beta_z c e E_0}{\omega} (\cos \omega t_{\min} - \cos \omega t_{\max}) \\
 &\approx -\frac{\beta_z c e E_0}{\omega} \frac{2\omega z_0}{\beta_z c} \sin \frac{\omega b}{2\beta_z c} = -2 \sin \frac{\omega b}{2\beta_z c} e E_0 z_0 \\
 &= -2e E_0 \sin \frac{\omega b}{2\beta_z c} \beta_z c \Delta t,
 \end{aligned}$$

$U \Delta U = c^2 P \Delta P \Rightarrow$ **Relative momentum change:**

$$\begin{aligned}
 \frac{\Delta P}{P} &= \frac{2e E_0 \beta_z c \Delta t}{\beta c P} \sin \frac{\omega b}{2\beta_z c} \\
 &= \frac{2 \cdot 40 \text{ [Mv/m]} \cdot 3 \times 10^{-4} \text{ [m/ps]} \cdot \Delta t \text{ [ps]}}{165 \text{ [MeV/c]} \cdot c} = 0.00014 \left[\frac{\Delta t}{1 \text{ ps}} \right],
 \end{aligned}$$

using $b = \lambda \beta_z / 3 = 10.5 \text{ cm}$ and $P = 165 \text{ MeV/c}$.

8-Cell Cavity

Consider an 8-cell RF cavity of same design as for cooling FOFO.

We wish to resolve $8 \text{ ps} = 0.2\sigma_t$.

Then the momentum gain is $\Delta P/P = 8 \cdot 8 \cdot 0.00014 = 0.009$.

This is of same order as desired momentum resolution.

Straggling

$$\begin{aligned}\sigma_{P,\text{straggling}} &\approx \frac{2\gamma r_e m_e c^2}{\beta c} \sqrt{\pi N_0 \frac{Z}{A} s \left(1 - \frac{\beta^2}{2}\right)} \\ &\approx 0.5 \text{ [MeV/c]} \sqrt{\left[\frac{s}{1 \text{ g/cm}^2}\right]},\end{aligned}$$

Require $\sigma_{P,\text{straggling}} < \sigma_{P,D} = 0.006P = 1 \text{ MeV/c}$ for $P = 165 \text{ MeV/c}$.

$$\Rightarrow s < \left(\frac{\sigma_{P,D}}{0.5}\right)^2 = \left(\frac{1}{0.5}\right)^2 = 4 \text{ [g/cm}^2\text{]}.$$

\Rightarrow Could have cavity end walls of copper up to 2-3 mm thick.

Need for an Auxiliary Timing Measurement

Previous analysis holds only for t near zero.

In general, momentum kick varies as $\sin(2\pi t/T)$, $T = \text{RF period}$.

\Rightarrow Need auxiliary timing measurement with $\delta t \lesssim T/4 = 300 \text{ ps}$.

Tracking in Low-Pressure Gaseous Detectors

$\sigma_P/P = 0.0014$ at $165 \text{ MeV}/c \Rightarrow X_0 < 0.0002$ radiation lengths.

One meter of air has 0.0033 radiation lengths!

\Rightarrow Use low-pressure gas tracking.

Because mean-free path is longer at low pressure, it is much easier to obtain gas gain.

Both Townsend coefficient and drift velocity scale as E/P .

[E = electric field, P = pressure.]

\Rightarrow Low-pressure chambers are more ‘natural’ than atmospheric pressure chambers.

Pure Hydrocarbon gases preferred because of greater immunity to UV-photon feedback.

[Compare AR/isobutane 95/5 at 1 atm, with pure isobutane at 1/20 atm. The argon is largely an unnecessary buffer gas.]

Drift Velocity of Hydrocarbon Gases *vs.* E/P

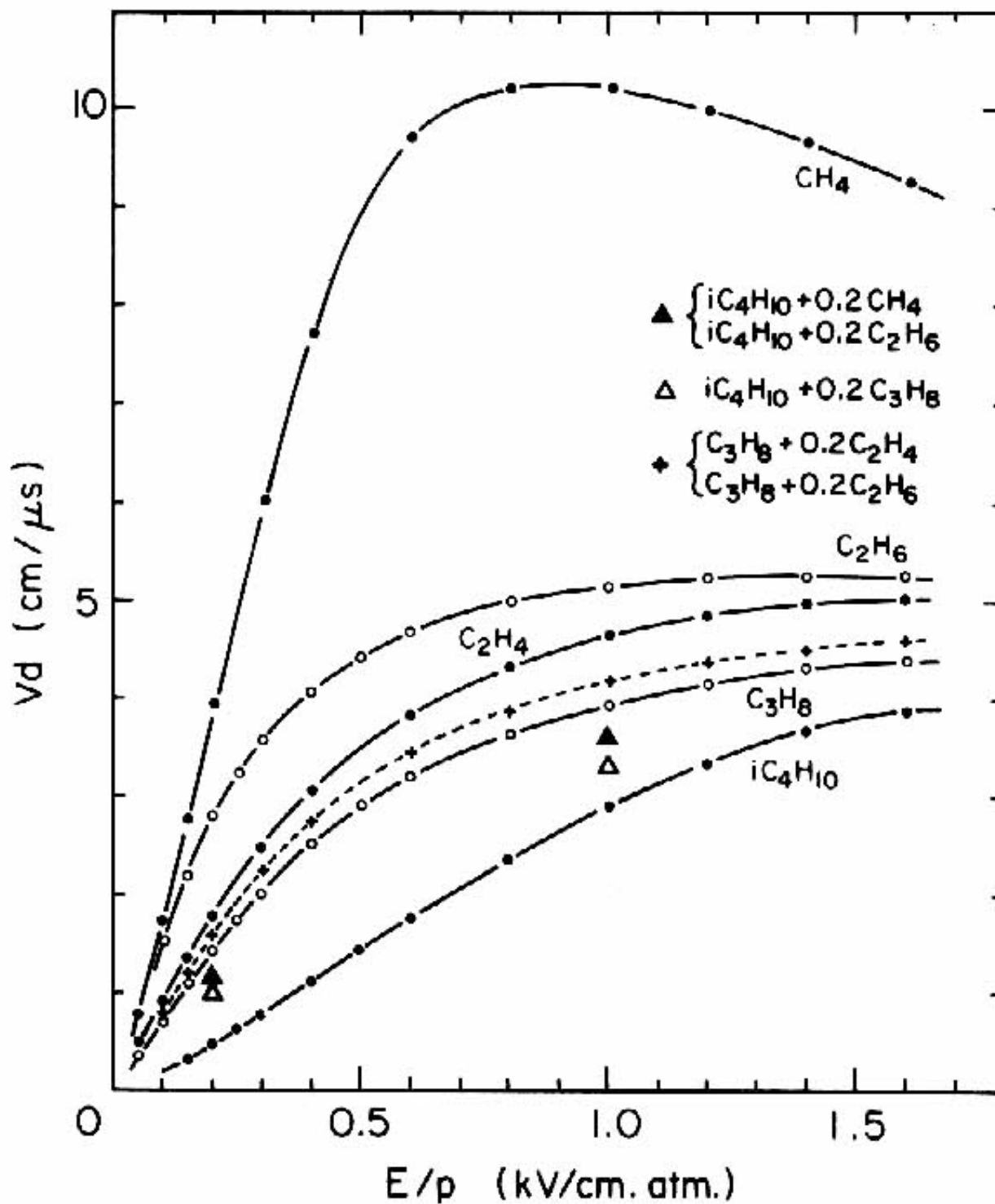

Fig. 185 Lehraus et al. (1982)

Properties of Gases at Low Pressure

| Parameter | Methane | Ethane | Isobutane |
|---|----------|---------|-----------|
| Atomic number | 16 | 30 | 58 |
| Primary clusters/cm (1 atm., 20°C) | 30 | 49 | 100 |
| Pressure (Torr, 20°C) | 8.4 | 5.2 | 2.5 |
| Pressure (Torr, 77°K) | 2.2 | – | – |
| Primary clusters/cm | 1/3 | 1/3 | 1/3 |
| Boiling temp. (°K, 1 atm.) | 112 | 185 | 231 |
| Boiling temp. (°K, 10 Torr) | 77.7 | 130 | 195 |
| Boiling temp. (°K, 1 Torr) | 67.3 | 114 | 172 |
| Radiation lengths/m | 0.000017 | 0.00002 | 0.00002 |
| Saturation E field (V/cm) | 10 | 8.8 | 6 |
| Saturation drift velocity ($\mu\text{m}/\text{ns}$) | 100 | 50 | 40 |
| Drift time over 45 cm (μsec) | 4.5 | 9.0 | 11.25 |

Time Projection Chamber

In a high magnetic field, most convenient if \mathbf{E} parallel \mathbf{B} .

Low-mass chamber \Rightarrow Minimize walls \Rightarrow **Single drift region.**

0.3 cluster/cm \Rightarrow Need \approx **45 cm path length** for good tracking.

\Rightarrow Use small **Time Projection Chamber** (TPC).

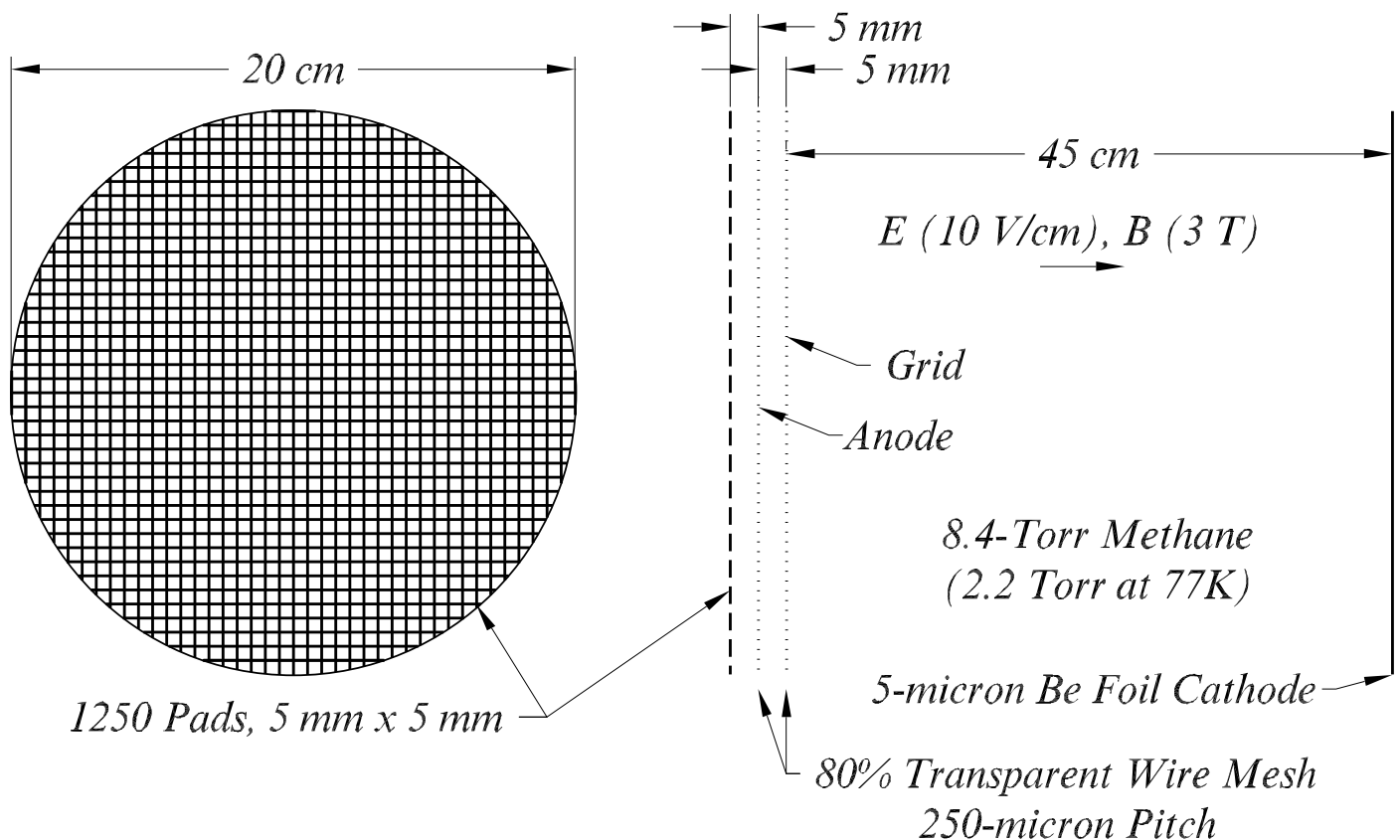

2 TPC's per momentum spectrometer \times 4 spectrometers

\Rightarrow Total of 8 TPC's.

Use Multistep Chamber If Need Gain $> 10^6$

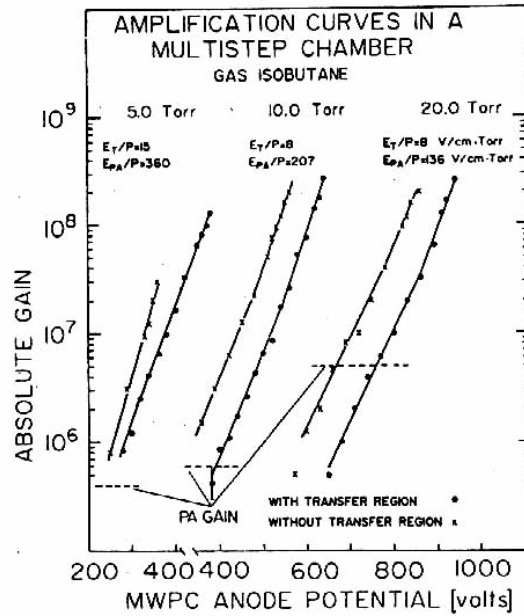
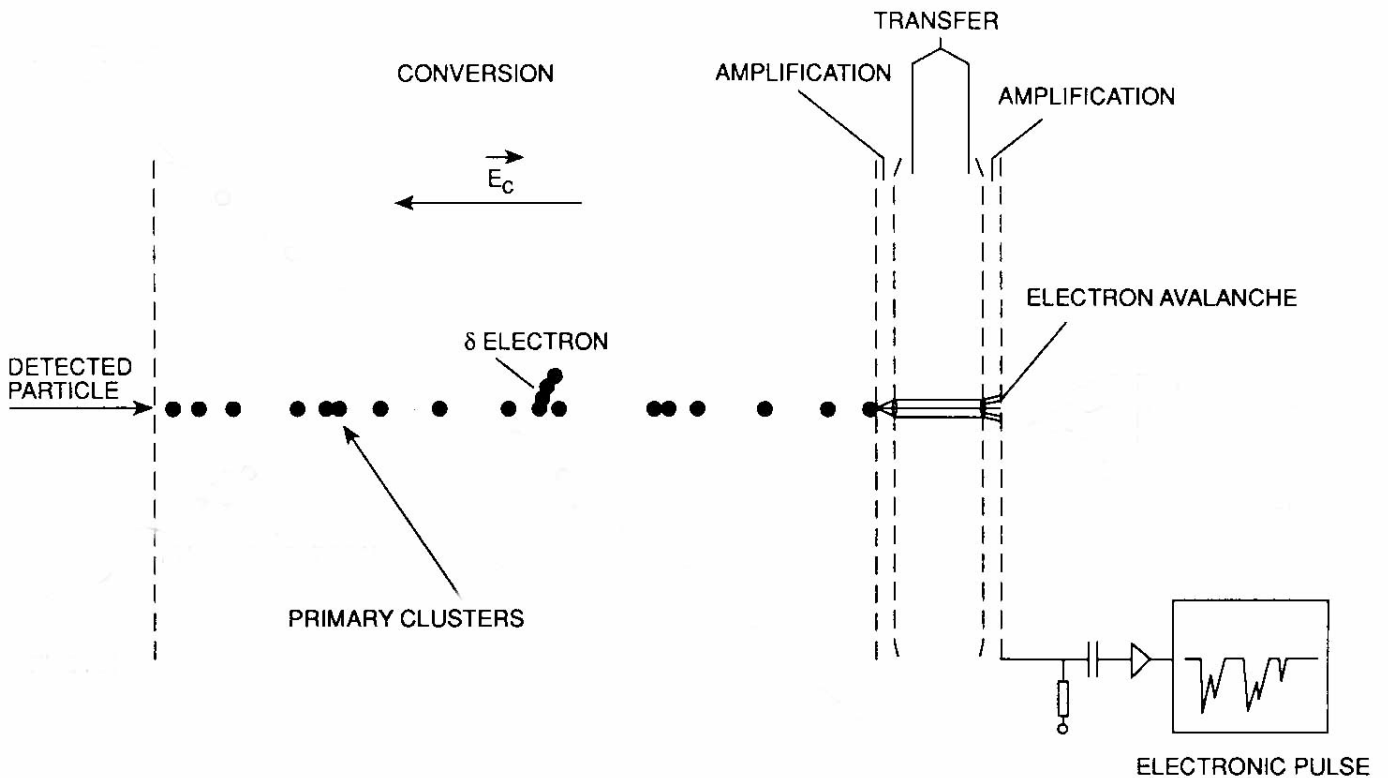

Fig. 2. Amplification curves for a MSC operated with isobutane at pressures of 5, 10 and 20 Torr. The absolute total gain of the MSCs is presented versus the anode potential of the MWPC, for constant values of the preamplification and transfer fields. The amplification factor of the first PPAC stage is represented by dashed lines.



Cathode Pad Readout

Need to measure x , y and z of clusters to reconstruct track.

⇒ Read out signals induced on pads on cathode plane.

Ex: 1250 pads/TPC, $R_{\max} = 10$ cm ⇒ Pad size = 5×5 mm².

Goal: $\sigma_x = \sigma_y = 200$ $\mu\text{m} = 1/25$ pad width.

⇒ Charge-sharing readout must have noise $< 1/25$ average signal.

Readout noise $\approx 10^3$ electrons ⇒ Gas gain = 2.5×10^4 .

Time Sampling

Also want $\sigma_z = 200 \mu\text{m} \Rightarrow \sigma_t = 2 \text{ ns}$ if use **methane**.

\Rightarrow Must sample cathode pads every few $\times 2 \text{ ns}$.

Cluster separation $\approx 3.3 \text{ cm}$,

Saturation drift velocity (methane) is 10^7 cm/s ,

\Rightarrow Average time between clusters = 330 ns ,

\Rightarrow Must sample several times during 330 ns .

Choose 50 MHz sampling frequency (20 ns/sample).

RF flattop $\approx 5 \mu\text{sec}$,

Electron drift over $45 \text{ cm} \approx 5 \mu\text{sec}$,

Total sampling time $\approx 10 \mu\text{sec}$,

$\Rightarrow 500 \text{ samples/pulse}$.

Readout Via Switched Capacitor Array

These requirements are well matched to use of an analog pipeline based on switched capacitor arrays (SCA's):

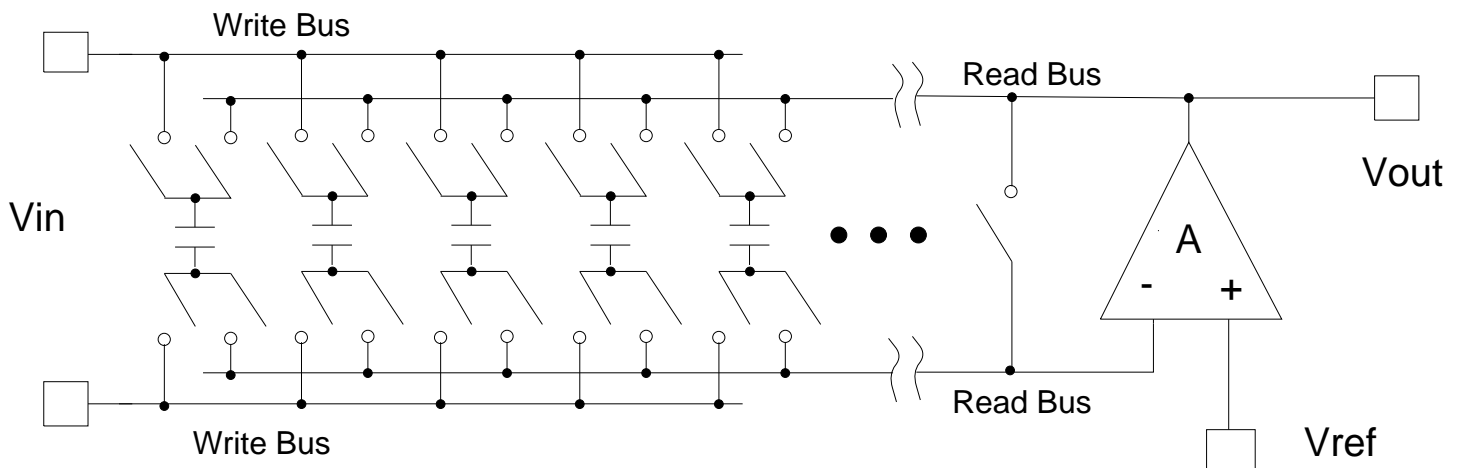

Candidate chip: 16-channel, 512-deep SCA by S. Kleinfelder (LBL).

Could adopt STAR TPC readout.

[IEEE Trans. Nuc. Sci. **NS43**, 1619, 1768 (1996)].

System cost \approx \$33/channel.

SCA Performance

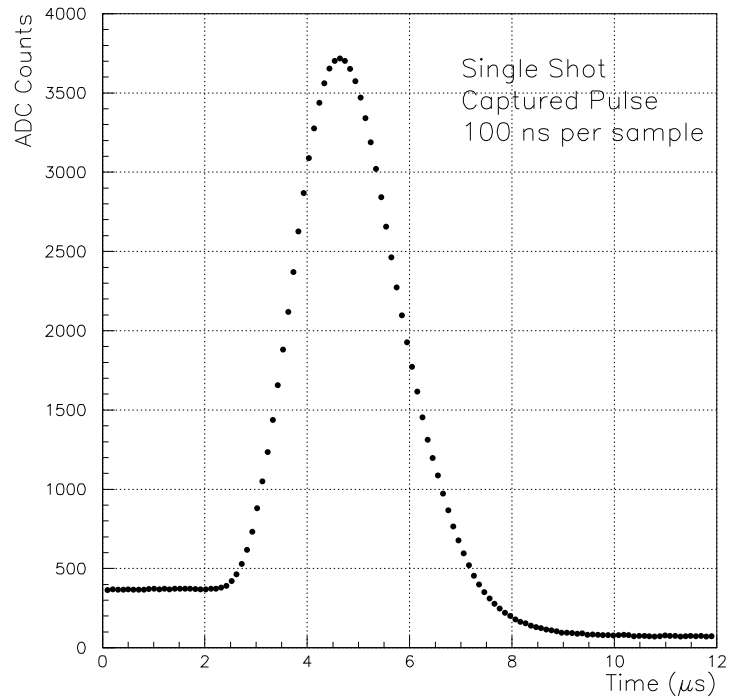

Dynamic range of 12 bits:

Time interpolation to 1/100 of sampling period:

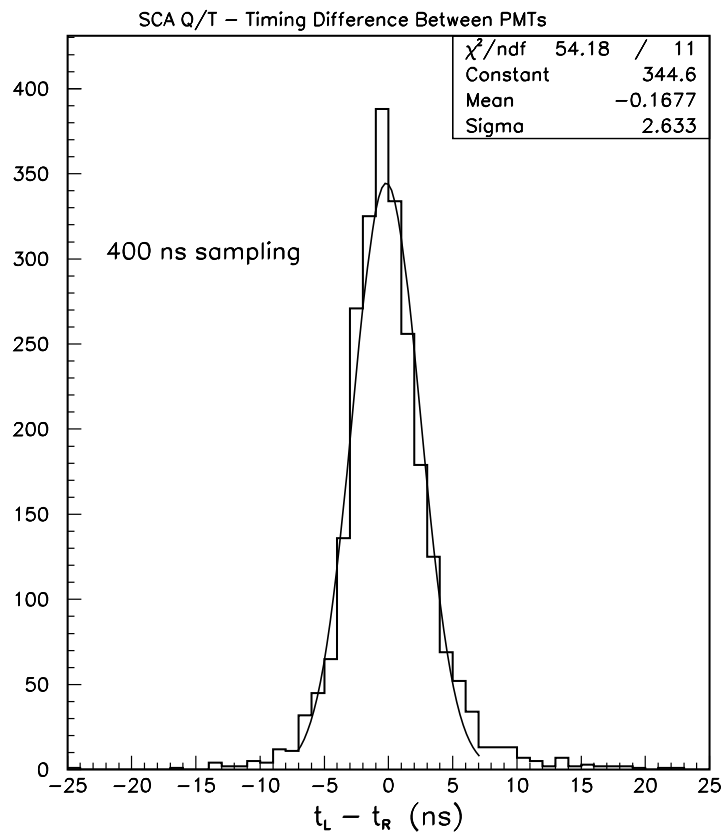

Packaging

Place 80 16-channel preamps and SCA's around circumference of cathode pad plane inside pressure vessel.

ADC's and buffer memory outside pressure vessel.

Rate Capability

Each TPC has $1250 \ x\text{-}y \times 250 \ t$ samples = 300,000 'pixels'.

Each muon track has 20 clusters.

Each cluster occupies $\approx 3^3 = 27$ pixels.

\Rightarrow 500 pixels/track.

Hence 600 muons/pulse \Rightarrow 100% occupancy.

Good muon separation $\Rightarrow \lesssim$ **10 muons/pulse** (1 MHz).

Then data rate \approx 5,000 samples/pulse

= 75,000 samples/sec @ 15 Hz.

Diffusion

Mean free path longer at low pressure \Rightarrow larger diffusion!

Spatial smearing; $\sigma = \sqrt{2Dt} = \sqrt{\frac{2Dz}{v_d}}$.

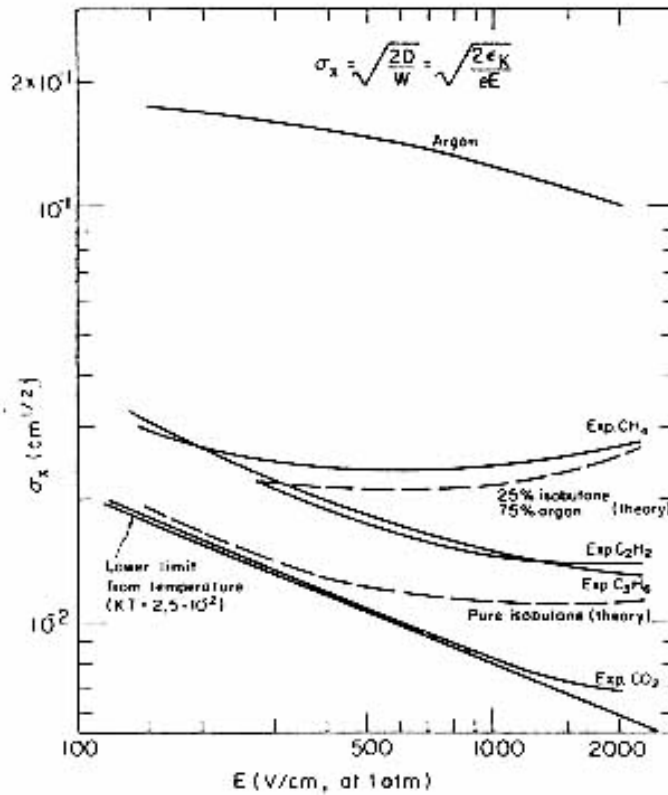

But in a magnetic field, transverse diffusion \ll longitudinal.

Our measurement of P_{\perp} is unaffected by longitudinal diffusion.

$$P = \frac{P_{\perp}}{\tan \theta} \approx \frac{P_{\perp}}{\theta} \quad \Rightarrow \quad \frac{\delta P}{P} = \sqrt{\left(\frac{\sigma_{P_{\perp}}}{P_{\perp}}\right)^2 + \left(\frac{\sigma_{\theta}}{\theta}\right)^2}$$

Longitudinal Diffusion When $\mathbf{E} \parallel \mathbf{B}$

$$D_{\parallel} \approx \frac{v_d k T}{e E} \quad (\text{Einstein}) \quad \Rightarrow \quad D(E, T) = \frac{T}{T_0} \frac{E_0}{E} D(E_0, T_0).$$

$D_{\parallel} = 10^5 \text{ cm}^2\text{s}^{-1}$ at the saturation velocity $v_d = 10^7 \text{ cm/s}$ in methane at 100°K and 0.01 atmosphere.

$$\Rightarrow \quad \sigma_z = \sqrt{\frac{2D_{\parallel} x}{v_d}} \equiv A\sqrt{z}, \quad \text{where} \quad A = 0.135 \text{ cm}^{\frac{1}{2}}.$$

Fit for track angle θ via $u = z/\theta$ where $\hat{\mathbf{u}} \perp \hat{\mathbf{z}}$ and U is measured on the surface of the helix.

$$\chi^2 = \sum_i \frac{(z_i - u_i/\theta)^2}{\sigma_{z_i}^2} = \sum_i \frac{(z_i - u_i/\theta)^2}{A^2 z_i},$$

$$\Rightarrow \quad \frac{1}{\sigma_{\theta}^2} = \frac{\partial \chi^2}{\partial \theta^2}, \quad \text{and hence} \quad \sigma_{\theta} = A\theta \sqrt{\frac{\theta}{Nz}}.$$

$\sigma_{\theta, \text{diffusion}} \approx 0.00006$ for $N = 15$, $z = 45 \text{ cm}$, and $\theta_{\text{rms}} = 0.05$.

\Rightarrow Longitudinal diffusion not a problem.

Transverse Diffusion When $\mathbf{E} \parallel \mathbf{B}$

Field $\mathbf{B} \Rightarrow$ transverse mean free path \lesssim Larmor radius.

$$\Rightarrow D_{\perp} \approx \frac{r_B}{l} D_{\parallel} = \frac{kT}{m\omega_B}.$$

noting $\frac{r_B}{l} = \frac{v_d/\omega_B}{v_d\tau} = \frac{1}{\omega_B\tau} \approx \frac{1}{3000}$, and $v_d \approx \frac{eE}{m}\tau$.

$$\Rightarrow D_{\perp} \approx 33 \text{ cm}^2\text{s}^{-1},$$

using $\omega_B = 1.8 \times 10^{11} \text{ Hz} \times B$ [Tesla], and $B = 3 \text{ T}$.

$$\Rightarrow \sigma_{\perp,\text{diffusion}}(45 \text{ cm}) \approx \sqrt{\frac{2 \cdot 33 \cdot 45}{10^7}} \text{ cm} = 170 \text{ } \mu\text{m}.$$

\Rightarrow Transverse diffusion not a problem.

Diffusion When $\mathbf{E} \perp \mathbf{B}$

Electron drift has component along $\mathbf{E} \times \mathbf{B}$ as well as \mathbf{E} .

Drift $\perp \mathbf{B} \Rightarrow v_d$ reduced by factor $r_B/l \approx 1/3000$.

D_{\parallel} and D_{\perp} as for case $\mathbf{E} \parallel \mathbf{B}$.

\Rightarrow Diffusion much larger because of longer drift time.

Typical drift distance from axis of chamber is $r = 10$ cm.

$$\sigma_{\perp} = \sqrt{\frac{2D_{\perp}r}{v_d}} = \sqrt{\frac{2 \cdot 33 \cdot 10}{3 \times 10^3}} = 0.46 \text{ cm},$$

$$\sigma_{\parallel} = \sqrt{\frac{2D_{\parallel}r}{v_d}} = \sqrt{\frac{2 \cdot 10^5 \cdot 10}{3 \times 10^3}} = 26 \text{ cm}.$$

$\Rightarrow \mathbf{E} \perp \mathbf{B}$ unsuitable for low-pressure, long-drift detector.

Auxiliary Timing Detector

RF timing measurement requires auxiliary timing measurement with $\sigma_t < 300$ ps to resolve ambiguity.

If auxiliary timing detector must reside in 3-T field, consider use of microchannel-plate photomultipliers (MCP-PMT's).

Hamamatsu R3809U: photocathode diameter = 11 mm

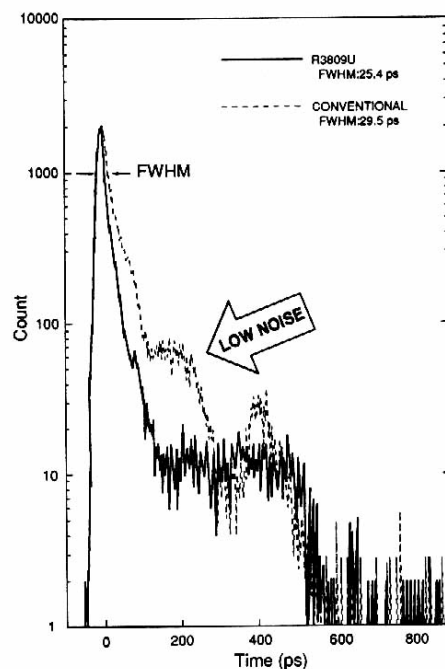
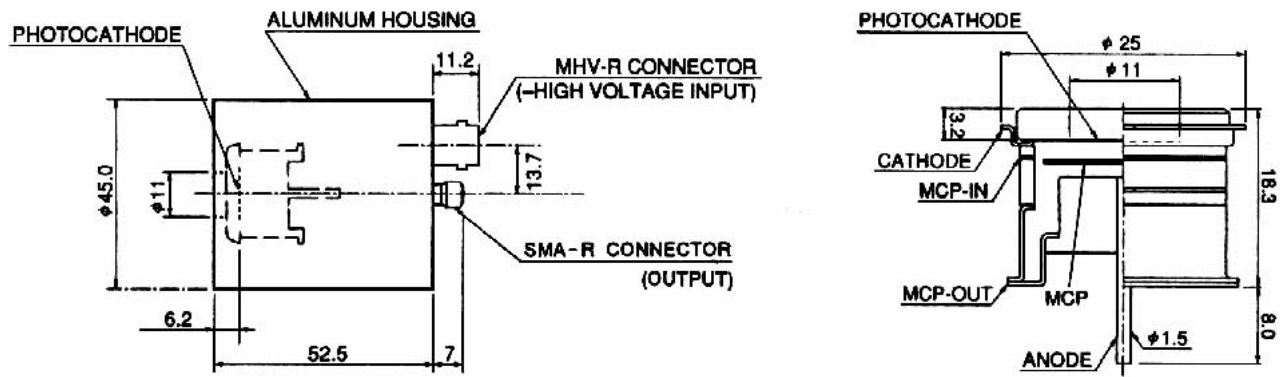

$\sigma_t = 12$ ps in device itself:

Test of MCP-PMT Timing with Čerenkov Light

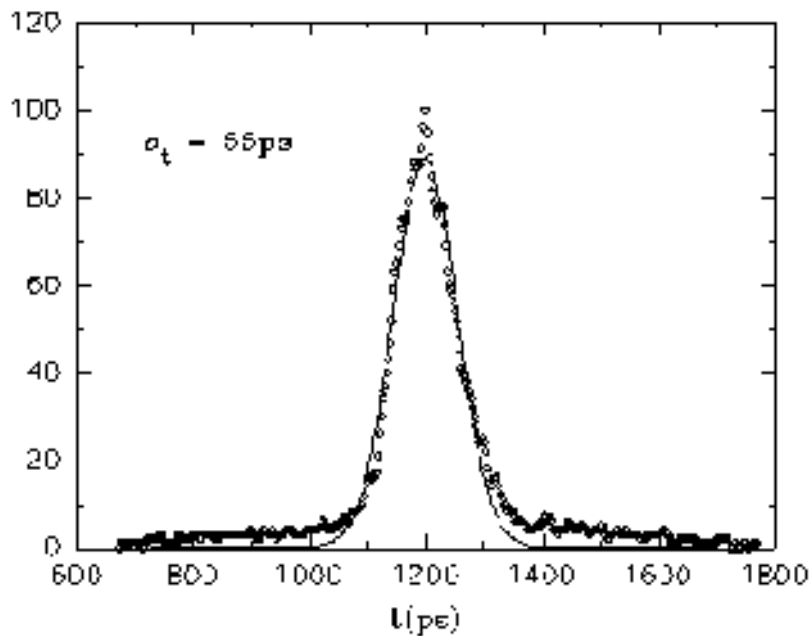
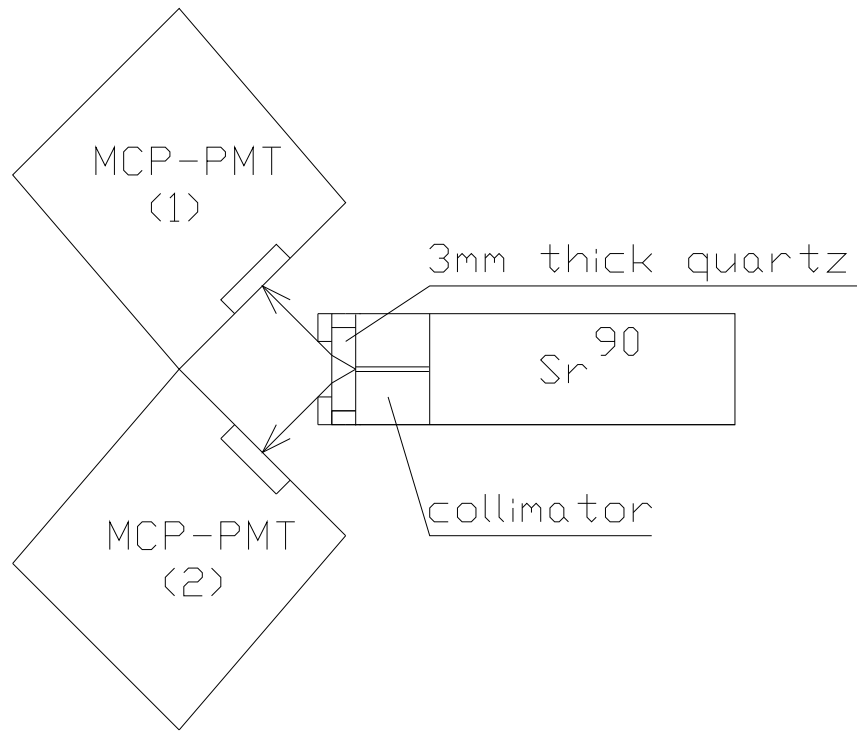

Observed $\sigma_t = 55/\sqrt{2} = 39$ ps per device;

May have been limited by constant-fraction discriminator.

Auxiliary Timing Device Using MCP-PMT's Viewing Čerenkov Light from Quartz Bars

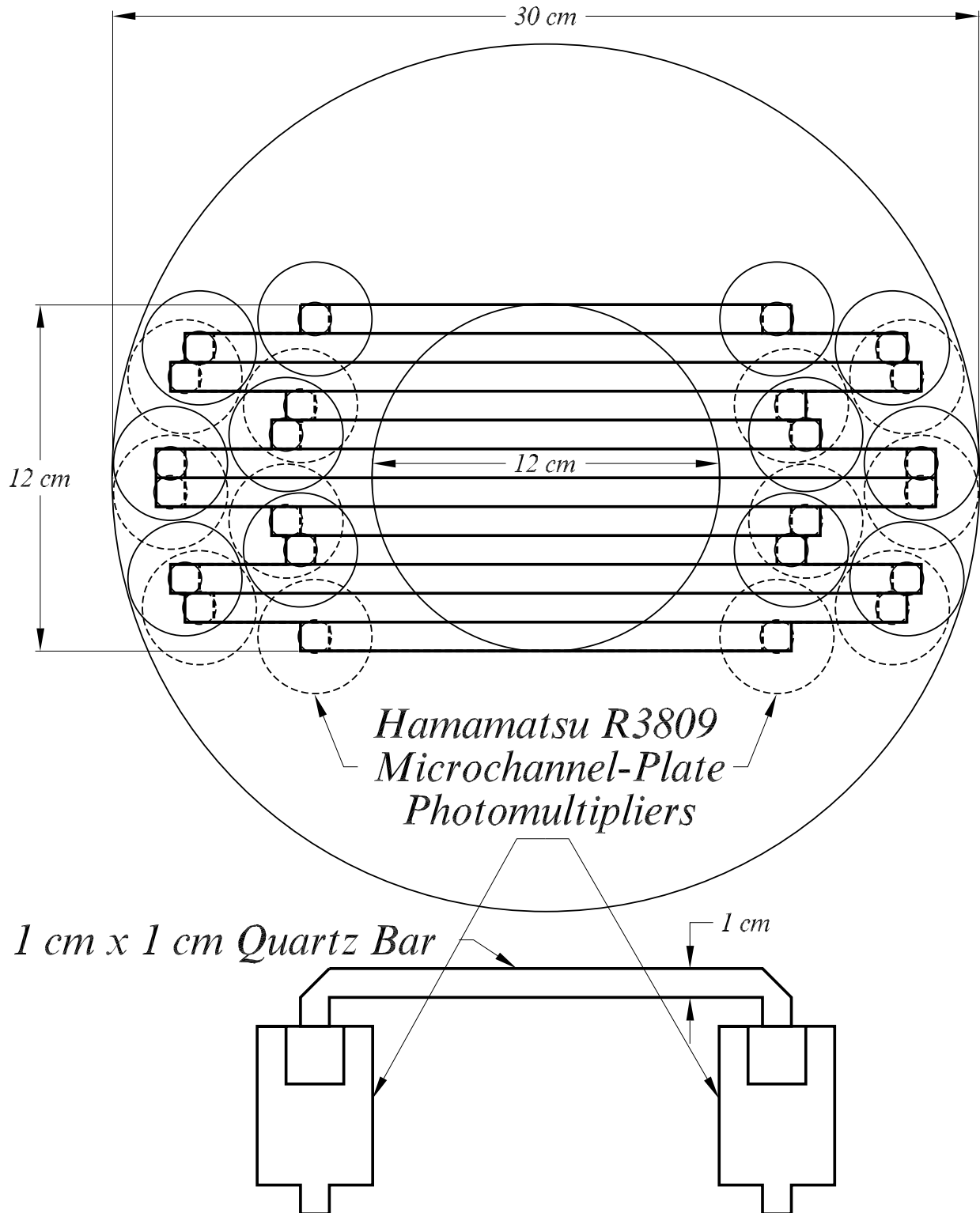

e - μ - π Identification by Time of Flight

Use auxiliary timing device and RF timing cavity.

$$\Delta t = \frac{1}{\beta_1 c} - \frac{1}{\beta_2 c} = \frac{\sqrt{1 + (m_1 c/P)^2} - \sqrt{1 + (m_2 c/P)^2}}{c}.$$

At 165-MeV/ c momentum electrons arrive earlier than muons by 0.625 ns/m and pions arrive later by 0.407 ns/m.

Ambiguity: don't know which half cycle of RF the muon is in,
 \Rightarrow Uncertainty in absolute time in multiples of 625 ps (800Mhz).

Best if both $\Delta t_{e\mu}$ and $\Delta t_{\mu\pi}$ are odd multiples of 312.5 ps.

For $3 > L < 4$ m, best we can do is choose $L = 3.63$ m, for which both the e - μ and the μ - π time differences differ from multiples of 0.625 ns by 230 ps.

If the timing resolution of the auxiliary timing device is 100 ps we would have only 2.3- σ separation between μ 's and e 's or π 's.

\Rightarrow Better to have 50 ps resolution in auxiliary timing device.

Proposed Detector R&D at Princeton

At Princeton we have extensive experience with low pressure gaseous detectors, including characterization of single-electron gain, drift velocity and diffusion (SSC and BABAR).

We propose to build new prototype chambers with TPC geometry, and instrument them with FEE cards from the STAR TPC project. This will require building a FPGA-based control board to interface the readout to a PC.

The prototype chambers will be tested both in zero magnetic field and in a 5-T magnet.

Technical Issues to Be Studied Include:

1. Dynamic range the STAR SCA at 50 MHz (somewhat higher than nominal).
2. Accuracy of time and space interpolation via charge sharing on readout pads.
3. Measurement of gas gain, drift velocity and diffusion at low temperature and pressure for methane and other candidate gases.
4. Verification of detector performance over long drift paths in a strong magnetic field.
5. Viability of placement of readout electronics next to pad plane (inside the magnetic field).