

Meson Production with Different Directional Incident Proton Beam

X. Ding, D. Cline, UCLA

H. Kirk, J. S. Berg, BNL

The Mercury Jet Target Geometry

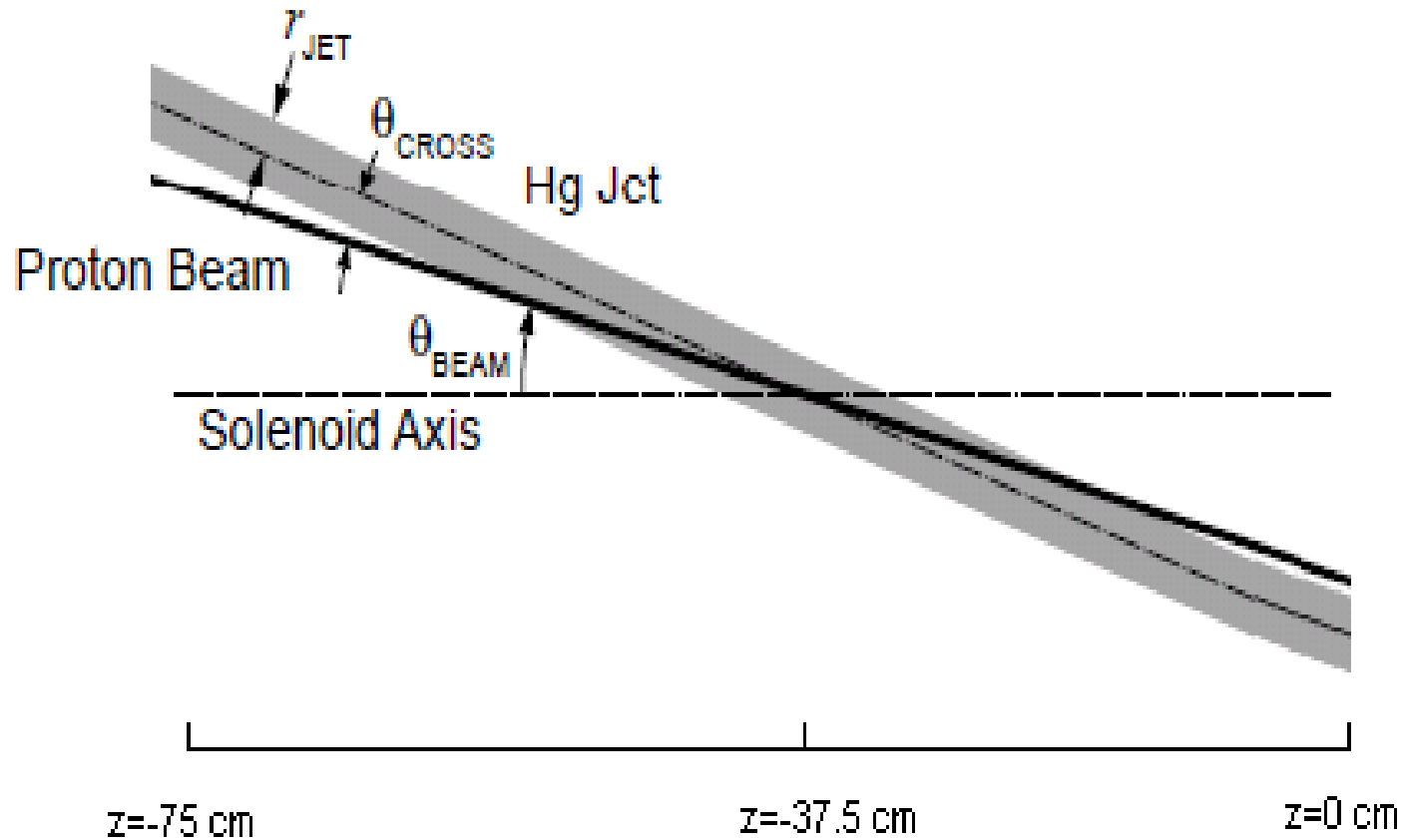

Definitions

- 8GeV, $\theta_j = 96.68\text{mrad}$, $r_j = 0.4\text{cm}$, $\sigma_b = 0.3r_j$
- Roll angle(Φ): Telling us what side of the jet the beam is on. (At $z=-75\text{cm}$, below: $\Phi=\pi$, up: $\Phi=0$, left: $\Phi= \pi/2$, right: $\Phi=3\pi/2$)
- Clearance: Telling us the extent of proton beam away from the Hg jet at $z=-75\text{cm}$.

$$C = \frac{\sqrt{(x_0 - x_j)^2 + (y_0 - y_j)^2} - r_j}{\sigma_b}$$

$$x_j=0, y_j=3.64\text{cm}$$

Same Crossing Angle and 90° Roll Angle Apart at $z=-37.5\text{cm}$

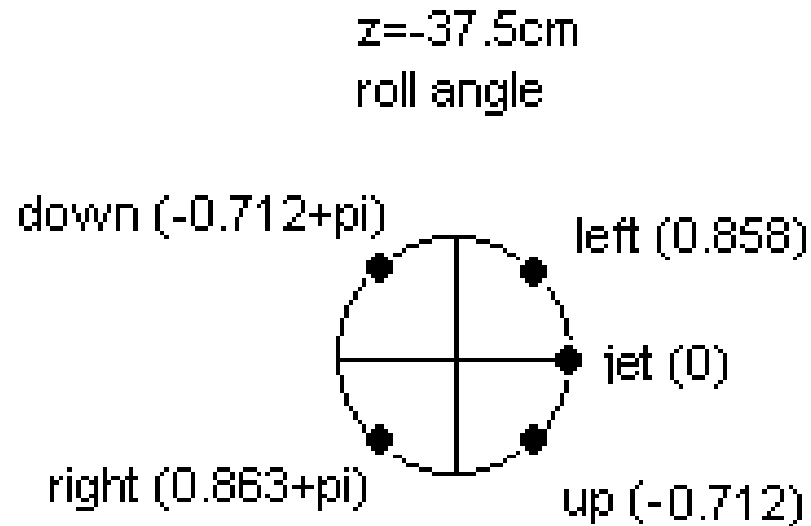

The Required Position of Beam to Jet at $z=-75\text{cm}$ to Keep Same Crossing Angle and 90° Roll Angle Apart at $z=-37.5\text{cm}$

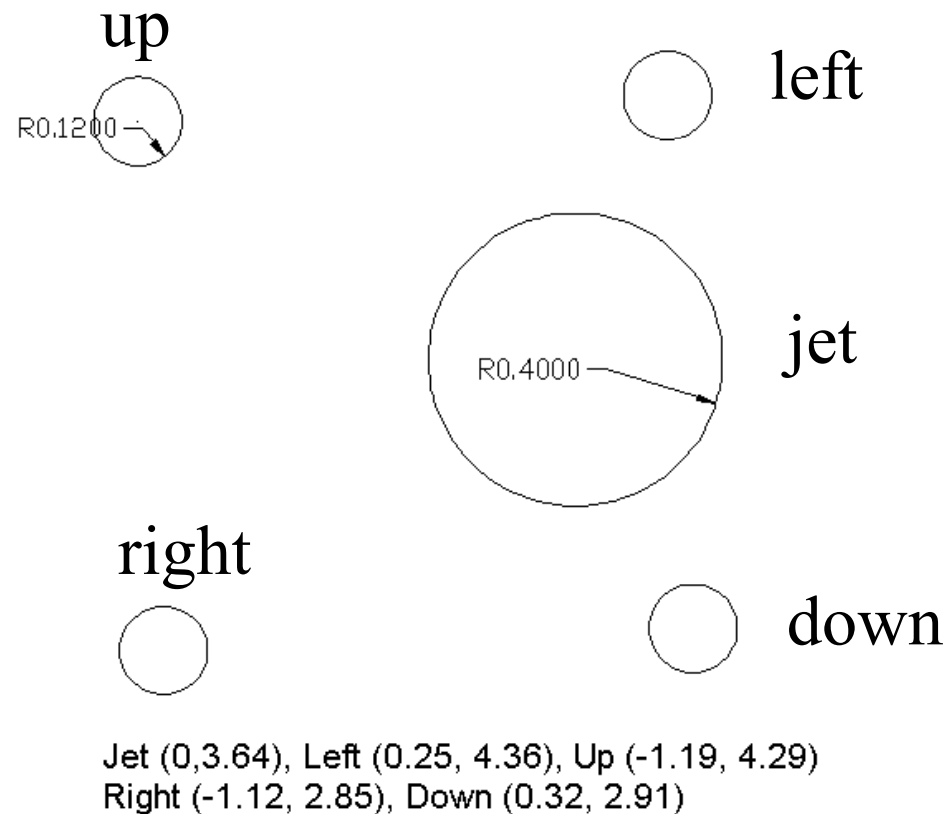

The Required Position of Beam to Jet at $z=-75\text{cm}$ to Keep Same Crossing Angle and 24° Roll Angle Apart at $z=-37.5\text{cm}$

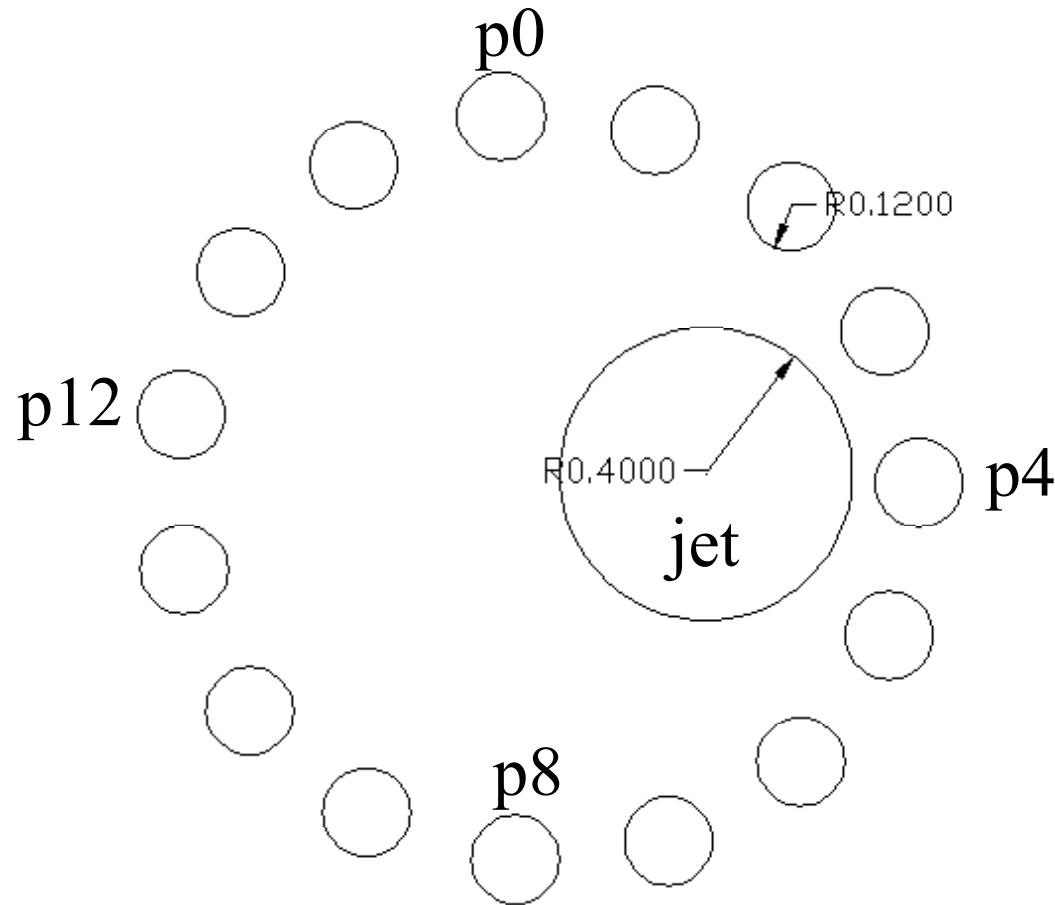

N0.	x0 (cm)	y0 (cm)
p0	-0.56	4.618
p1	-0.138	4.58
p2	0.233	4.372
p3	0.488	4.031
p4	0.583	3.617
p5	0.501	3.2
p6	0.259	2.854
p7	-0.103	2.638
p8	-0.521	2.588
p9	-0.928	2.716
p10	-1.248	2.994
p11	-1.427	3.379
p12	-1.436	3.803
p13	-1.273	4.192
p14	-0.963	4.484

Same Crossing Angle and 24° roll angle apart at $z=-37.5\text{cm}$

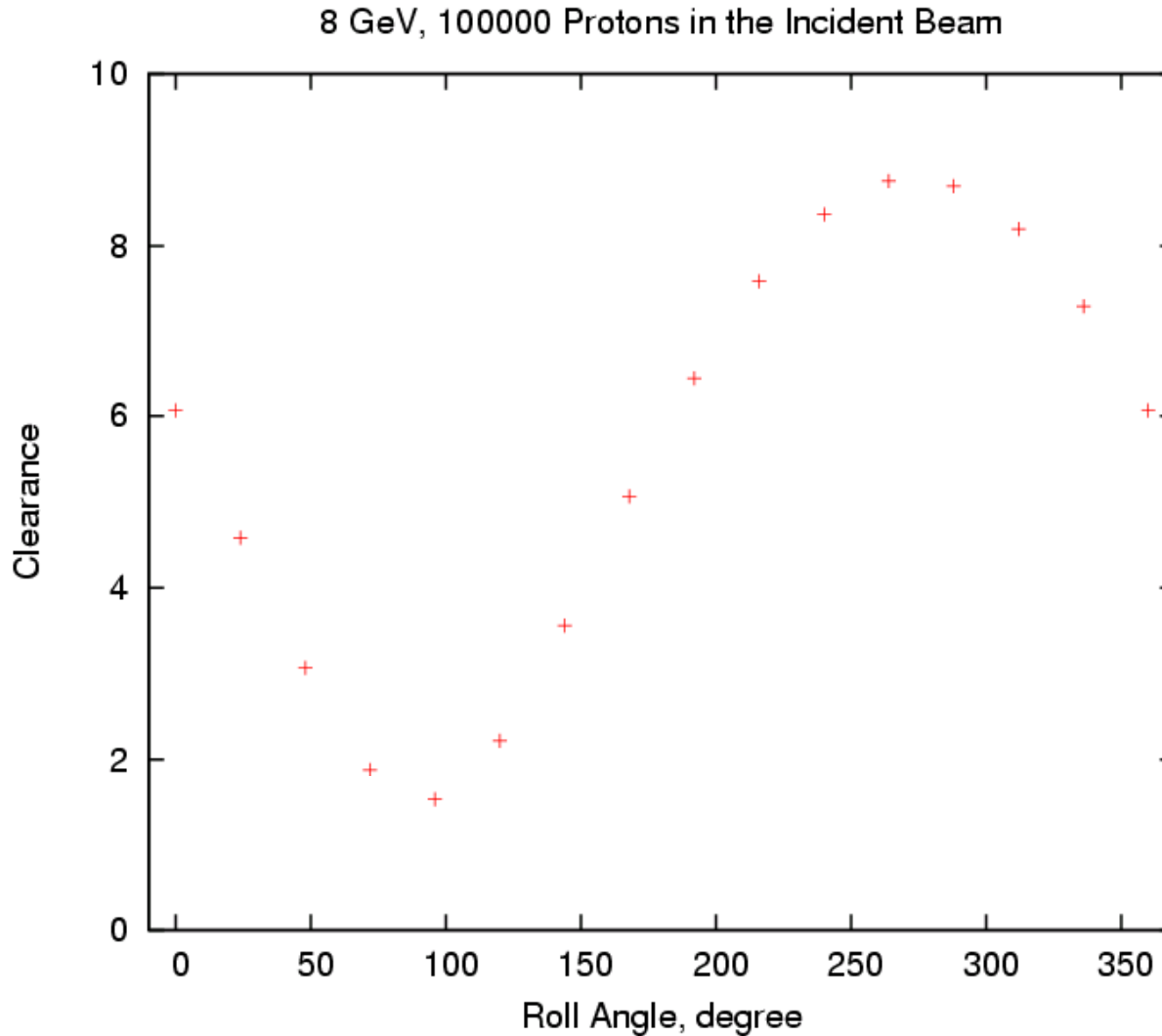

Same Crossing Angle and 24° roll angle apart at $z=-37.5\text{cm}$

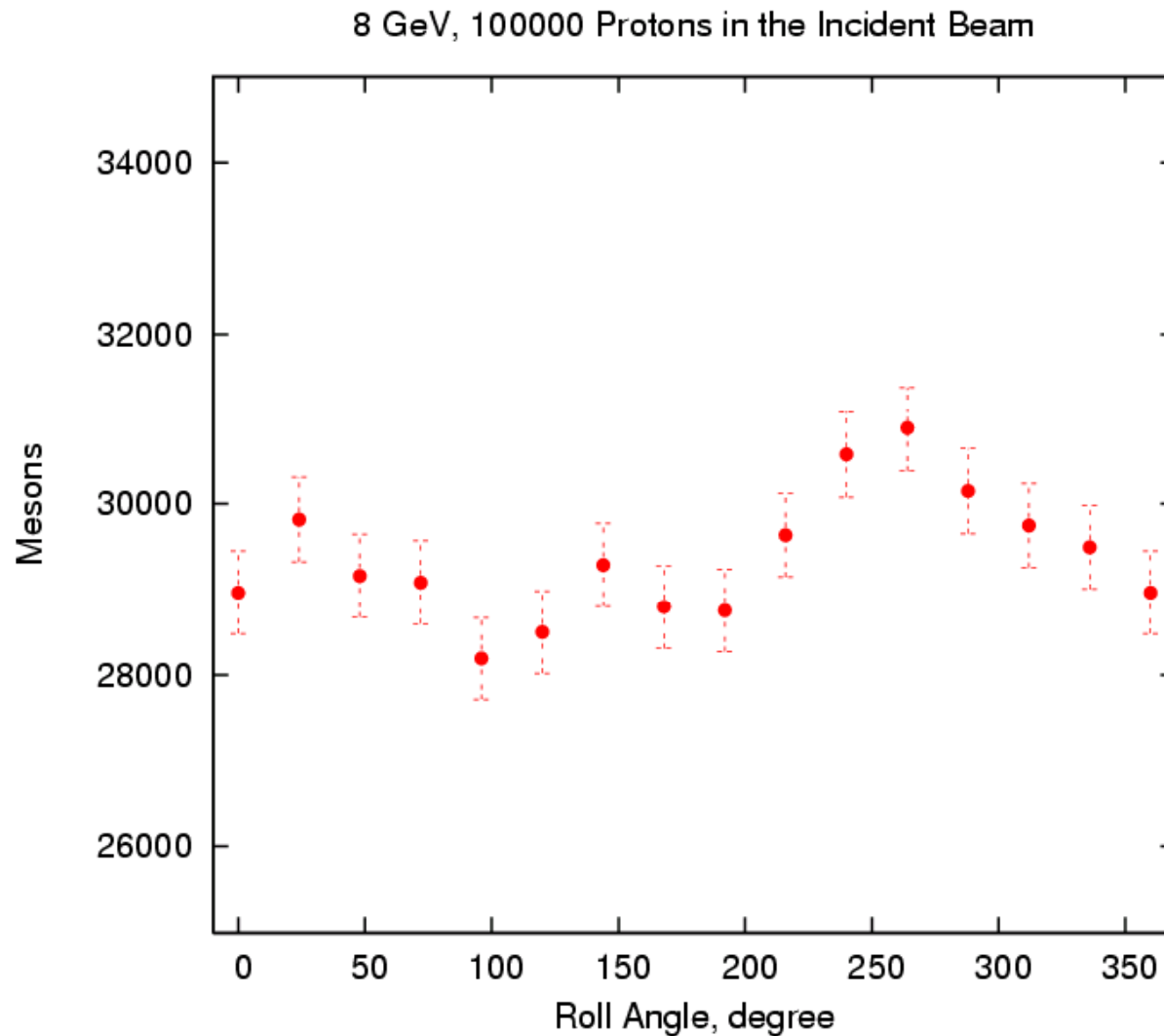

Same Crossing Angle and 90° Roll Angle Apart at z=-75cm

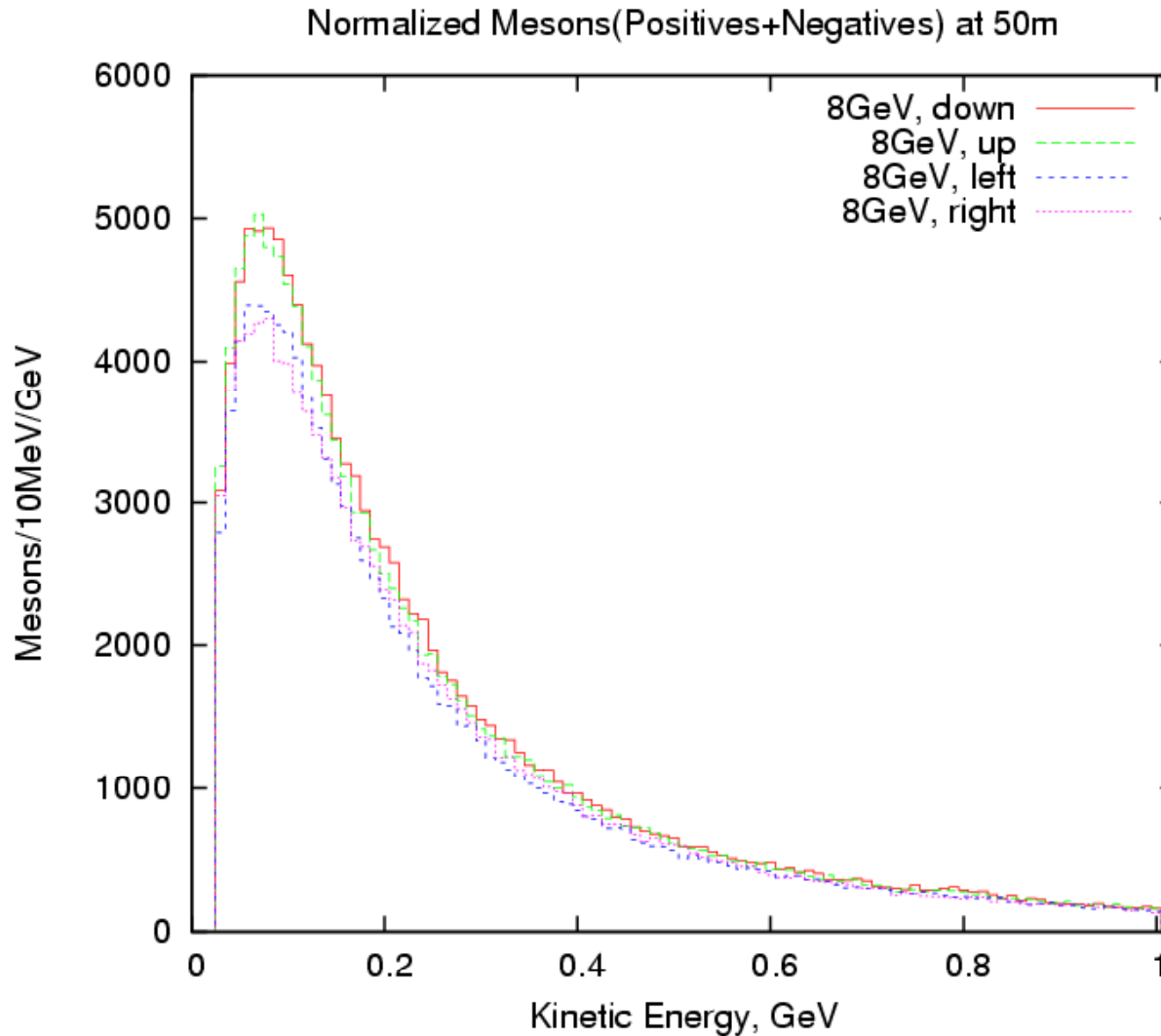

Same Crossing Angle and 90° Roll Angle Apart at $z=-37.5\text{cm}$

