



MERIT Safety Review Meeting Cryogenics

CERN

Feb. 3, 2006

Friedrich Haug

CERN

Cryogenics for Experiments

Accelerator Technology Department



Points

- Magnet
- Operation, Cooling, Safety Requirements
- System Design, Layout
- Flow Scheme, Functionality
- Safety Aspects

1. MAGNET

Features

- 15 Tesla pulsed Magnet
- 3 layer copper winding
- housed in cryostat
- 3 cryogenic connections

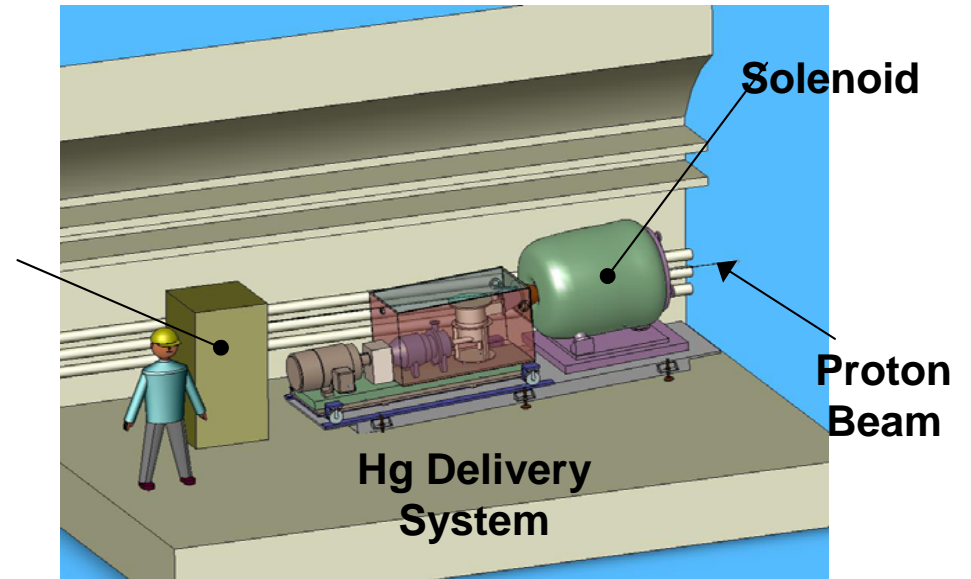

Lay-out of experiment at TT2a

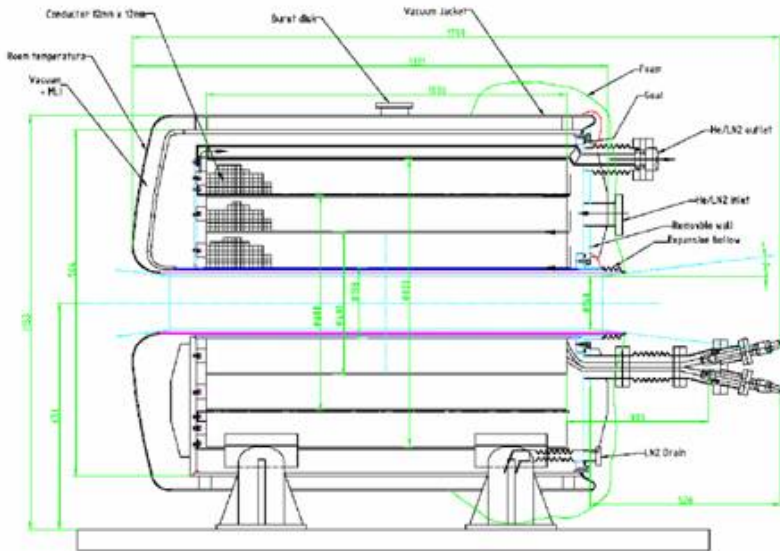

Cross section of magnet and cryostat

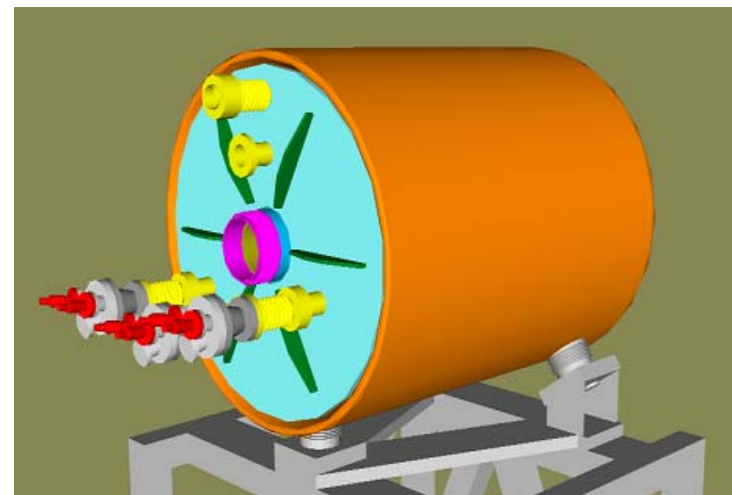

Magnet cryostat

Magnet Operation (Pulse)

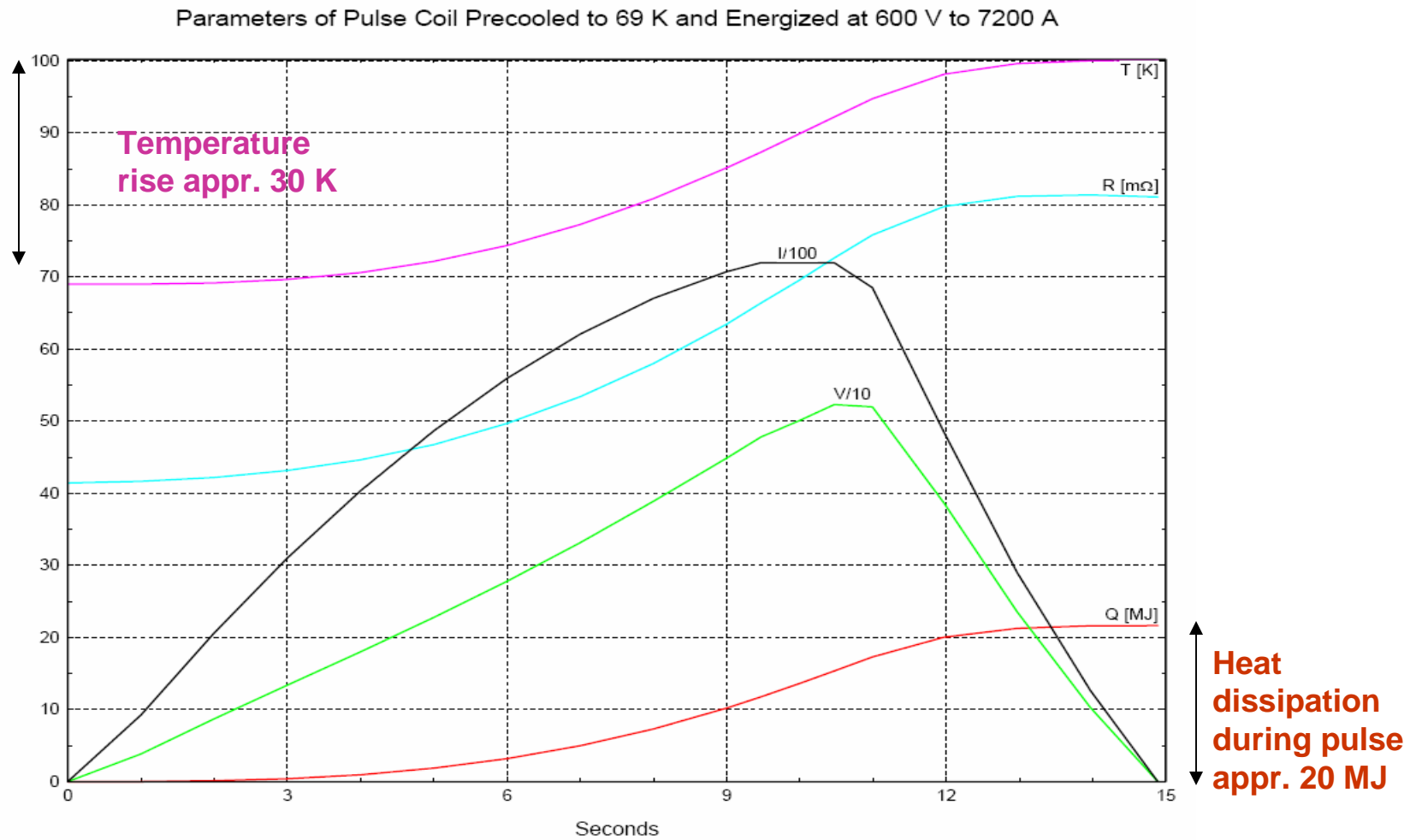

Bob Weggel's 10-14 analysis of the LN2 magnet operation



2. Operation, Cooling, Safety Requirements

- **Magnet operating temperature 80 K**
- **Cooling agent LN2 (liquid only at approx. 77 to 80 K)**
- **After pulse heating up by appr. 30 K**
- **Desired cycle time between pulses approx. 30 minutes**
- **Empty magnet cryostat prior to heating up by pulse in order to minimize pressure rise due to rapid boiling of liquid nitrogen**
- **RISK of ACTIVATION of NITROGEN during « shot »**
 - ➡ **Minimize risk of blowing out of liquid nitrogen or gas to atmosphere in tunnel by appropriate design of the cryogenic system.**

3. System Design

Layout of equipment at TT2(A) area

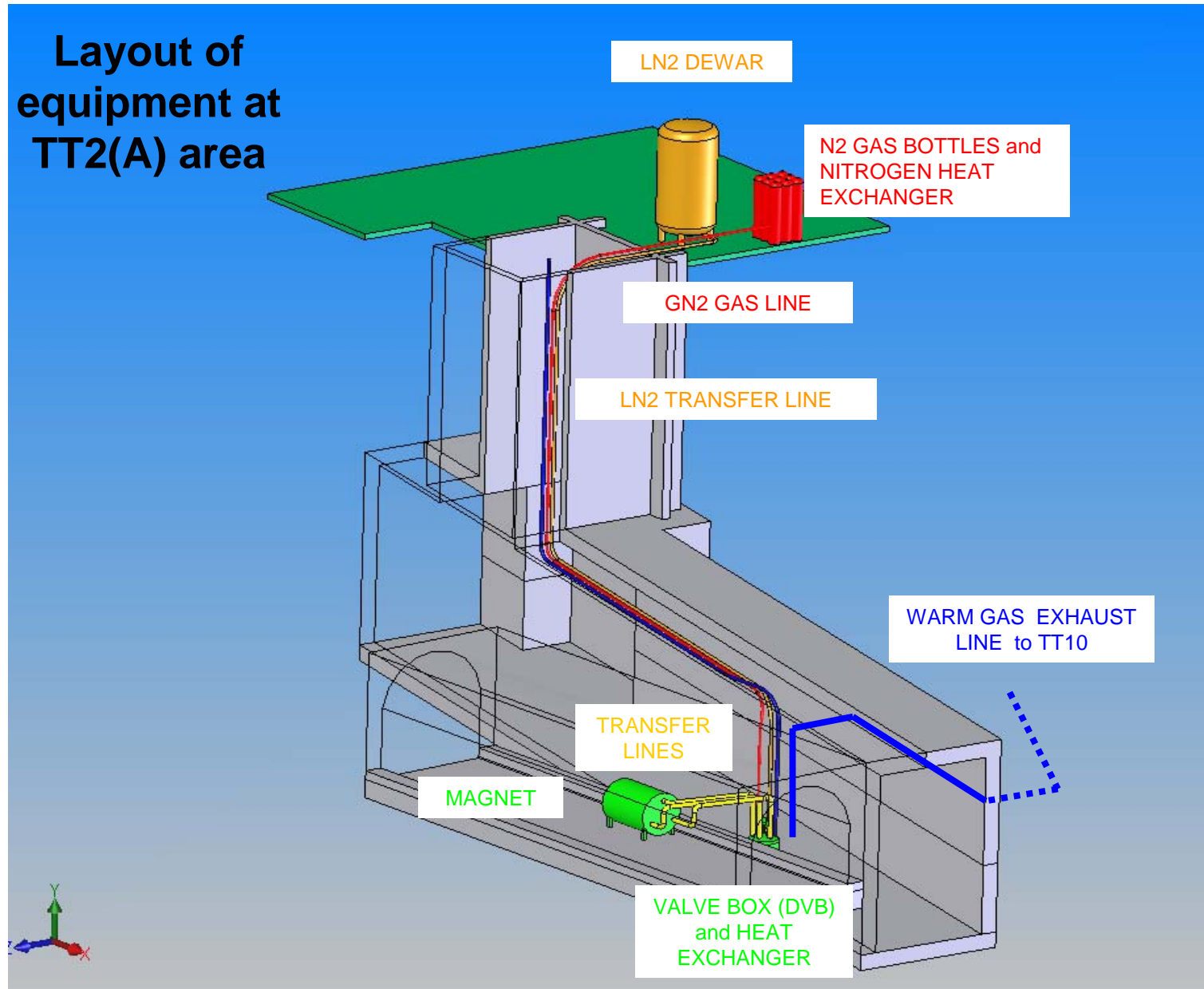

Layout Details (principle only)

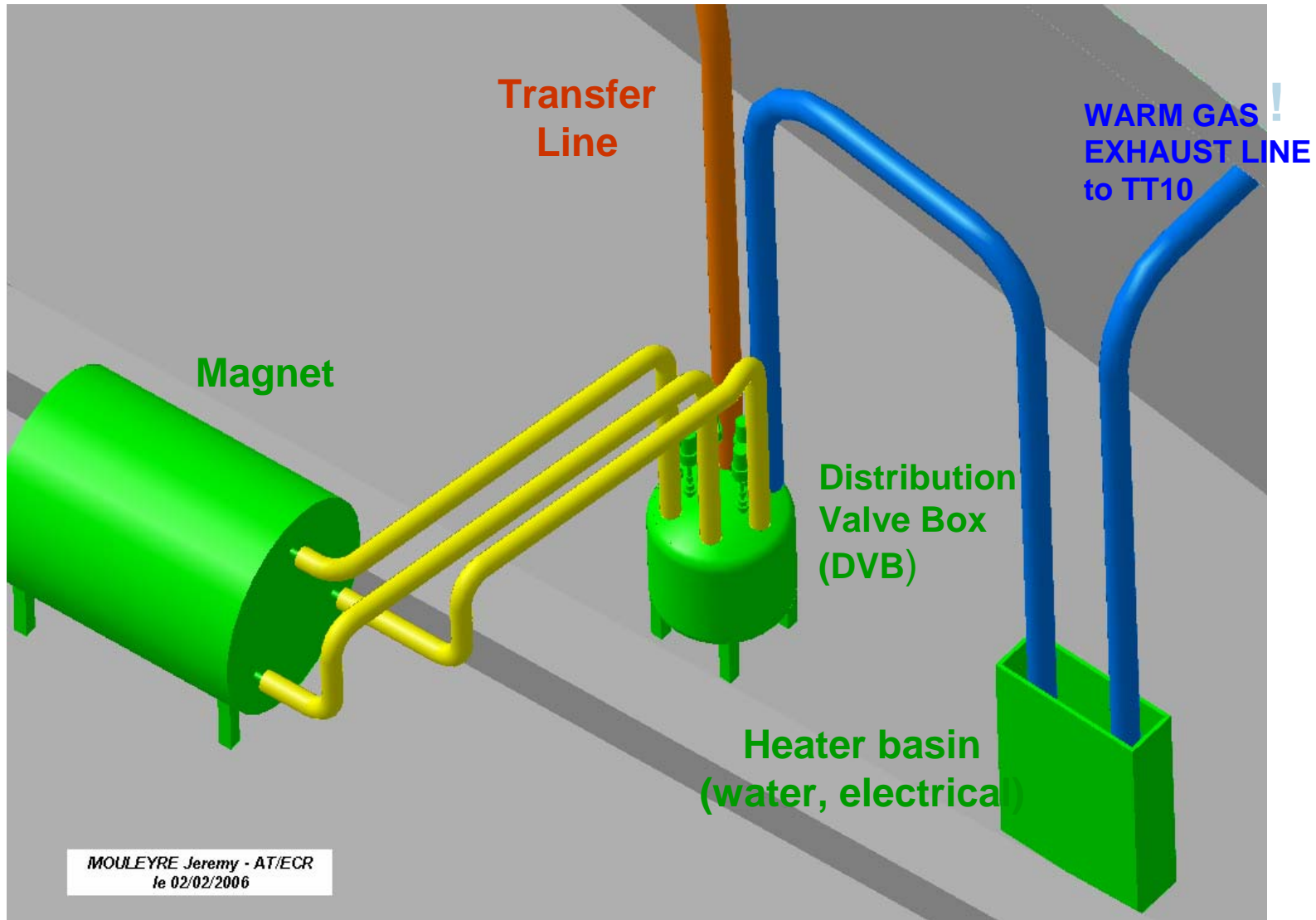



Equipment

- LN2 Dewar
- Pressurisation System (LN2 Heater, N2 Gas Bottles)
- (Main) Transfer Line
- DVB Valve Box
- Transfer Lines to Magnet
- N2 Heater for Exhaust Gas
- Exhaust Pipe
- Instrumentation
- Process Control System
- Safety Equipment

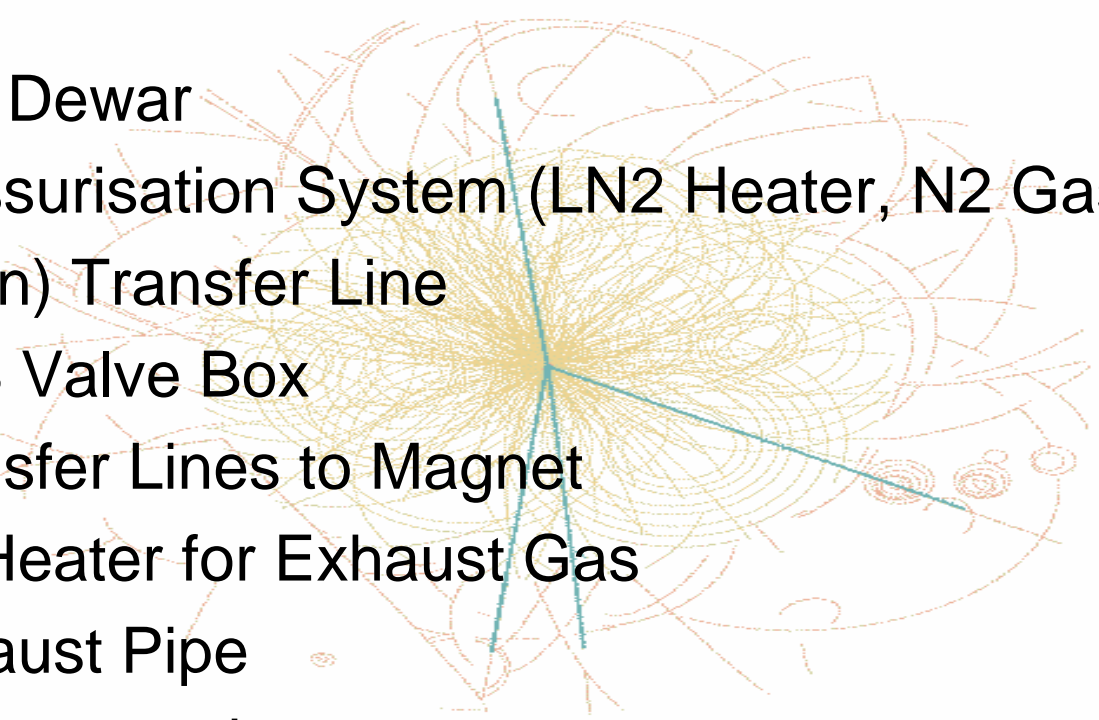

FLOW SCHEME, FUNCTIONALITY

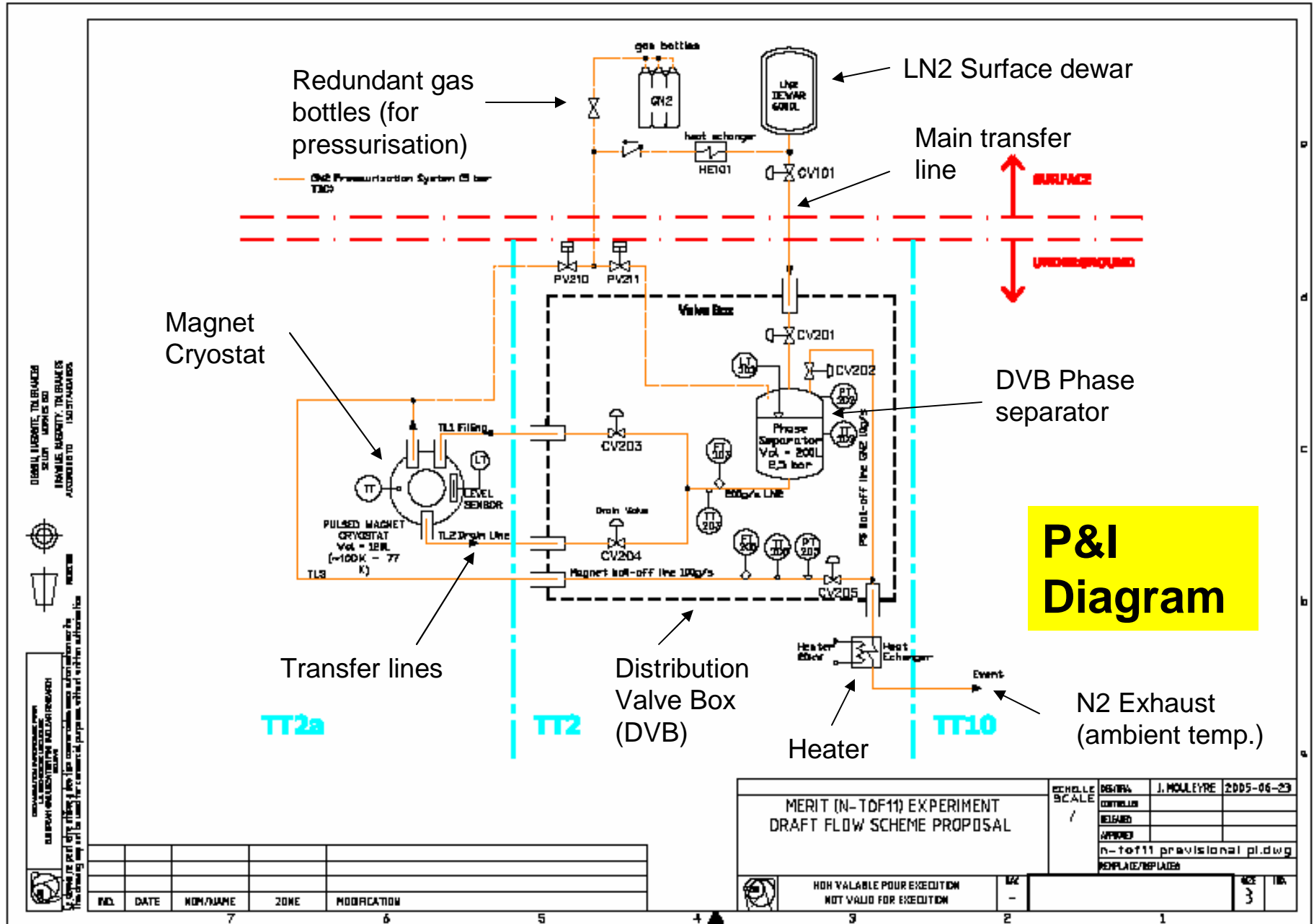



Functionality (simplified description)

Phase A (Initial cool down of magnet)

A1. Magnet pre-Cooling 300K to 77 K

A2. Magnet cryostat fill up with LN2

Phase B (Normal baseline operation)

B1. Magnet at 77 K, immersed in LN2

B2. Empty magnet by pressurisation. Liquid is pushed out to phase separator in DVB (quantity >100 l)

B3. Magnet ramp-up (Pulse)

B4. Re-cooling (stored LN2 quantity in DVB phase separator + LN2 surplus supplied from surface dewar)

B5. Fill cryostat → go to B1



Features of the Cryogenic System (Safety)

Cycle Time

- Re-cooling of magnet and filling of cryostat 20 min
- Emptying of magnet cryostat 10 min
- Magnet shot ~ 3 min
- total time between shots ~30 min

Fluid flow 100 g/s during re-cooling, 200 g/s during emptying

Blow out of LN2 in intermediate storage vessel at DVB

- Permits to minimize N2 quantity during shot (no pressure excursion)

All warm cold gas collected, heated up to ambient and transferred to TT10



One-way flow of nitrogen only !! from top dewar down to TT10. No escape lane ...

GN2 Exhaust

For reasons of potential activation all exhaust gas is routed to TT10 after having been heated to ambient temperature

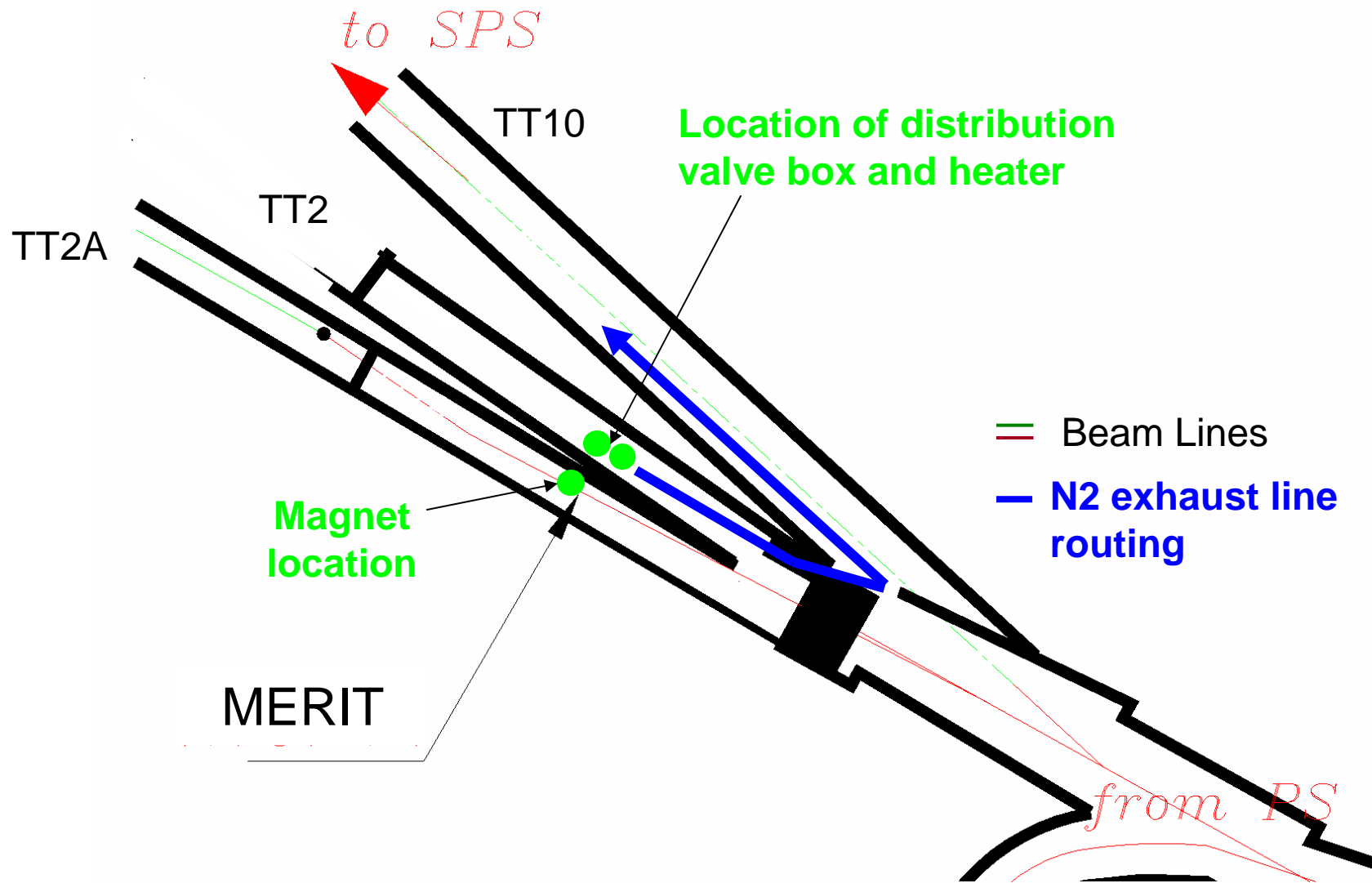

GN2 Exhaust (detailed routing)

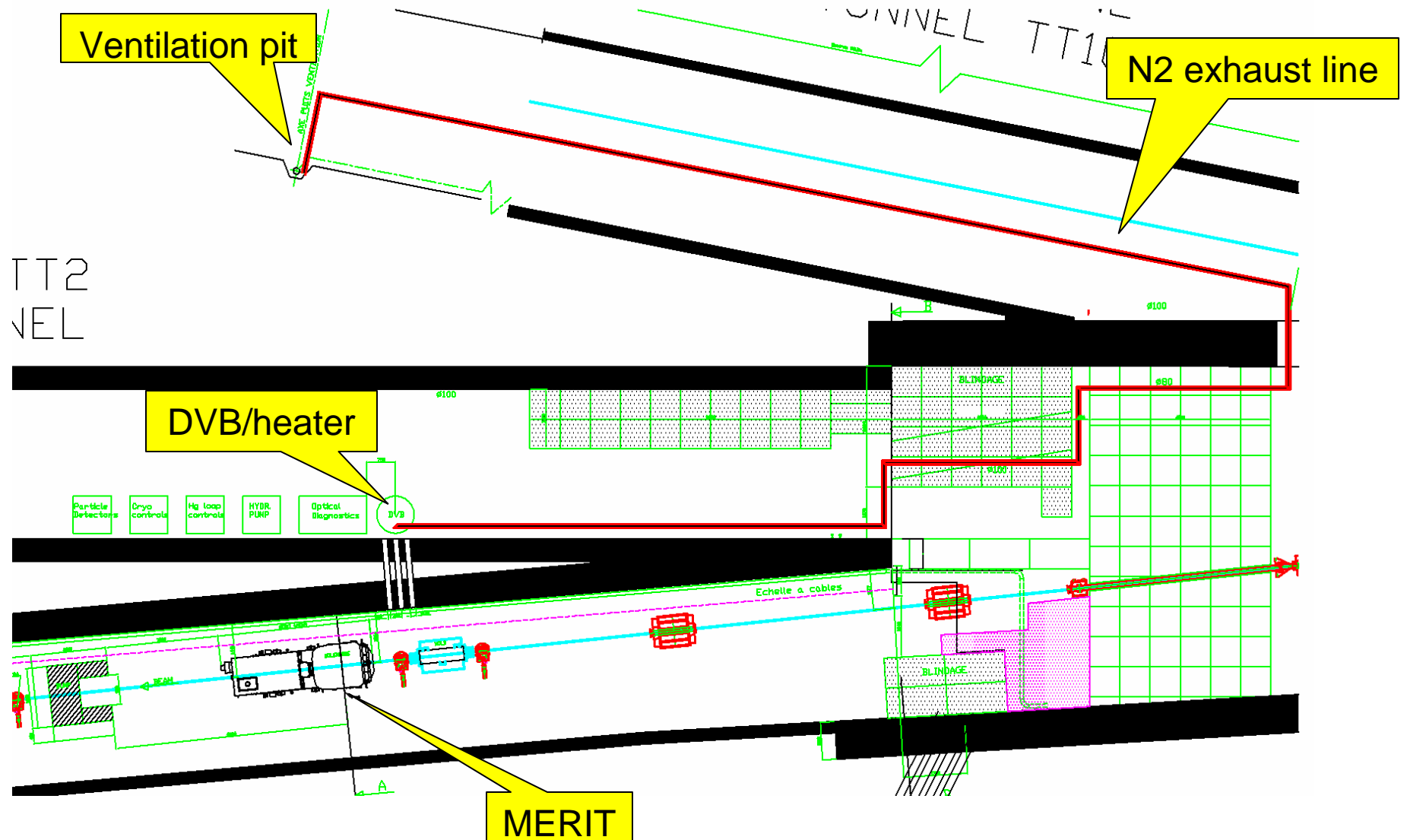



Systems Control

The Cryogenic system will be fully automated using CERN Standard for Slow Controls based on

- A) Schneider PLC and
- B) PVSS supervision.

- The PLC will be installed locally at TT2 next to the DVB
- The remote Supervision station connects via Ethernet
- Operation and supervision is done remotely
- Normally no access to underground area required during experiments



Automation and remote supervisions adds to safety for personnel

Locations (final) + Surface Test Areas + Control Room

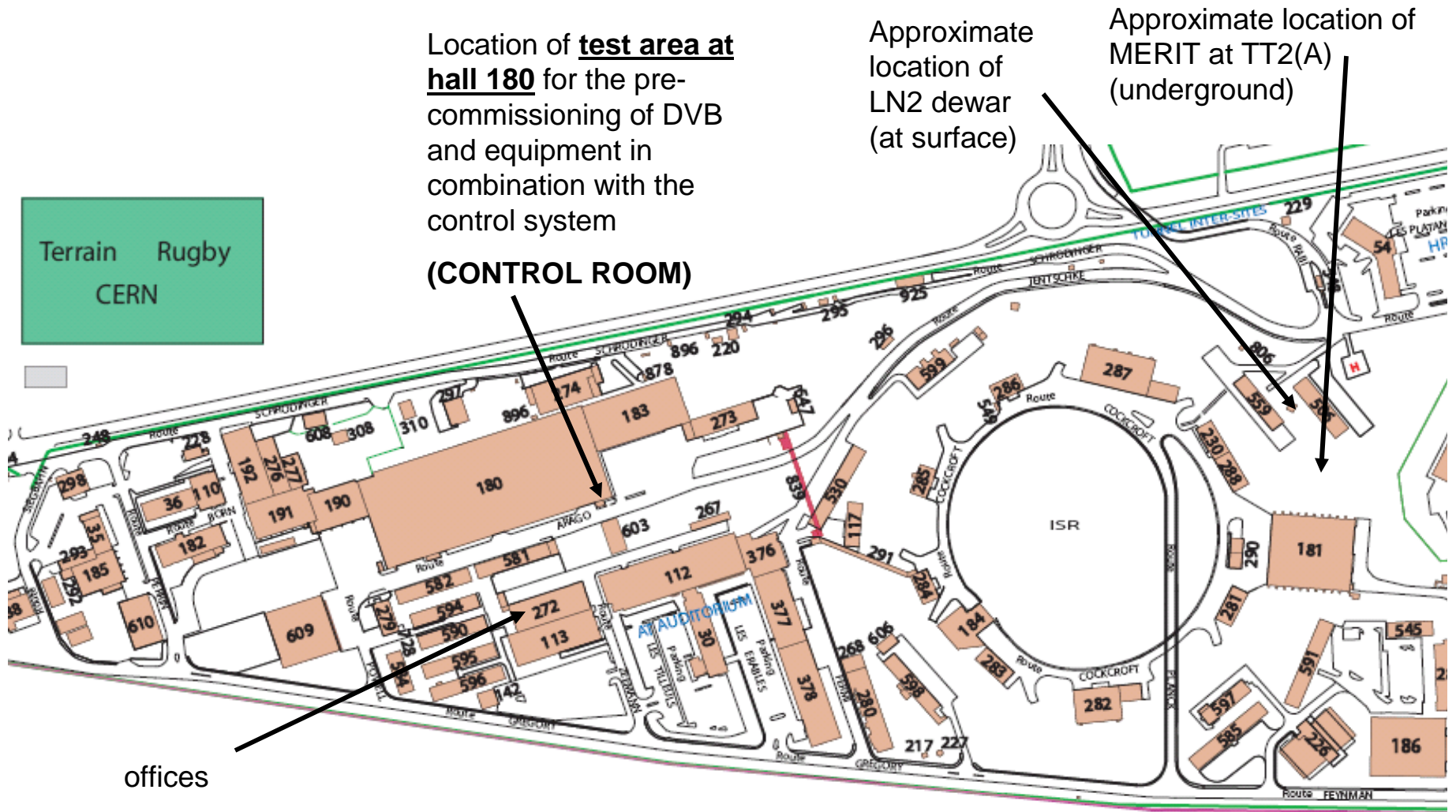

Layout of CERN Meyrin (western part) with MERIT locations

On Surface Commissioning

Prior to installation at the final point the cryogenic system will be tested and commissioned on surface:

- Cryogenic Equipment
- Instrumentation
- Control System
- Functionality Tests
- Safety Tests

This strategy, apart from gaining valuable time for the final installation and commissioning at TT2(A), helps to detect potential weak points and adds to keep high safety standard.

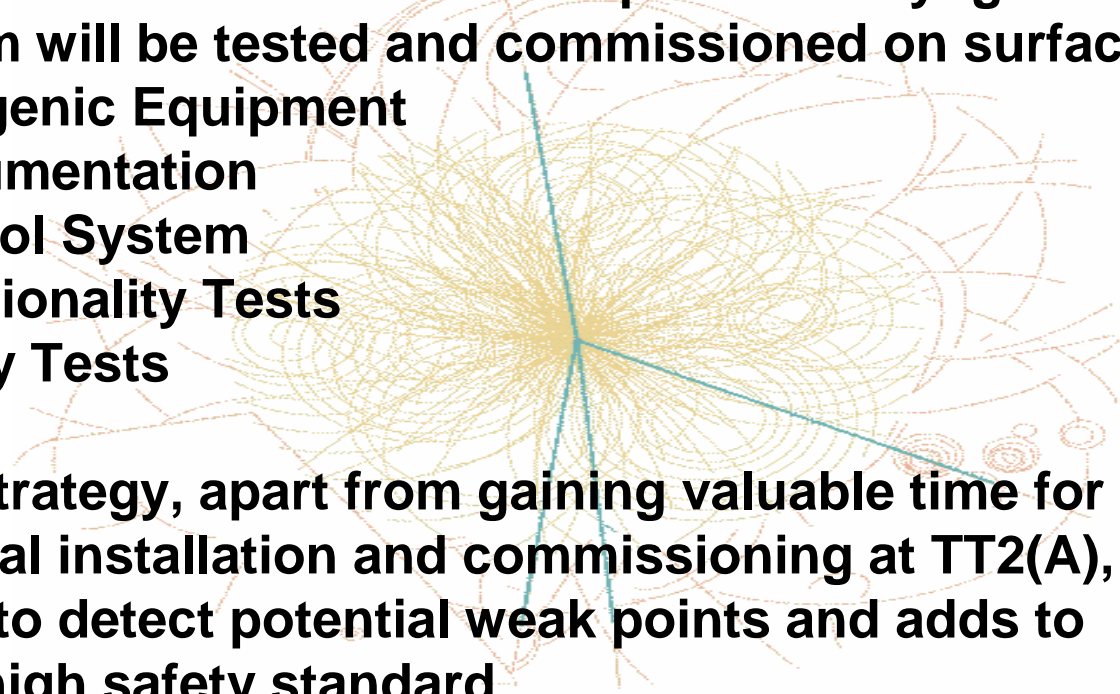

On surface test area at Hall 180



-6000 litre dewar currently used at ATLAS hall 180 test facility.

-MERIT cryogenic equipment will be installed within fenced area

-Existing control room will be available for MERIT cryogenics use.

SAFETY:

-Risk awareness.

-ODH ? (fix, portable ?)



ATLAS Liquid Argon Calorimeter

FLOW SCHEME, SAFETY ASPECTS (Passive safety)

- Location of safety valves
- Routing of nitrogen gas flow

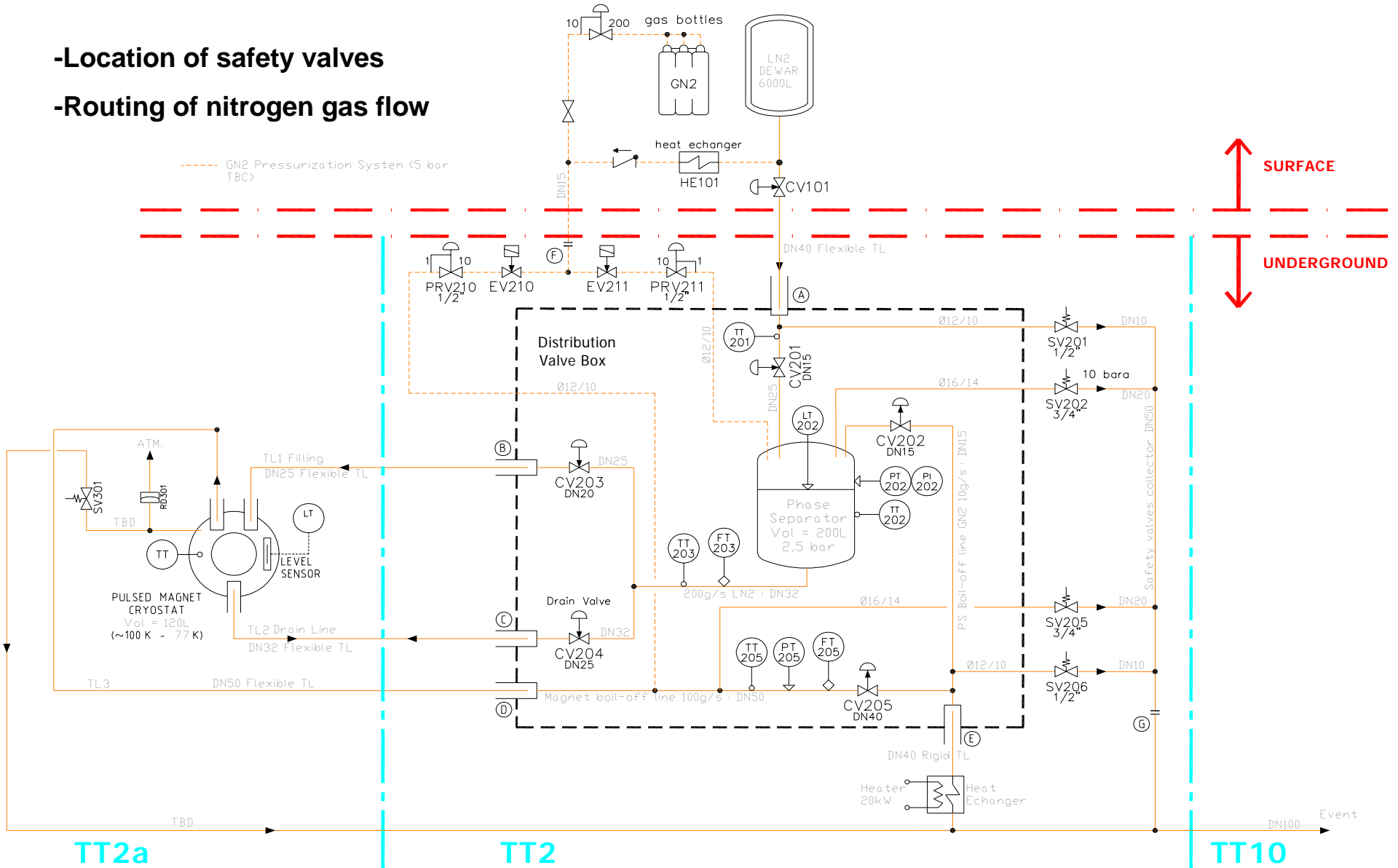

MERIT EXPERIMENT FLOW SCHEME	ECHELLE SCALE	DES/DRA	E. MATTELON
	/	CONTROLLED	
		RELEASED	
		APPROVED	

Passive Safety Devices

- All safety valves exits are connected to collector piping where all cold gas is collected and routed DIRECTLY to the exhaust line by-passing the heat exchanger.

This solution has been chosen to provide for minimum back-pressure in the cryogenic system, in particular the magnet cryostat.

-The ultimate safety device(s) is the rupture disc (not connected to the exhaust line).

Passive Safety Devices

On Magnet

-one Safety Valve

-one Rupture Disc

(on different lines?)

On DVB

-Safety Valves

-Rupture Disc on large volume ?

Staging of Safety Valves and Rupture Discs

(values proposed are approximate only, final staging after on-surface commissioning)

RD 301	15 bar	SV 301	12 bar
SV 205	8 bar		

SV 201	15 bar	SV 202	10 bar
SV 206	10 bar		

Risk Assessment at TT2(A)

Potential hazard to people working underground (TT2A and TT2) exist in case of accidental spills of LN₂ and loss of GN₂

Potential Risks for personnel are

-Asphyxiation, -Cold Burns, -Hypothermia !

“Cryogenic Systems Built-in” Safety Measures :

- 1) Adequate design by
 - Choice of material and quality assurance during construction
 - Reliable interconnection bayonets
 - Choice of instrumentation
- 2) Minimize required access of personnel by
 - a) Remote supervision system
 - b) Fully automated process control
- 3) Automation permits to minimize risk of hazardous situations like pressure build-up in vessels by active control of the parameters
- 4) Safety valves and rupture discs are used as ultimate passive safety feature to protect equipment and personnel
- 5) Interlocks with the magnet power control system

Safety (continuation)

- Risk assessment in collaboration with the Safety Commission
- Technical Solution for ODH Detection with Technical Service Dep.
- ODH must be an automated detection system with links to TCR (Technical Control Room) and SCR (Safety Control Room) via “CSAM” (CERN Safety Alarm Monitoring)
- Procedures
 - Access control
 - Safety training training of personnel working in underground areas in the neighborhood of cryogenes (specific CERN safety courses required)



Safety Systems (example ATLAS)

Collective Safety Systems

- Passive safety measures (discharge)
- ODH detection and warning
- Emergency ventilation and extraction
- «Red phones» to Safety control room
- Personnel rescue by fire brigade

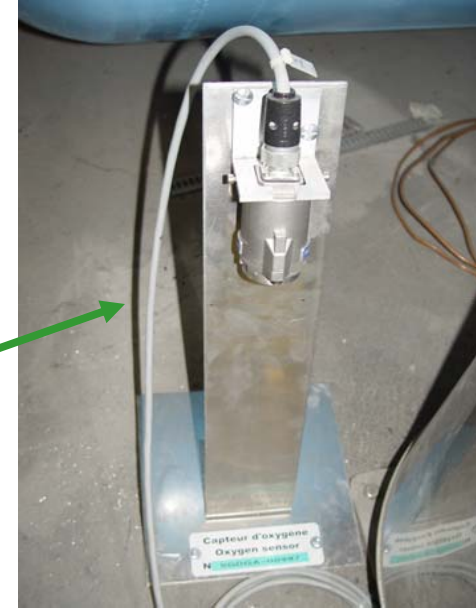

Individual Safety Systems

- Mobile telephone,
- Portable ODH detector
- Breathing apparatus ?



Radiation

We have studied the possibility to use radiation hard instrumentation in case of necessity.

SEE or ionisation radiation can have a strong impact to the proper functioning of equipment which may be upset having consequences for safe operation.

Such instrumentation has been developed for the LHC collider and the experiments environment.

Recent studies have shown that the radiation level, fortunately, is very low.

Therefore standard industrial instrumentation will be used for MERIT

Provisional Planning (simplified)

Hall 180

- Commissioning
- Surface Tests

Sept. 2006

Oct. 2006

LN2 !

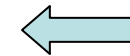
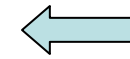

TT2A area

- Various infrastructure preparation
(including safety equipment in case required)
- Magnet delivery
- Transfer cryogenics from hall 180

until Sept. 2006

Nov. 2006

Nov. 2006

- Commissioning with provisional cold tests
- Final operation

Dec. 2006

Apr. 2007

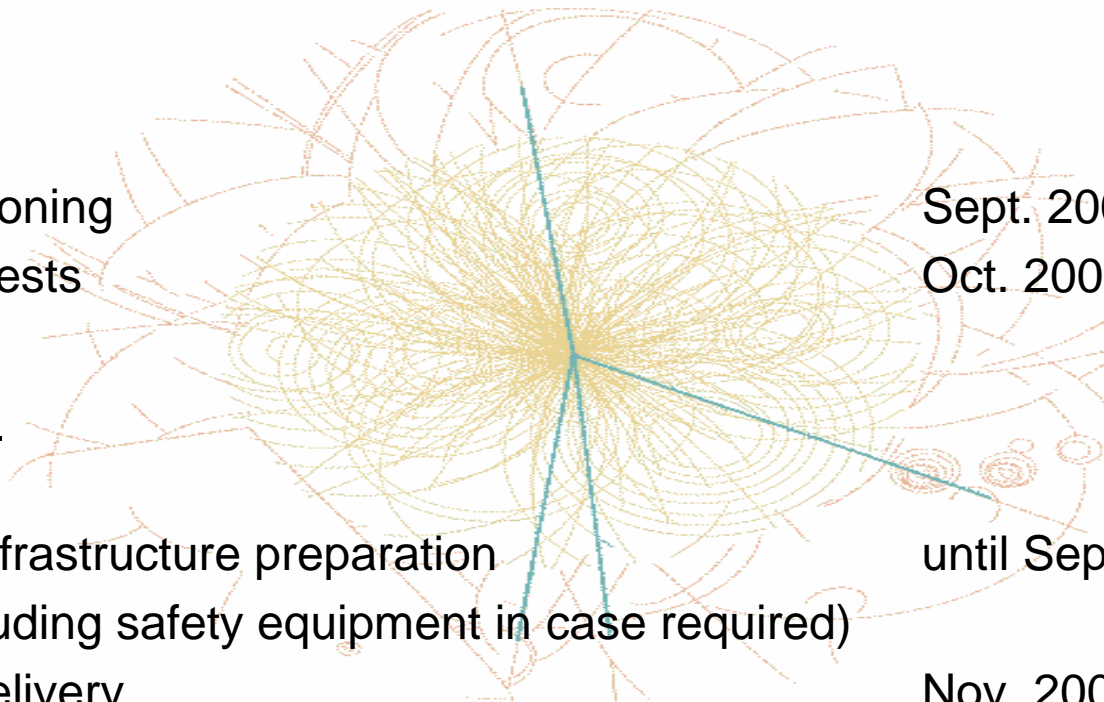
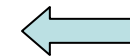
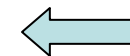



**Thank you for your
attention!**

Please question !!!