

IEA W-GIFT-6

SMALL SPECIMEN TEST TECHNIQUE UNDER IFMIF/EVEDA PROJECT OF BA

FOR FATIGUE AND FRACTURE TOUGHNESS

JAEA EIICHI WAKAI, ET AL.,

26 SEPTEMBER 2012, LIEGE

Background and Required Conditions of Fatigue Tests

- On a design of a blanket for a fusion reactor, an elastic-plastic analysis of the structure will be performed since huge amount of heat must be removed by a pressurized coolant.
- In addition, the pressure varies and the cyclic deformation occurs.
- The design fatigue life of the blanket will be around 1×10^4 cycles and it assumes the plastic strain component.
- Therefore, the design will be carried out under low cycle fatigue condition.

Small Fatigue Specimen

■ Test section

- ✓ **Round-bar** type with test section **diameter of 1 mm** and gauge length of 3.4 mm
- *Round-bar type with test section diameter of 3 mm and gauge length of 7.5 mm in EU. → Probably too large*
- *Hourglass type with minimum diameter of 1.25 mm in Japan. → Effect of stress concentration*

■ End connection

- ✓ **Modified button head** type with flat sheet shape
- *Thread type has been adopted in EU.*
 - *Clamping of this end-connection would be difficult if swelling and embrittlement of the specimen occurred due to the neutron irradiation.*
- *Flat sheet type, which is fastened by fixtures with pressure, has been adopted in Japan.*
 - *It would not be easy to reduce bend strain of the specimen caused by the gap between the positions of both up and down bodies of fixture.*

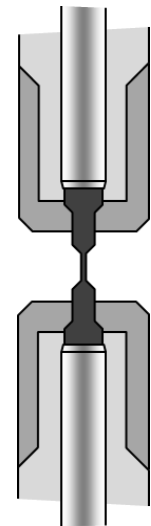
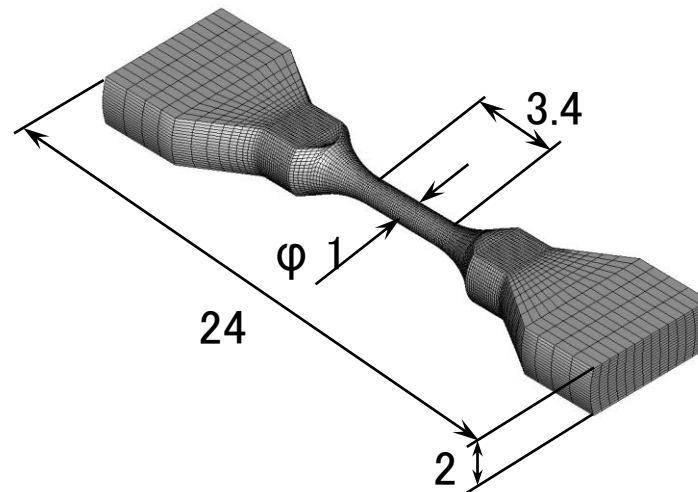

Fatigue Testing Machine for Small specimen

- ✓ Testing machine for room temperature in air and high temperature in air has been developed.
- ✓ Testing machine for high temperature in vacuum is being developed.

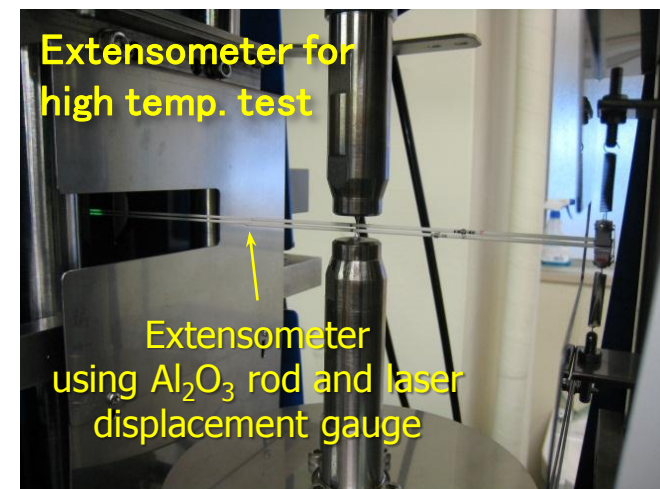
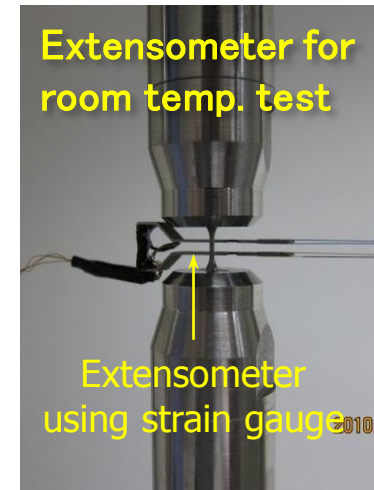
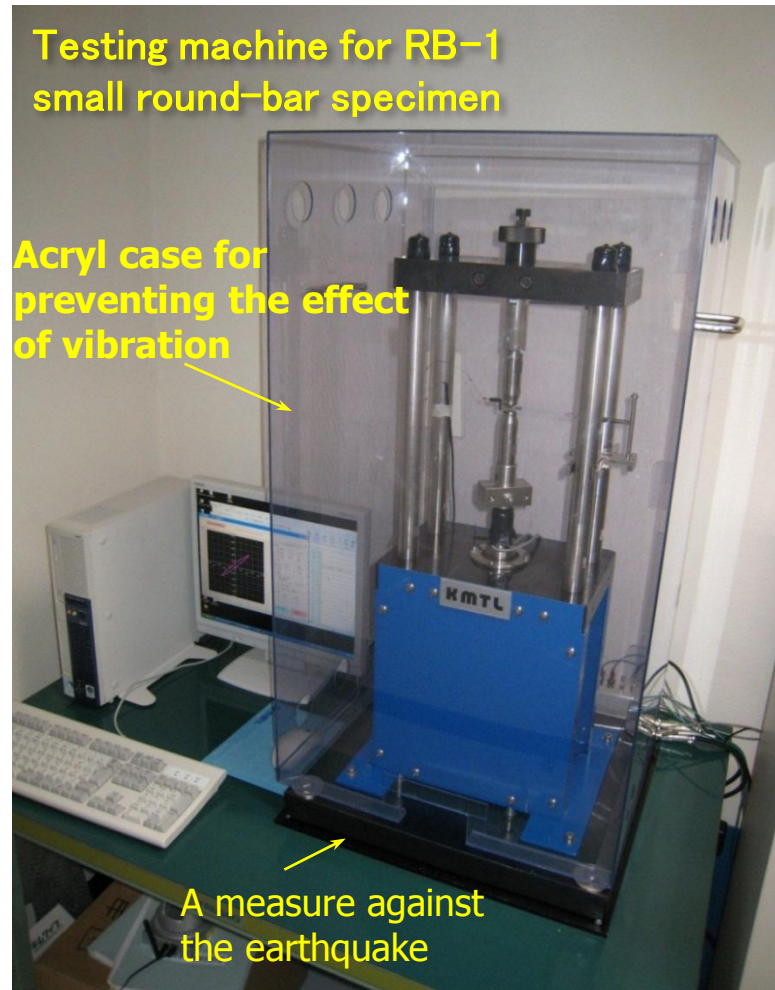

Laser Extensometer with Nano-meter Accuracy

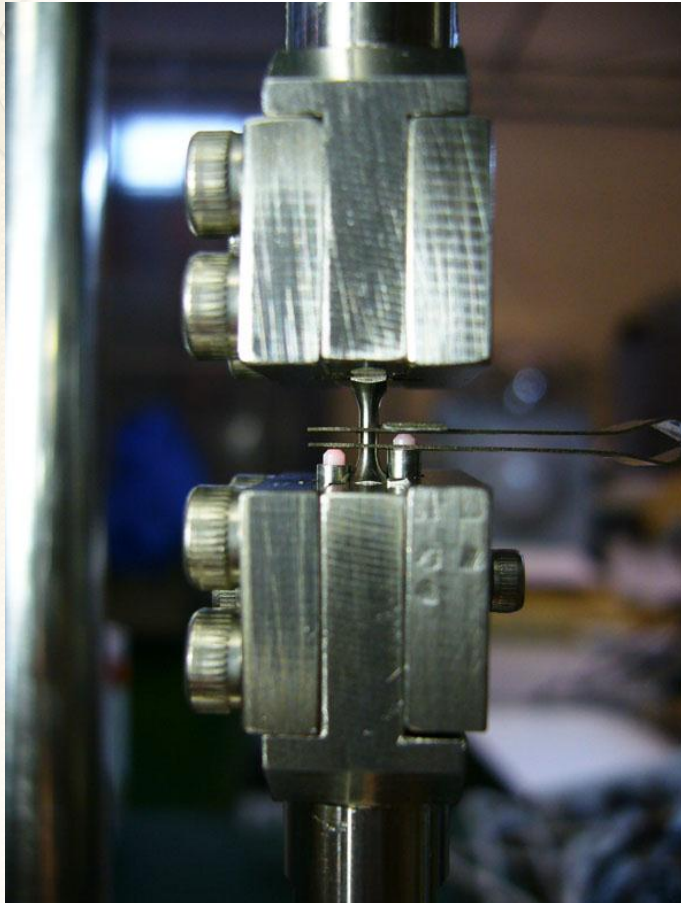

Laser micro head: 1.25 mm dia.
Cover sheath: 2.0 mm dia.

Reflecting plate
(0.2 mm thick)

Specimen
(1.1 mm dia.)

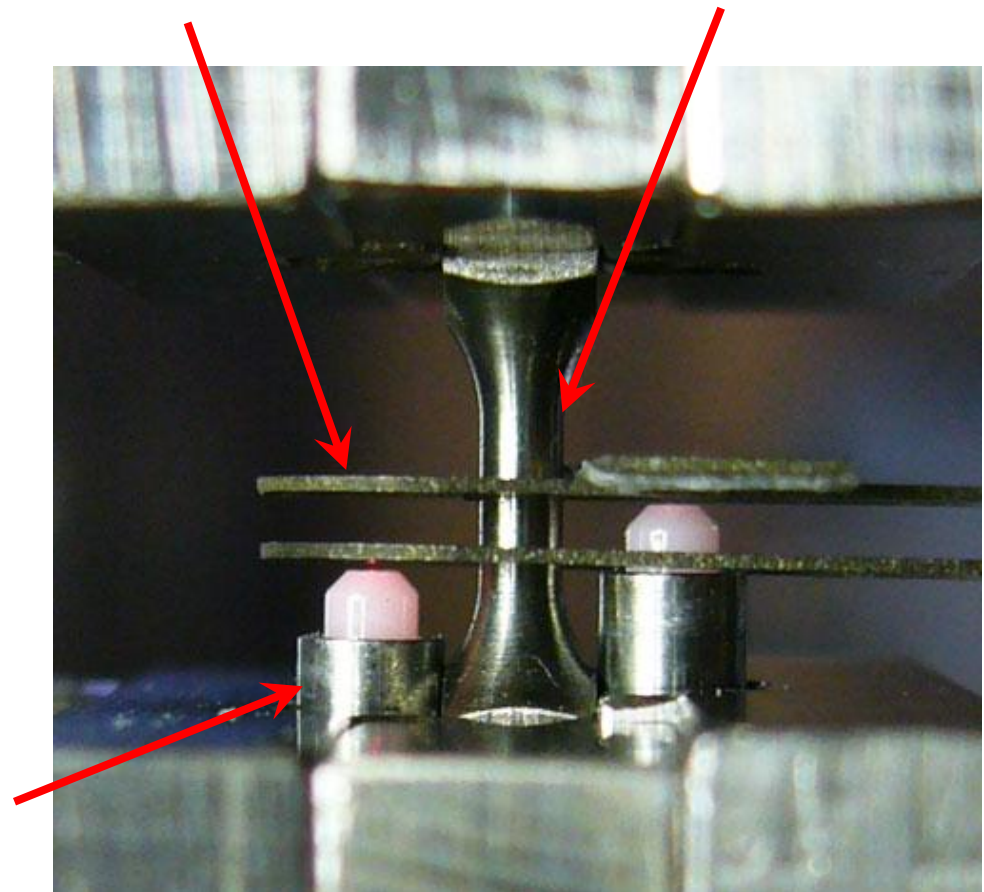

Fatigue Life of Small Fatigue Specimens

- ✓ No specimen size effect (Diameter ϕ 1–10 mm $\rightarrow \phi / d \geq 10$) in round-bar and hourglass specimens
- ✓ No specimen shape effect in round-bar specimen
- ✓ Significant shorter fatigue life at low strain range due to stress concentration in hourglass specimen
- ✓ Slight longer fatigue life at high strain range in hourglass specimen
- ✓ High resistance to buckling in hourglass specimen

F82H-IEA (Grain size : d50–100 μ m)

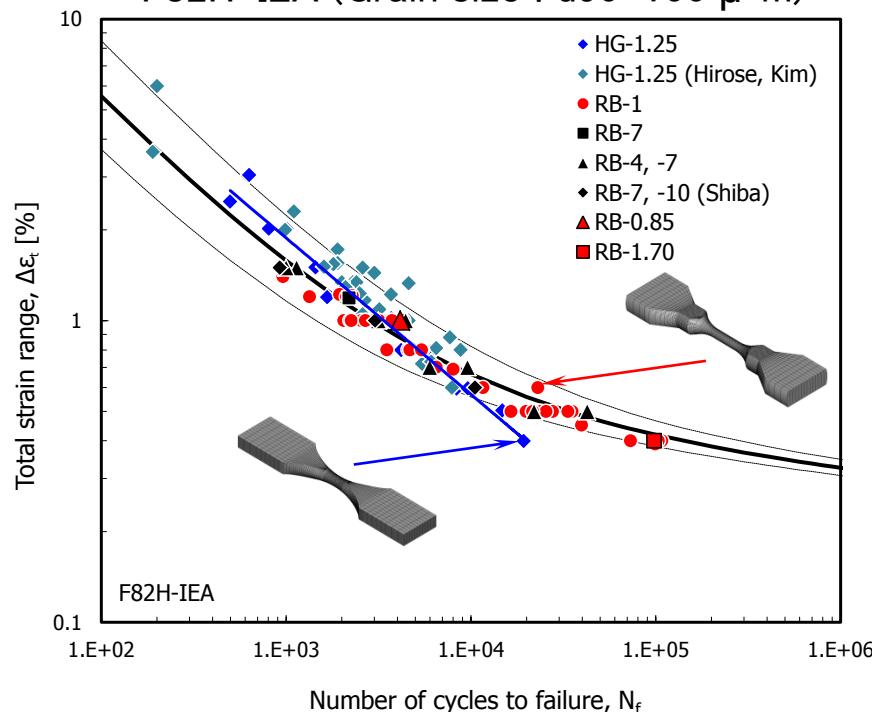

JLF-1 (Grain size : d20–50 μ m)

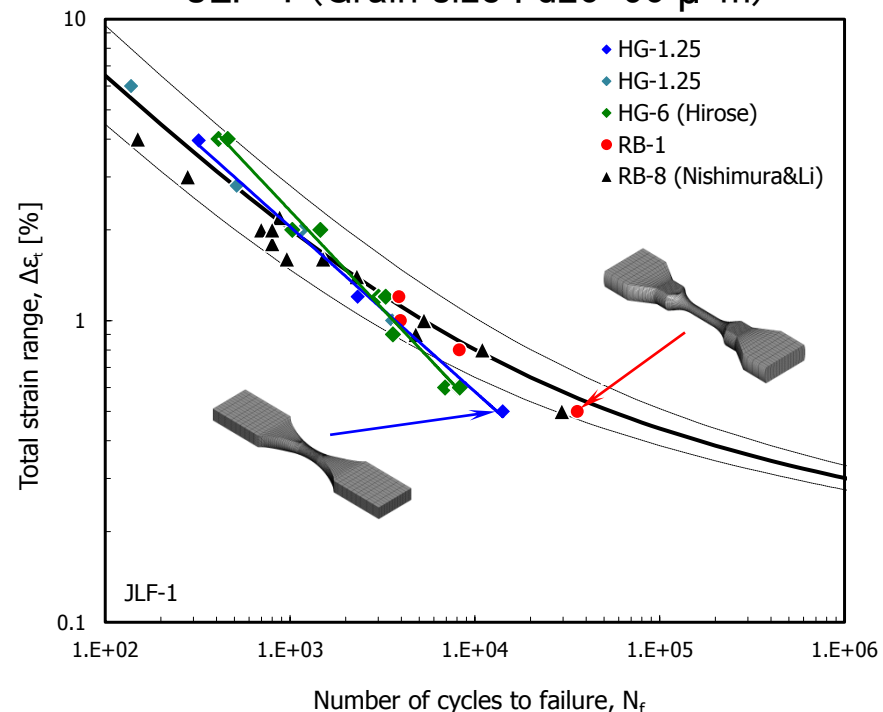

RB-x: The round-bar specimen with test section diameter of x mm

HG-y: The hourglass specimen with minimum diameter of y mm

By S. Nogami (Tohoku U.) and A. Nishimura (NIFS)

Further Analysis of Fatigue Test

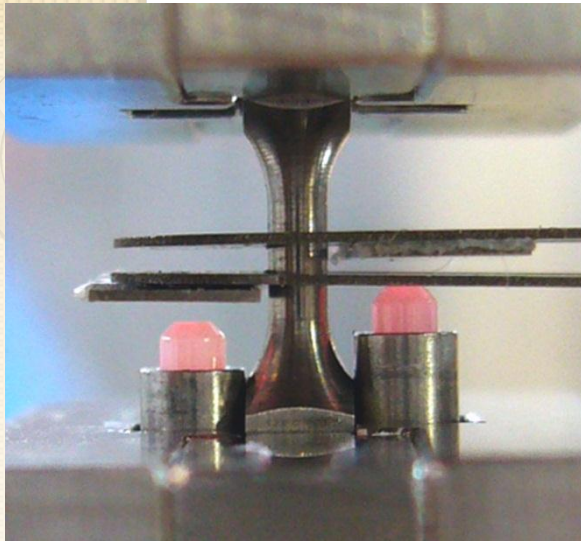

Fig. 1 Set up of specimen and laser head.

Fig. 1. The specimen has a part of a round bar with 1.1 mm diameter and 2.0 mm parallel part length. The laser displacement gage has an accuracy of 1 nm and the diameter and the total control accuracy of the test system would be considered to be an order of 10 nm. Two sets of the laser displacement gages were used. One measured change in displacement of an upper reflecting plate on a support beam and the other measured that of a lower reflecting plate. By subtracting one from the other, the axial deformation of the gage length was obtained and the deformation signal was feed backed to a controller of Piezo actuator with capacity of 150 μm . Load was measured with a load cell of ± 1 kN. Test material was JLF-1 and the test was carried out at room temperature using sine wave under 0.25 Hz. The initial gage length was determined by the distance between traces of the support beam edges. The hysteresis curves of #6 specimen are shown in Fig. 2 and the changes in stress and strain during fatigue are shown in Fig. 3. At the early stage of the fatigue, the plastic strain component is small and the peak stresses are high. However, the plastic strain becomes large and stable at less than 10% of the fatigue life (N_f). The peak stresses become gradually smaller and it is recognized that JLF-1 shows the cyclic softening during the fatigue. Since the standard fatigue specimen did not show such an increase of the plastic strain at the early stage [2], some different fatigue behavior might be exist in the fatigue test with the miniature specimen.

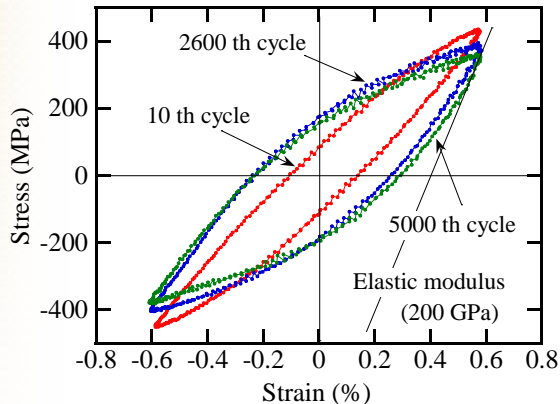

Fig. 2 Hysteresis curves of #6 specimen.

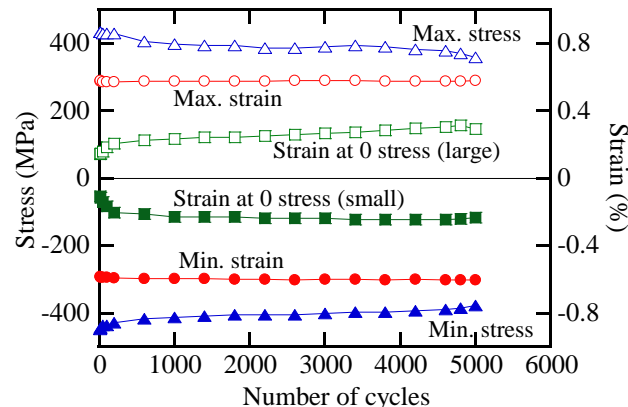

Fig. 3 Changes in stress and strain of #6 specimen.

Further Analysis of Fatigue Test

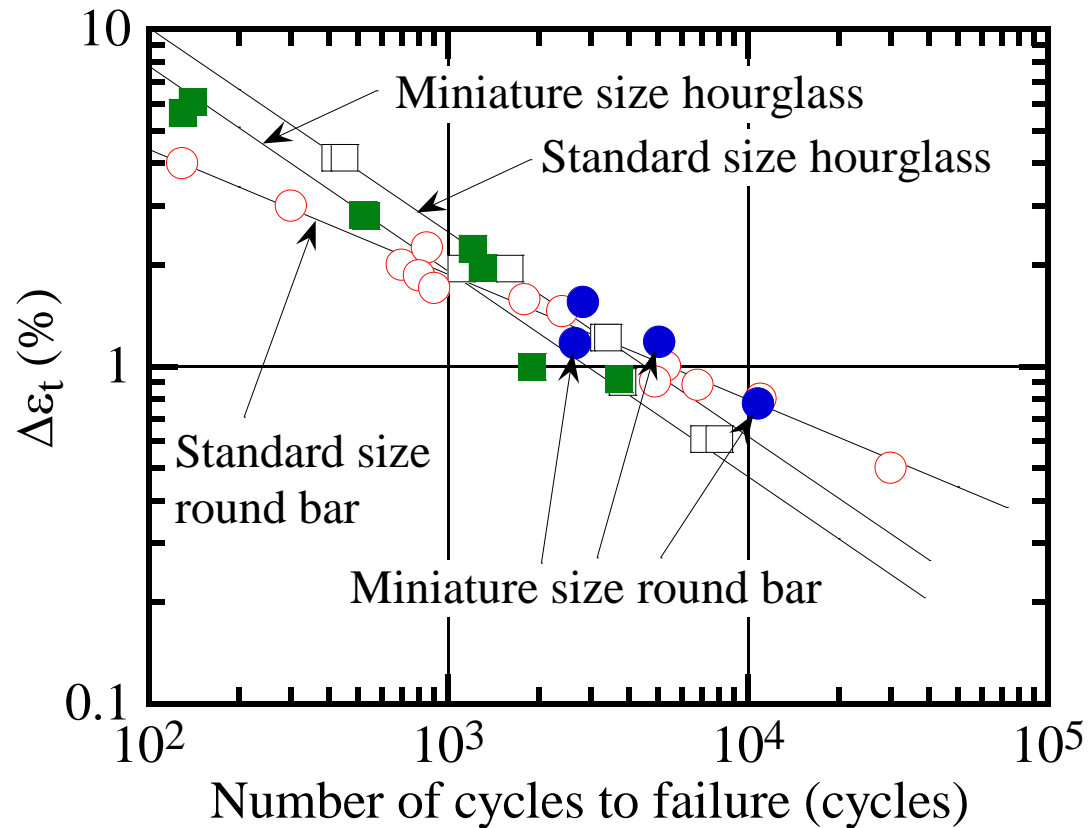

Fig. 4 Fatigue life of JLF-1.

The fatigue life data are summarized in Fig. 4. Four data sets are presented, standard and miniature round bars, and standard and miniature hourglasses. It is clear that the miniature hourglass gives shorter fatigue life than the standard hourglass. In case of a round bar, the data of the standard and the miniature specimens are plotted on the same line. From this fact, it is recognized that **the miniature round bar specimen gives the same fatigue life as the standard.**

Development of small specimen test technique on fracture toughness using the miniaturized CT and 3 Point Bending specimen

***B. J. Kim, E. Waka (JAEA),
R. Kasada, A. Kimura (Kyoto Univ.)
Y. Kurishita (Tohoku Univ.)***

Introduction (1/2)

Fusion blanket material

- Temperature : $\sim 550^{\circ}\text{C}$
- Neutron energy : 14 MeV
- Radiation dose : ~ 200 dpa

- High resistance to irradiation
- Good thermo-physical and mechanical properties

RAFM steels

RAFM: Reduced-Activation Ferritic/Martensitic steels

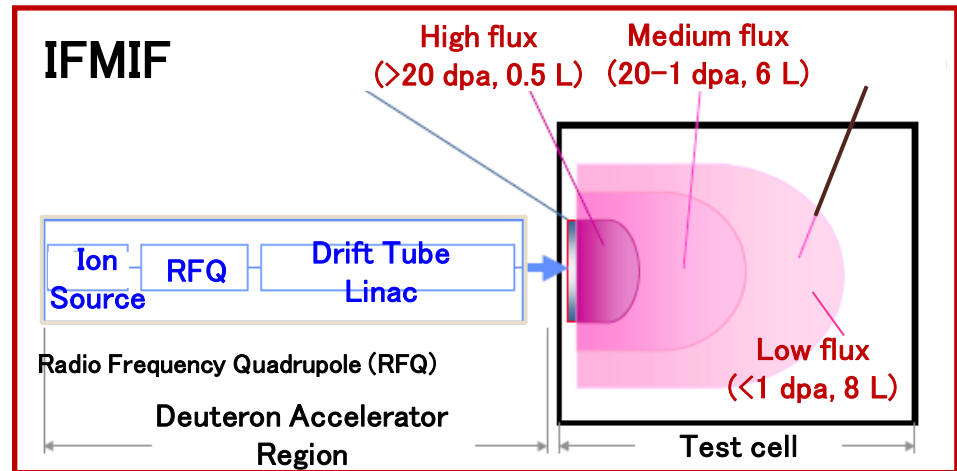

- The irradiation **volume** is very **limited**.
- Development of SSTT needs to effectively obtain the neutron irradiation data.

❖ Master curve method (ASTM E1921)

$$K_{Jc(\text{med})} = 30 + 70 \exp[0.019(T - T_0)]$$

- ❖ Master-curve method has been developed to evaluate irradiation embrittlement for pressure vessel steels.
- ❖ Master curve (MC) method is very useful to evaluate shift of ductile to brittle transition temperature by using limited number of small specimen.

Introduction (2/2)

Adjustment of thickness effect

Small specimen → Standard specimen

$K_{Jc(B)}$ → $K_{Jc(IT)}$

Prediction

30 MPa^m^{1/2} Thickness of small specimen

$$K_{Jc(IT)} = K_{Jc(\min)} + \left[K_{Jc(B')} - K_{Jc(\min)} \right] \left(\frac{B'}{IT} \right)^{1/4}$$

Fracture toughness of small specimen

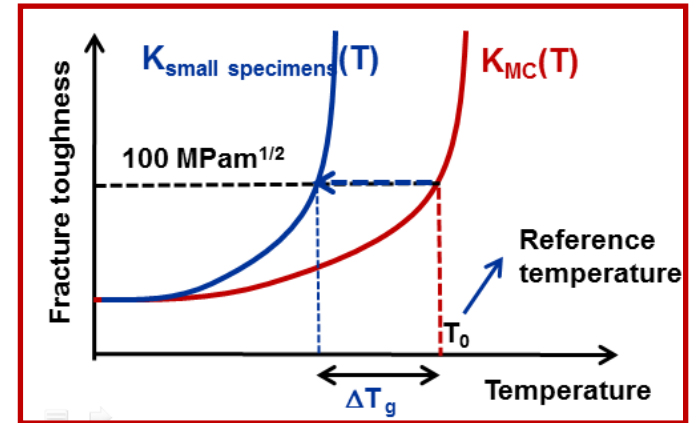

Problem of master curve method of the application to fusion structural materials

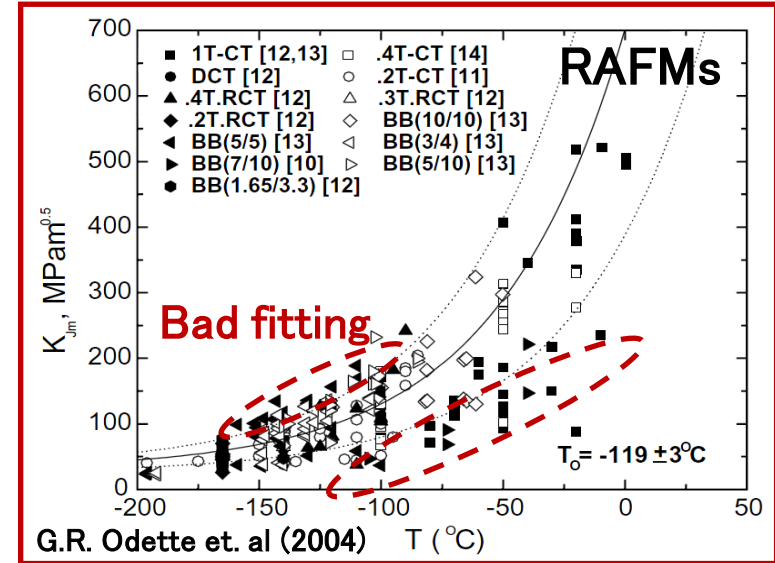
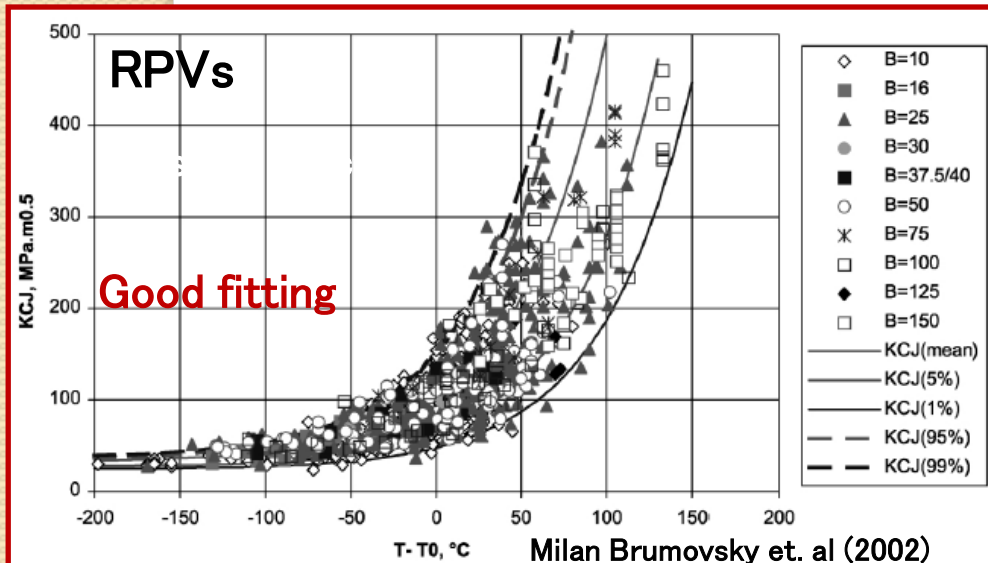

Experiment

Test materials: F82H-BA07-std

Chemical compositions of F82H steel

Materials	C	Si	Mn	P	S	Cr	W	V	Ta	N
F82H	0.09	0.11	0.16	0.002	0.002	8.0	1.88	0.19	0.02	0.017

Fracture toughness test

Master curve method (ASTM E1921)

$$K_{Jc(\text{med})} = 30 + 70 \exp[0.019(T - T_0)]$$

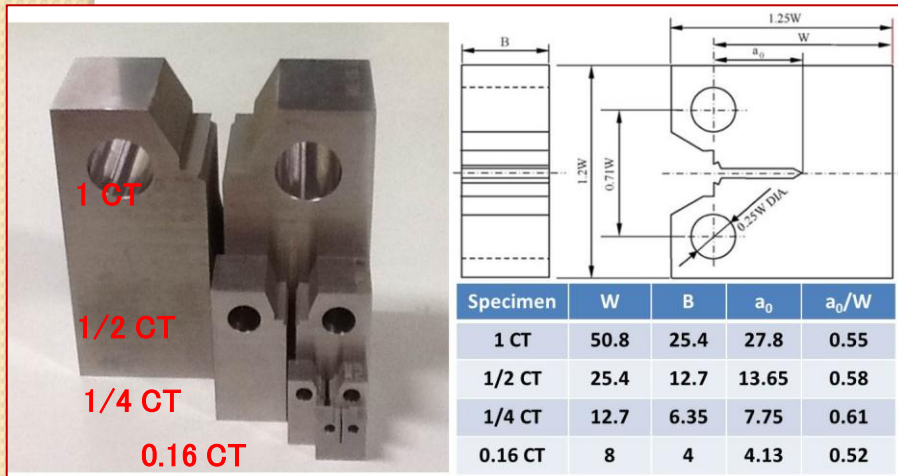

CT specimen (1 CT, 1/2 CT, 1/4 CT, 0.16 CT)



ASTM MC vs. New Modified MC analysis

ASTM master curve method

$$K_{JC(med)} = 30 + 70 \exp[0.019(T - T_0)]$$

Proposed master curve by KIM

$$K_{JC(med)} = 20 + 70 \exp[0.05(T - T_0)]$$

❖ Key point

① Change of parameter

❖ y-intercept : 30 → 20

❖ Slope of MC : 0.019 → 0.05

② Change of tolerance

boundary curve

❖ Calculation of standard deviation function

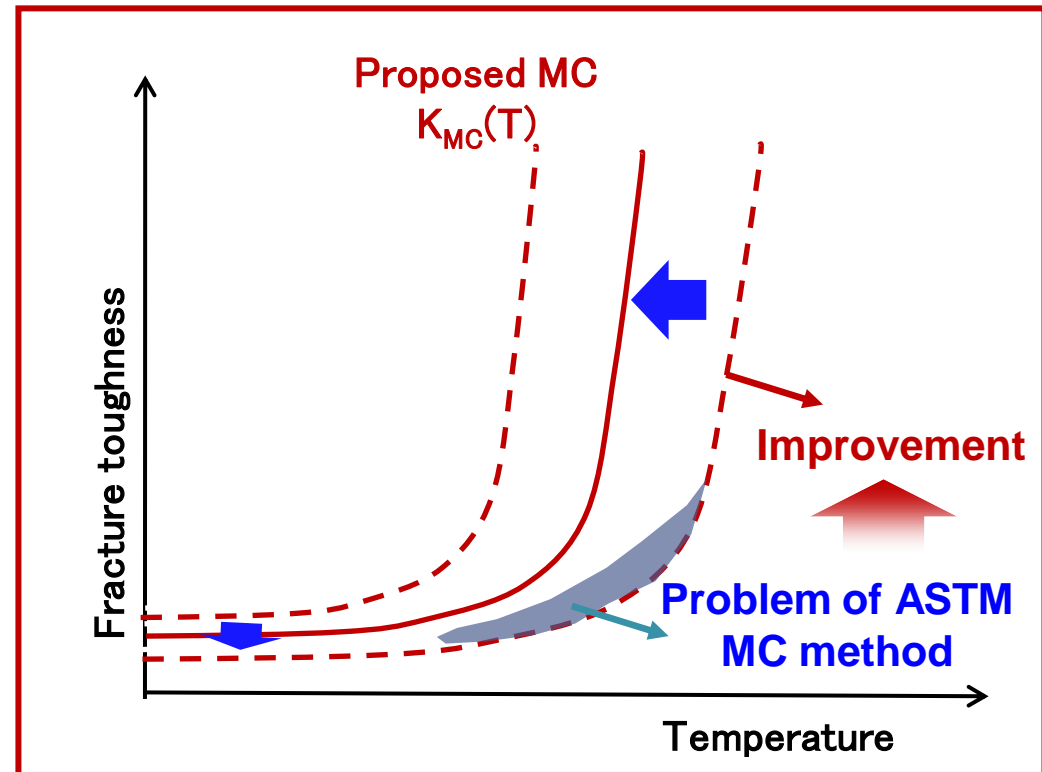

The proposed MC method can solve the problem of ASTM MC method which has many data below the lower boundary curve at the transition temperature region.

ASTM master curve analysis

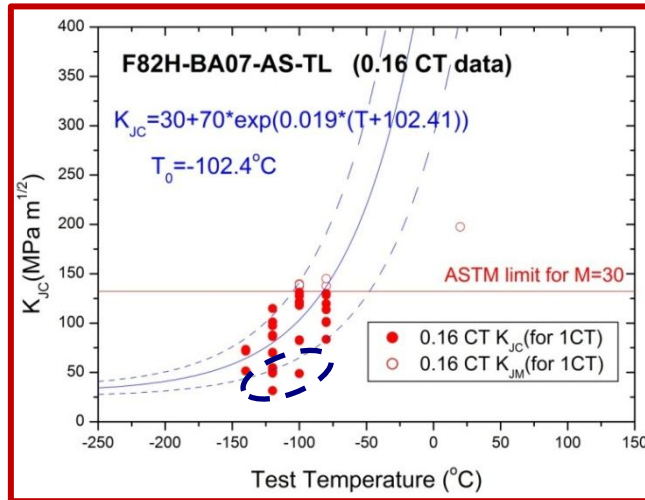
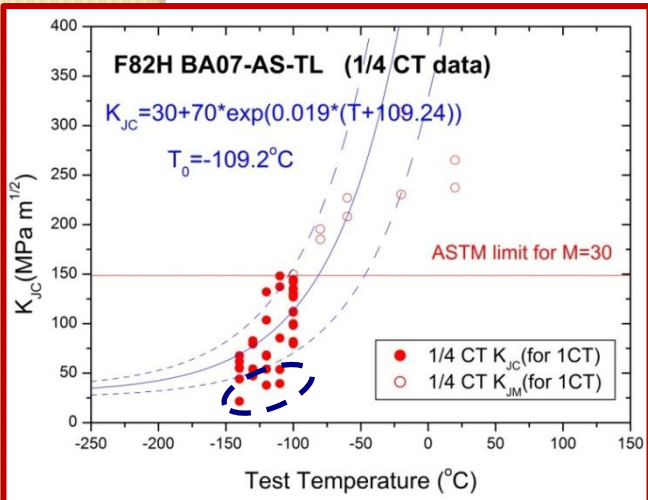
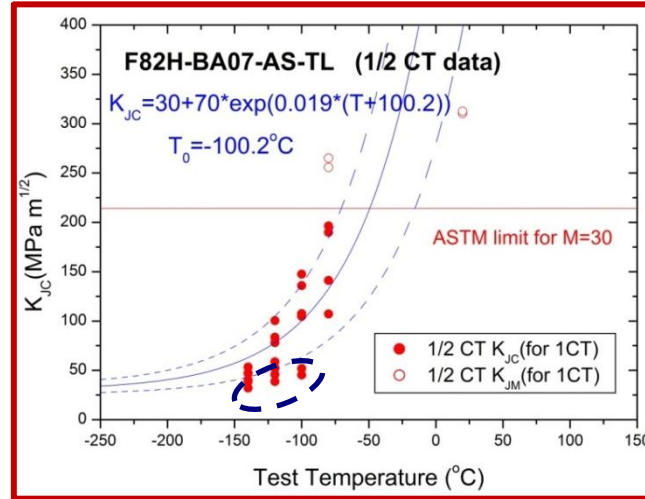
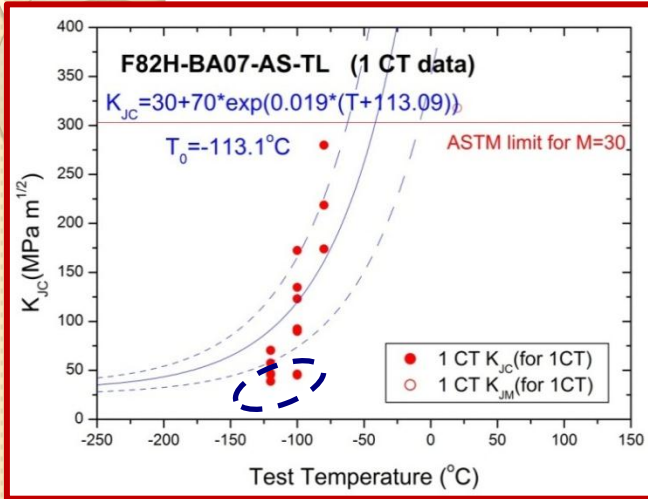

❖ The reference temperature (T_0) is randomly distributed according to specimen size.

❖ However, the difference of T_0 at the various size specimen is not a large about 10°C .

ASTM MC analysis can not be evaluated the reasonable estimate of data scatter, because there are many data below the lower boundary curve.

The random inhomogeneity analysis

❖ The random inhomogeneity (RI) analysis

- ❖ This analysis was suggested by Sokolov and Tanigawa (2007)
- ❖ The random inhomogeneity analysis is used all non-censored values to determine T_0 estimates
- ❖ RI analysis is consisted of T_0 and standard deviation function (σT_{0sp})

- The RI analysis provides a better description of the data scatter than conventional MC analysis.
- The reference temperature has smaller values (**15°C**) than conventional MC analysis.

➔ **RI analysis is not so good.**

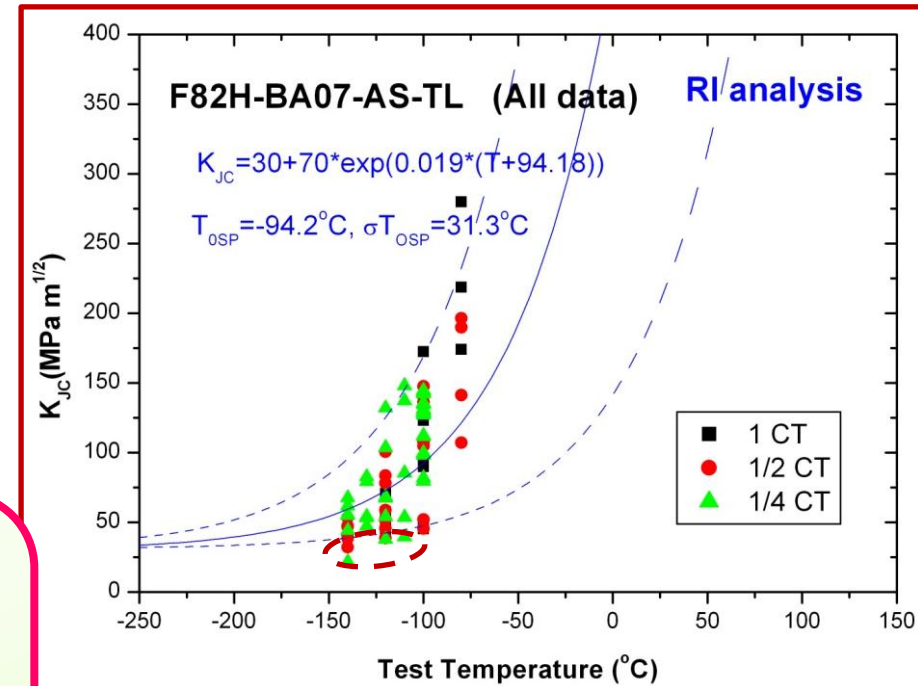

Total data : 101 data ➔ 8 data (7.9%) out of boundary curve

-. RI MC fitting is good. ➔ Not Enough
But, T_0 is bad.

New Modified Master Curve Analysis

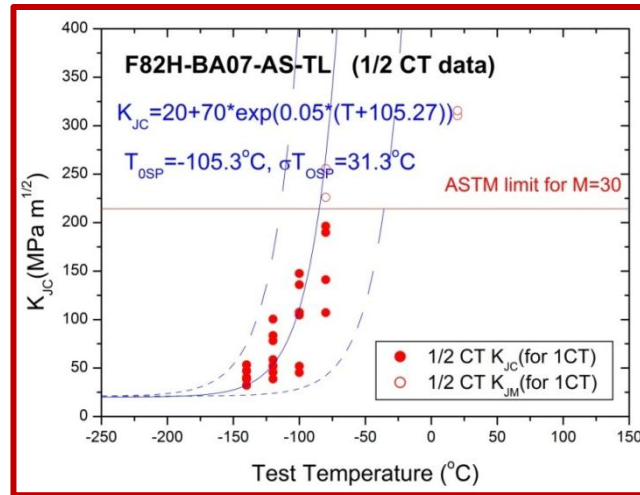
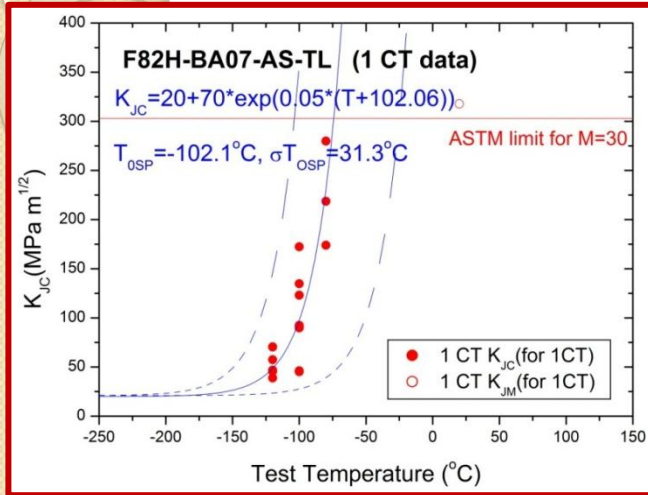

❖ As the specimen size is decreased, the reference temperature (T_0) is decreased.

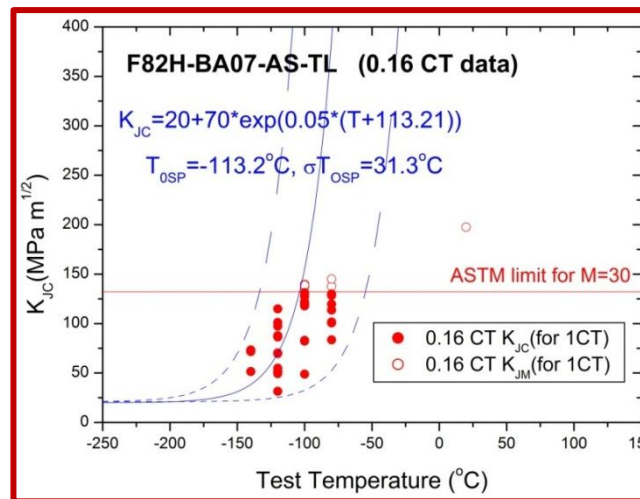
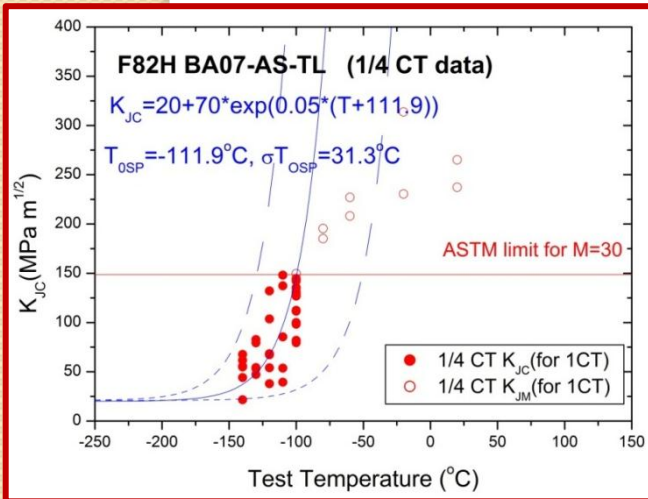

❖ However, the difference of T_0 at the various size specimen is not a large about 10°C

New Modified MC analysis can be evaluated the reasonable estimate of the data scatter, because all data are located inside of tolerance boundary curve.

ASTM MC vs. New Modified MC analysis

ASTM master curve method

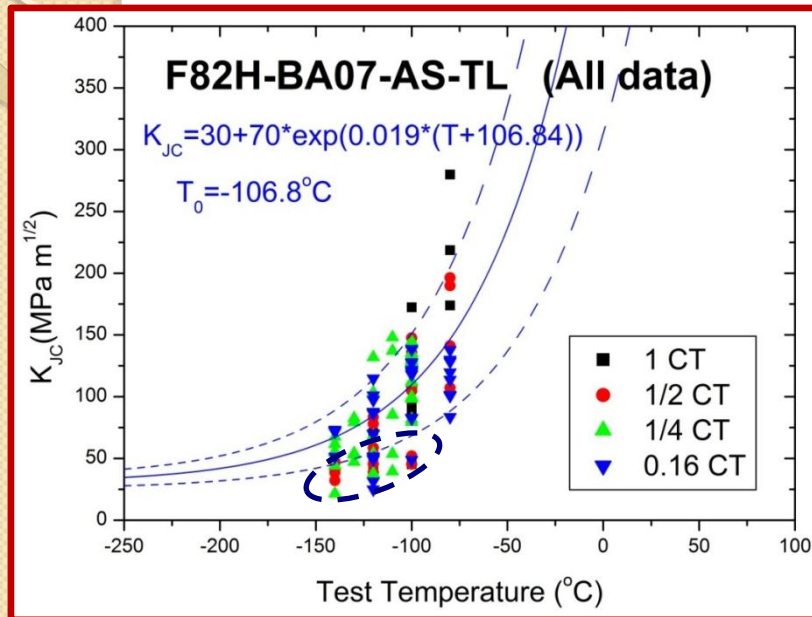

New Modified master curve

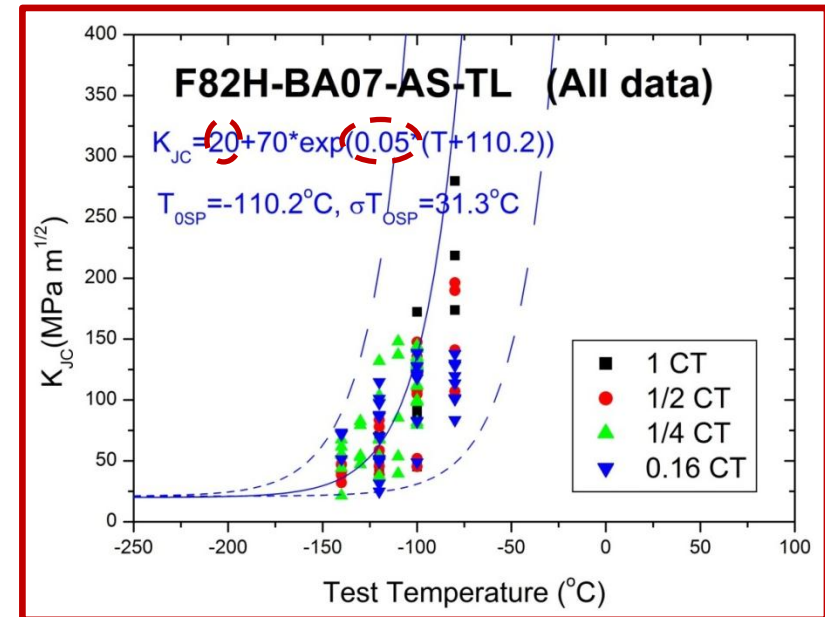

	ASTM MC analysis			New Modified MC analysis		
Specimen size	T_0	Out of data	Reliability	T_0	Reliability	Number of data
1 CT	-113.1	5	75%	-102.1	100 %	20
1/2 CT	-100.2	8	72%	-105.3	100 %	28
1/4 CT	-109.2	9	83%	-111.9	100 %	53
0.16 CT	-102.4	5	87%	-113.2	100 %	38
Total	-106.8	27	81%	-110.2	100 %	139

Effect of specimen size

Effect of specimen size

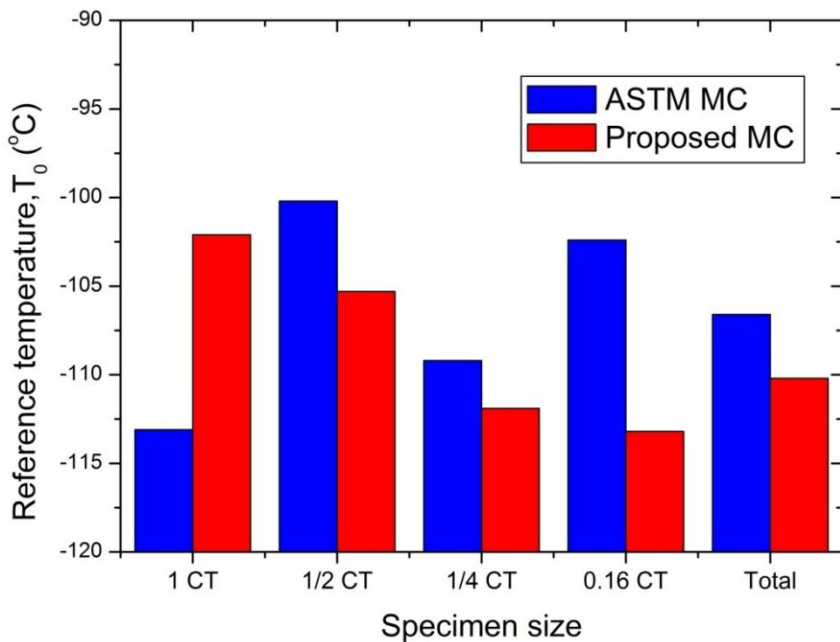

Relationship between specimen thickness and T_0

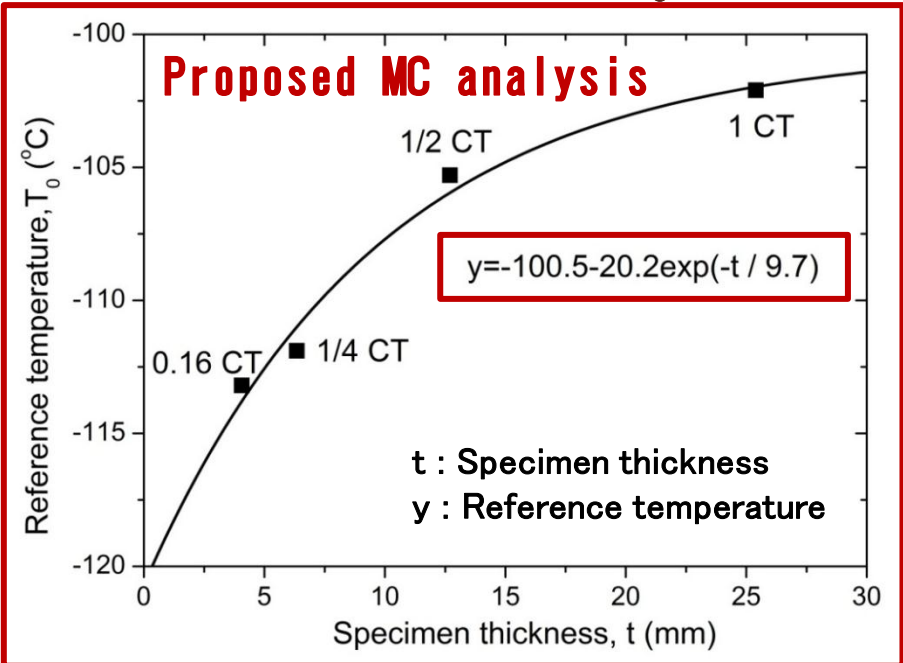

- ❑ In application of proposed MC analysis, we would be able to predict the reference temperature (T_0) of standard size specimen using the miniaturized CT specimen through our calculated equation.
- ❑ Small specimen test technique (SSTT) using the miniaturized CT specimen can be applicable to evaluate the fracture toughness for F82H steels.

Master Curve Analysis of F82H Using

Kurishita (Tohoku Univ.)

3Point Bending Small Size Specimens

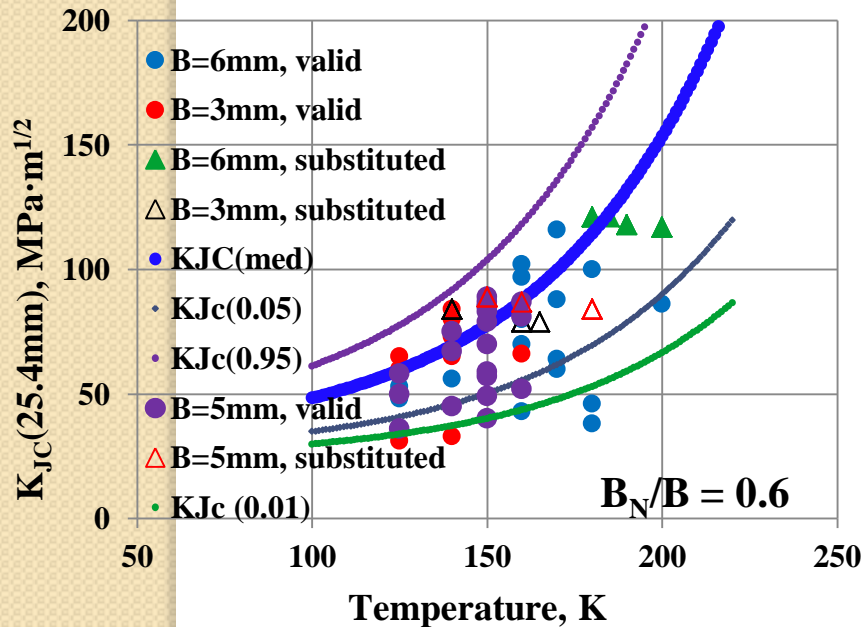

$$K_{Jc}(\text{med}) = 30 + 70 \exp\{0.019(T-170)\} \text{ MPam}^{0.5}$$

$$K_{Jc}(0.01) = 23.5 + 24.4 \exp\{0.019(T-170)\}$$

$$K_{Jc}(0.05) = 25.2 + 36.6 \exp\{0.019(T-170)\}$$

$$K_{Jc}(0.95) = 34.5 + 101.3 \exp\{0.019(T-170)\}$$

from ASTM code E1921

1. Dimensions for 3PB tests

$$3 \times 5 \times 25 \text{ mm}^3 \quad : \sim 1/8 T$$

$$5 \times 5 \times 25 \quad : \sim 1/5 T$$

$$6 \times 10 \times 50 \quad : \sim 1/4 T$$

2. Deep side -grooving required

□ $B_N/B = 0.6$ yields an analyzable dataset.

□ Most of the K_J values with $B_N/B = 0.7$ exceed the ligament constraint limit.

3. Reasonable T_0 value obtained

$T_0 = 170 \text{ K}$: similar to that from larger specimens or CT tests

4. Downward-shifting in the dataset

□ More data population below the lower bound than expected from the probability. (some of the data stay even below $K_{Jc}(0.01)$)

□ Seems contrary to the size effect: deep side-grooving effect?

Adjustment of the exp. term in the curve

Kurishita (Tohoku Univ.)

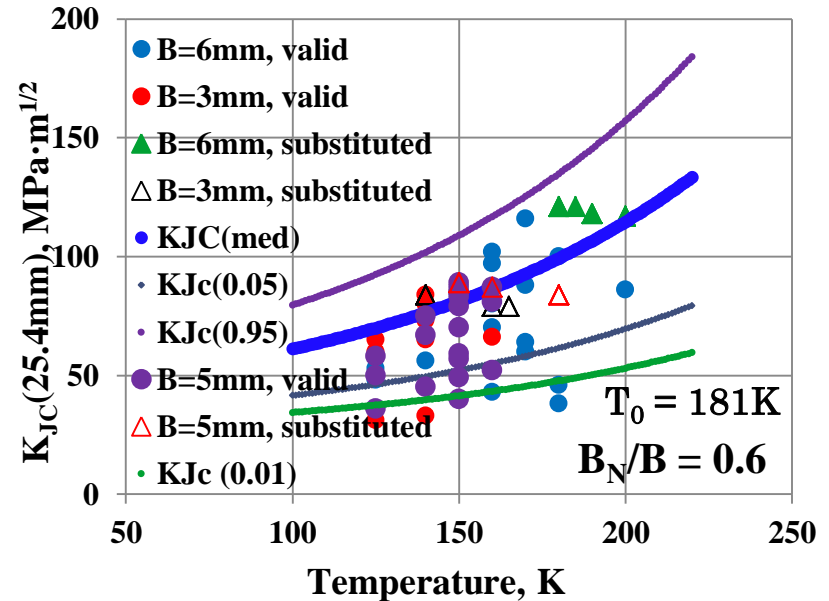
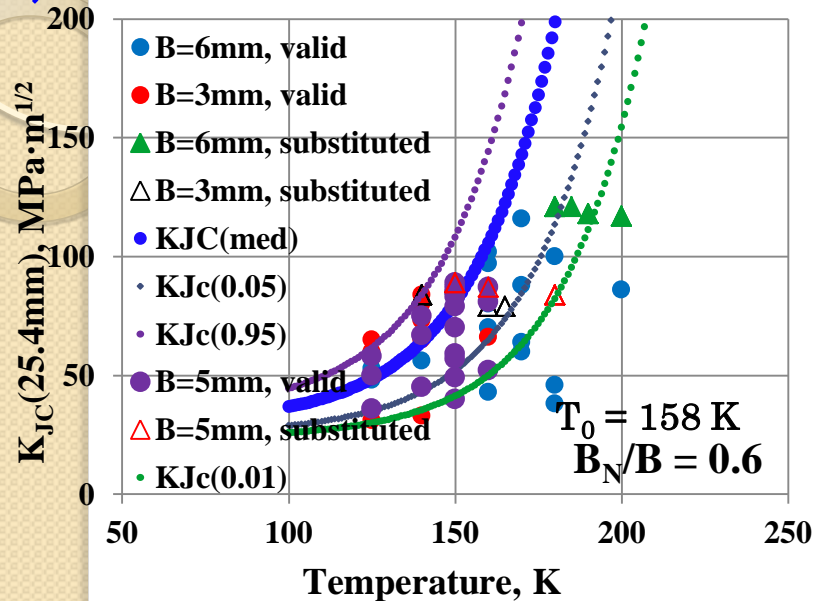

$$K_{Jc}(\text{med}) = 30 + 70 \exp\{0.04(T-158)\} \text{ MPam}^{0.5}$$

$$K_{Jc}(\text{med}) = 30 + 70 \exp\{0.01(T-181)\} \text{ MPam}^{0.5}$$

A modification from $\exp\{0.019(T-T_0)\}$ to $\exp\{0.04(T-T_0)\}$ was proposed for better data fitting (0.35T C(T)).

by R. Bonade, et al., J. Nucl. Mat., 367-370(2007)581

- 1) The modification does not improve overall fitting for the obtained data.
- 2) A smaller temperature dependence, $\exp\{0.01(T_0-T)\}$, does not also improve the data fitting.
- 3) The ASTM code provides a better result: needs to look for another type of modification?

Miniature Notched Tensile Test Method for Composites

T. Nozawa(JAEA)

- Beneficial to control crack propagation → improved reliability & reproducibility
- Need to identify the slow crack growth issue at elevated temperatures
→ Essential for lifetime prediction

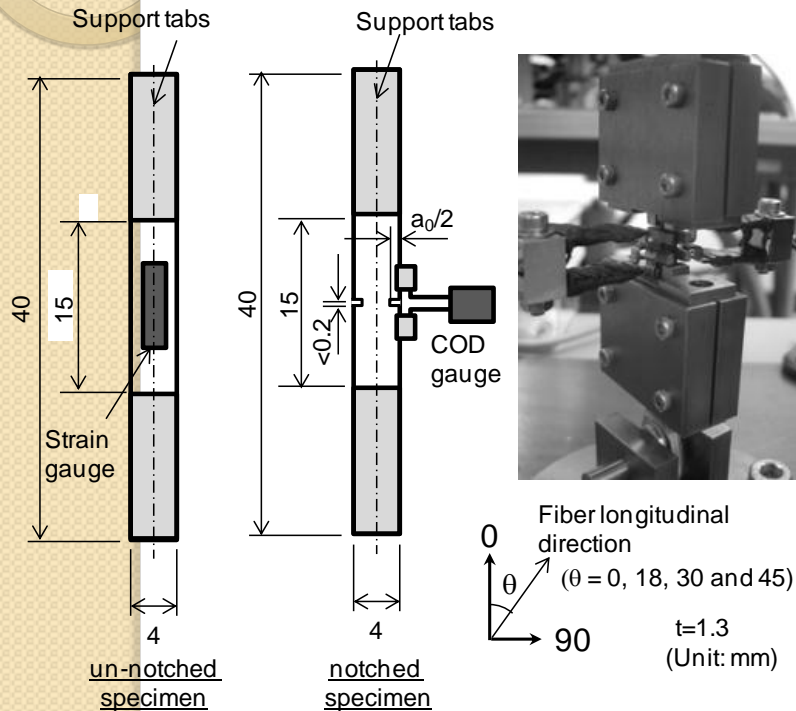

Miniature specimens developed in this R&D

T. Nozawa, et al, J. Nucl. Mater. 417 (2011) 440-444.

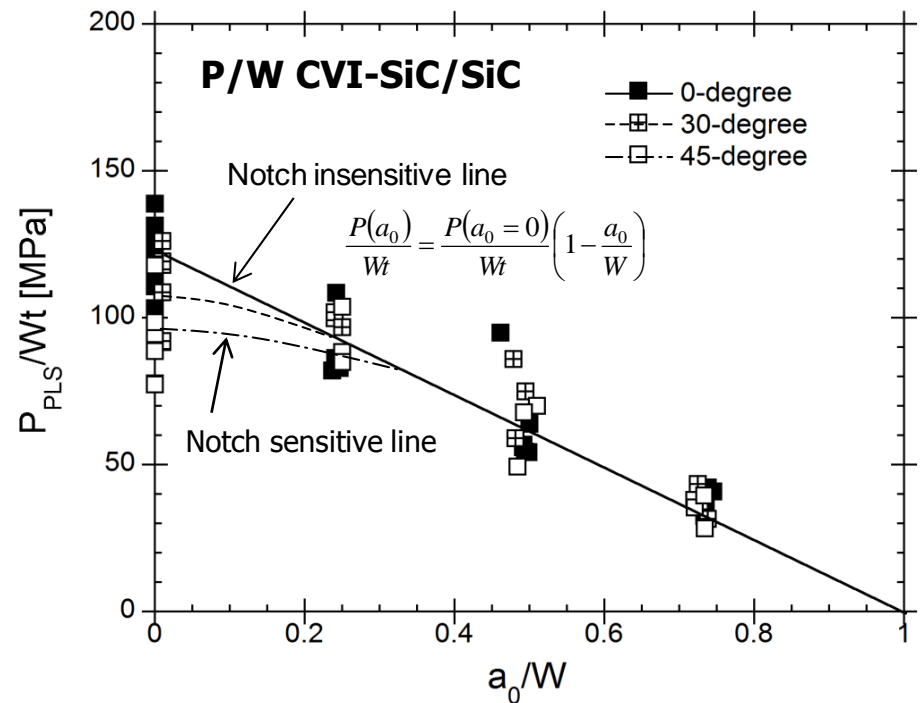

Evaluation of the notch effect on tensile properties

- Identifying notch insensitivity gives some implications about the correlation between energy and stress (strain) criteria.

Fracture Resistance Test Method for Composites

T. Nozawa(JAEA)

- Evaluation of “brittle-like” composites is essential for the design
- “Fracture toughness” based on linear fracture mechanics cannot be directly applied
- **New parameter of “fracture resistance” for brittle-like composites**

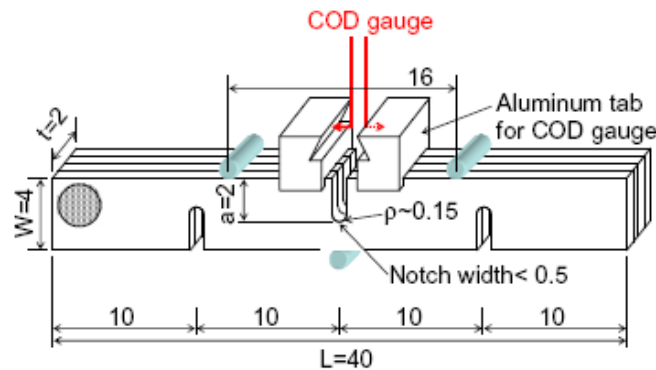
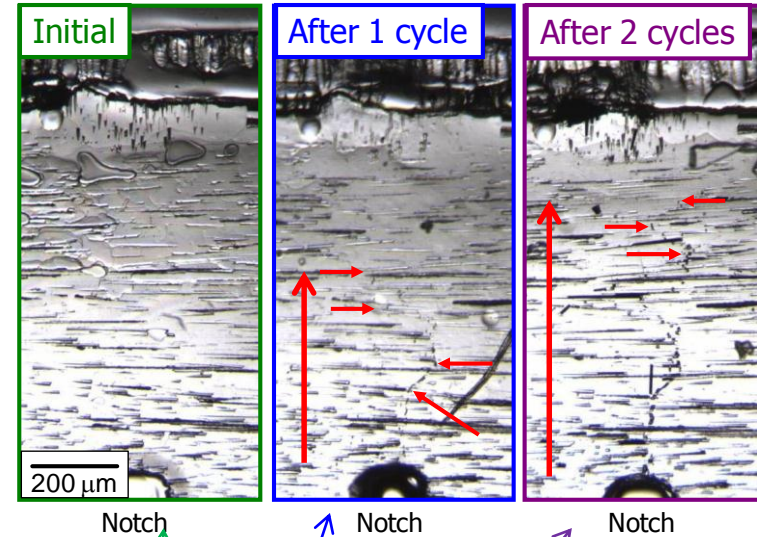

Fracture Resistance, G

$$G \equiv \frac{\partial \Gamma}{t \partial a} = \frac{\partial (\Gamma / Wt)}{\partial x} \frac{\partial x}{\partial (a/W)}$$

Γ : Crack surface formation energy
 t : specimen thickness
 W : specimen width
 a : initial crack depth
 x : load-line displacement

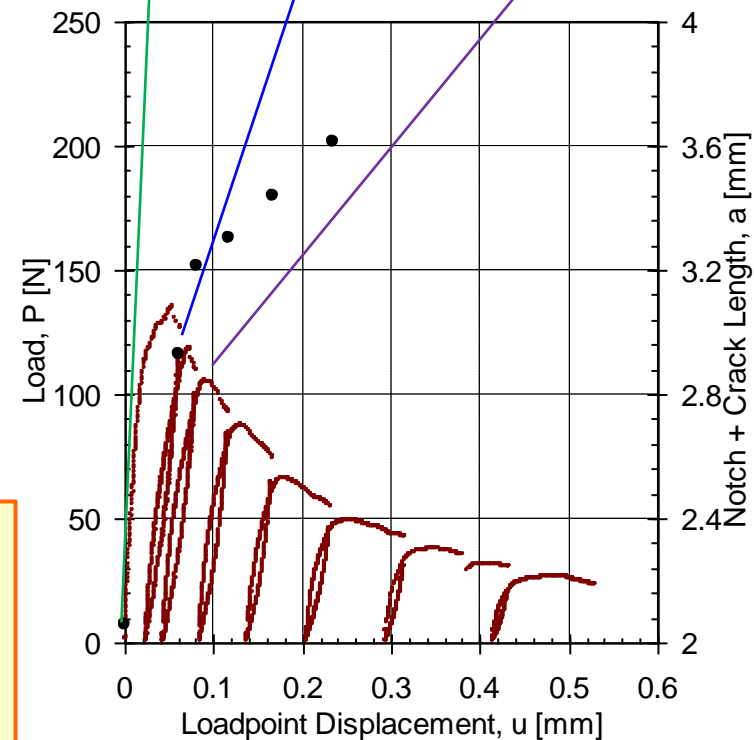

- Successfully applied to neutron irradiation study to show no radiation-induced degradation of fracture resistance

[K. Ozawa, et al., J. Nucl. Mater. 417 (2011) 411-415]