

# Mu2e Experiment and Issues

Rick Coleman, Fermilab  
RESMM'12, February 2012

# Muze talks

- **Today**

- **Now: Muze Experiment and Issues**

- **Overview, Status of Project, Production & Transport Solenoids**

- **16:30 Superconducting Magnets of Muze- Michael Lamm**

- **17:00 Muze Production Solenoid- Vadim Kashikhin**

- **Tuesday**

- **16:00 Radiation Studies for Muze Magnets- Vitaly Pronskikh**

Special Thanks to: R. Bernstein, J. Miller, D. Glenzinski, for some material used

# Introduction

- Mu2e experiment is a search for Charged Lepton Flavor Violation (CLFV) via the coherent conversion of  $\mu^- N \rightarrow e^- N$
- In wide array of New Physics models CLFV processes occur at rates we can observe with next generation experiments
- The proposed experiment uses current proton source at Fermilab with some modifications
- Target sensitivity has great discovery potential

Current limits: 
$$R_{\mu e} = \frac{\mu^- Au \rightarrow e^- Au}{\mu^- Au \rightarrow \text{capture}} < 7 \times 10^{-13} \text{ (SINDRUM II)}$$

Mu2e goal: 
$$R_{\mu e} = \frac{\mu^- Al \rightarrow e^- Al}{\mu^- Al \rightarrow \text{capture}} < 6 \times 10^{-17} \text{ (90\% c.l.)}$$



# Collaboration

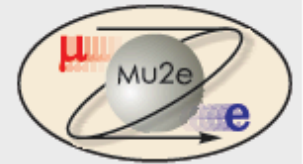

*Boston University*

*Brookhaven National Laboratory*

*University of California, Berkeley*

*University of California, Irvine*

*California Institute of Technology*

*City University of New York*

*Duke University*

*Fermilab*

*University of Houston*

*University of Illinois, Urbana-Champaign*

*University of Massachusetts, Amherst*

*Lawrence Berkeley National Laboratory*

*Los Alamos National Laboratory*

*Northwestern University*

*Rice University*

*Syracuse University*

*University of Virginia*

*University of Washington, Seattle*



*Istituto G. Marconi Roma*

*Laboratori Nazionali di Frascati*

*Università di Pisa, Pisa*

*Università del Salento*

*Gruppo Collegato di Udine*



*Institute for Nuclear Research, Moscow, Russia*

*JINR, Dubna, Russia*

**~130 collaborators**

# The Measurement Method

- Stop negative muons in an **aluminum** target
- The stopped muons form muonic atoms
  - 207x smaller radius than inner  $e^-$  in Al  $\rightarrow$  well inside electron orbits  $\rightarrow$  muon forms a hydrogen-like atom, unaffected by  $e^-$ 's
  - hydrogenic 1S : Bohr radius  $\sim 20$  fm, BE  $\sim 500$  keV
  - Nuclear radius  $\sim 4$  fm  $\rightarrow$  muon and nuclear wavefunctions overlap significantly
- Three main things can happen:
  - Muon decays (40%):  $\mu^- \rightarrow e^- + \bar{\nu}_e + \nu_\mu$
  - Muon captures on the nucleus (60%):  $\mu^- + {}_{13}^{27}\text{Al} \rightarrow X + \nu_\mu$
  - Muon to electron conversion:  $\mu^- + {}_{13}^{27}\text{Al} \rightarrow {}_{13}^{27}\text{Al} + e^-$
- Muon lifetime in 1S orbit of aluminum  $\sim 864$  ns (40% decay, 60% nuclear capture), compared to 2.2  $\mu\text{sec}$  in vacuum
- Look for 105 MeV electron signal  
This energy is well above the most copious sources of backgrounds

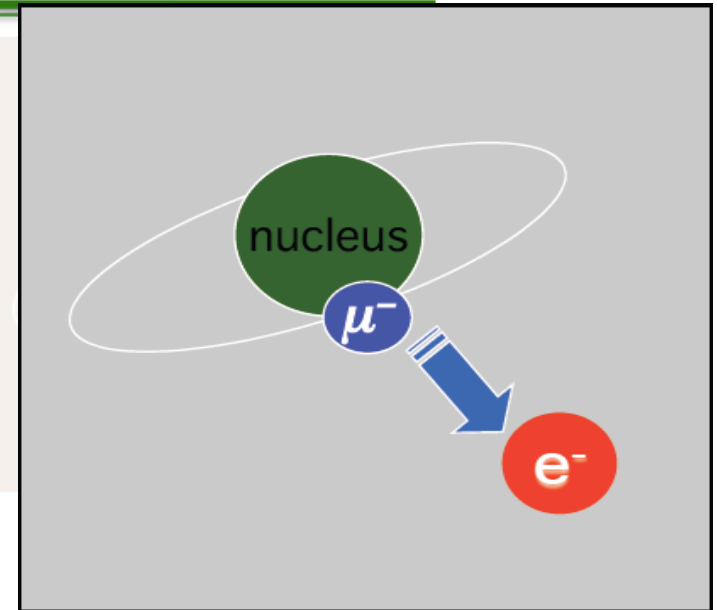

# Beam Intensity and Pulsed Proton Beam

- Deliver high flux  $\mu^-$  beam to stopping target
  - proton flux  $\sim 6 \times 10^{12}$  /sec at 8 GeV (8 kW)
  - $\sim 2 \times 10^{10}$  Hz  $\mu^-$ ,  $10^{18}$  total, 4 conversion  $e^-$  at  $R_{\mu e} \sim 10^{-16}$
  - $10^3$  more muons than SINDRUM II previous best limit
- Pulsed Proton beam – Wait 670 ns to reduce prompt background, extinction =  $10^{-10}$  using Debuncher Ring and oscillating (AC) dipole sweeper in external proton beamline

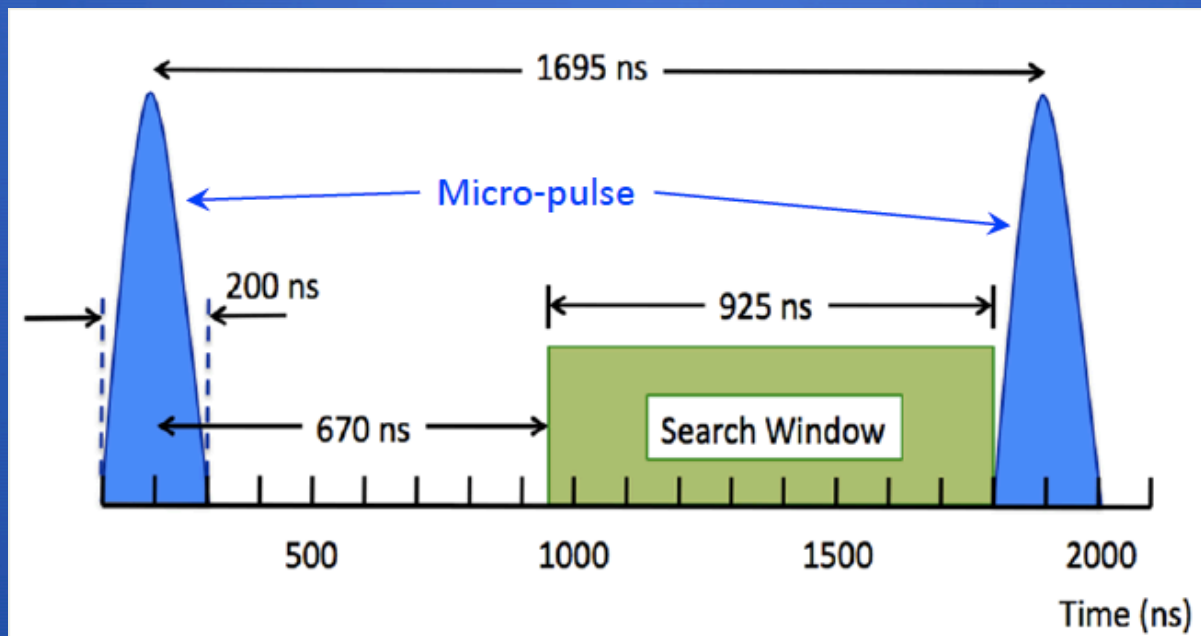

$$\tau_{\mu}(\text{Al}) = 864 \text{ ns}$$

# Pulsed Beam and Radiative Pion Capture Background

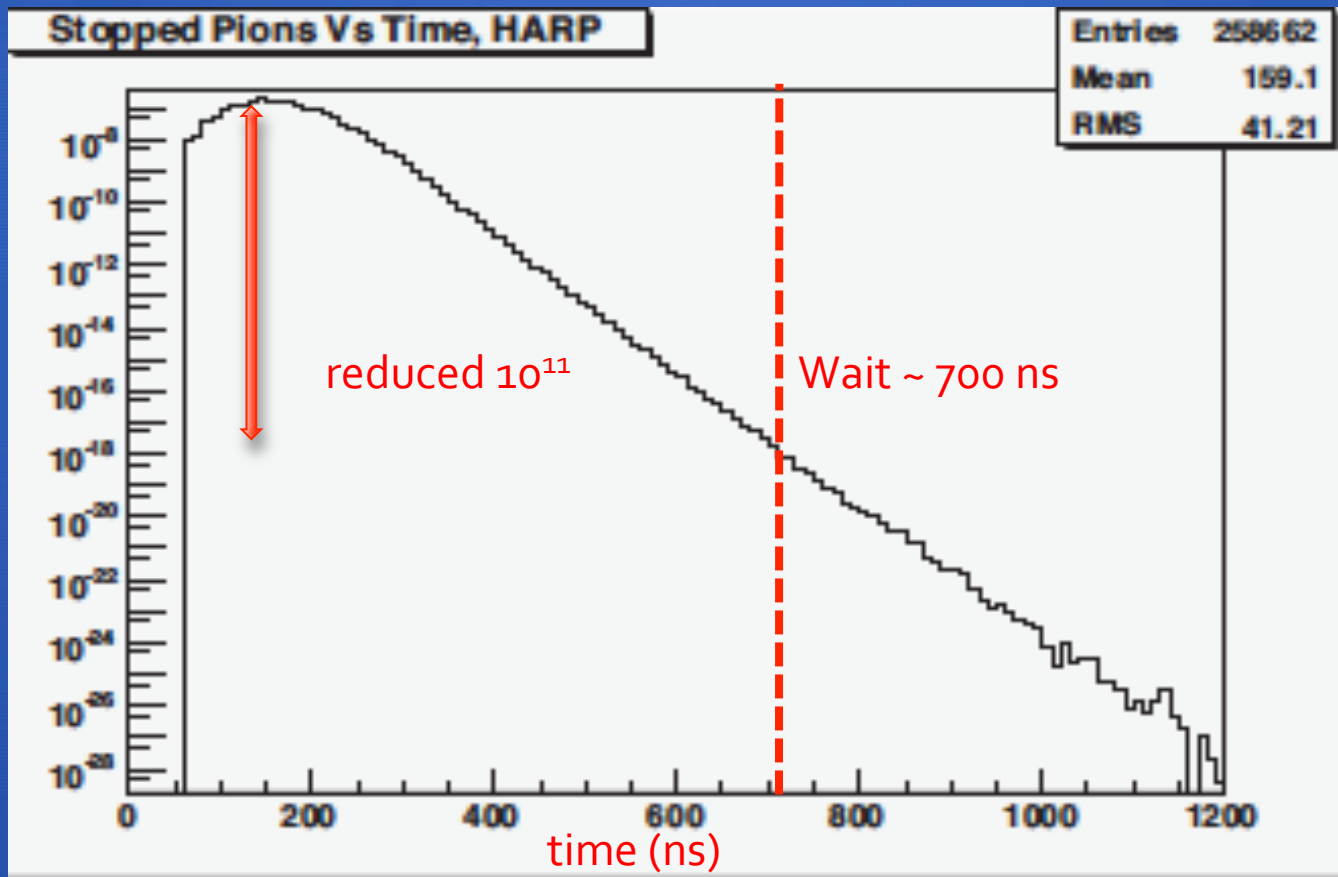
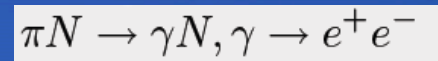

# Protons from 8 GeV Booster to Mu2e



New beamline shared by Mu2e and g-2

Steve Werkema



# Muon Campus for Mu2e and g-2 with Cryo Plant

- g-2 building (MC-1) has evolved to support needs of g-2 and Muze
- Low bay is Muon Campus Cryo Building
  - Medium Bay will house beamline power supplies and equipment.

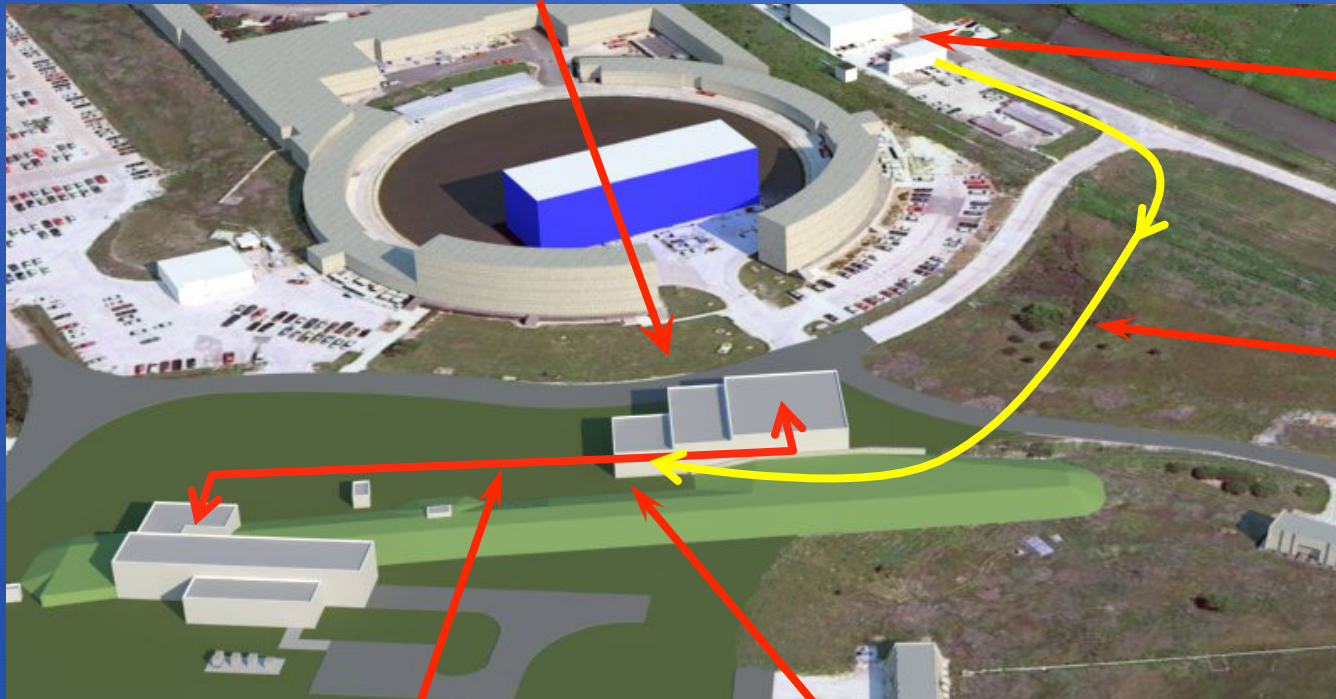

Compressed He from existing TeV compressors

New transfer line for compressed He built from recycled parts

Cold He lines to experiments

Three TeV refrigerators installed in MC-1

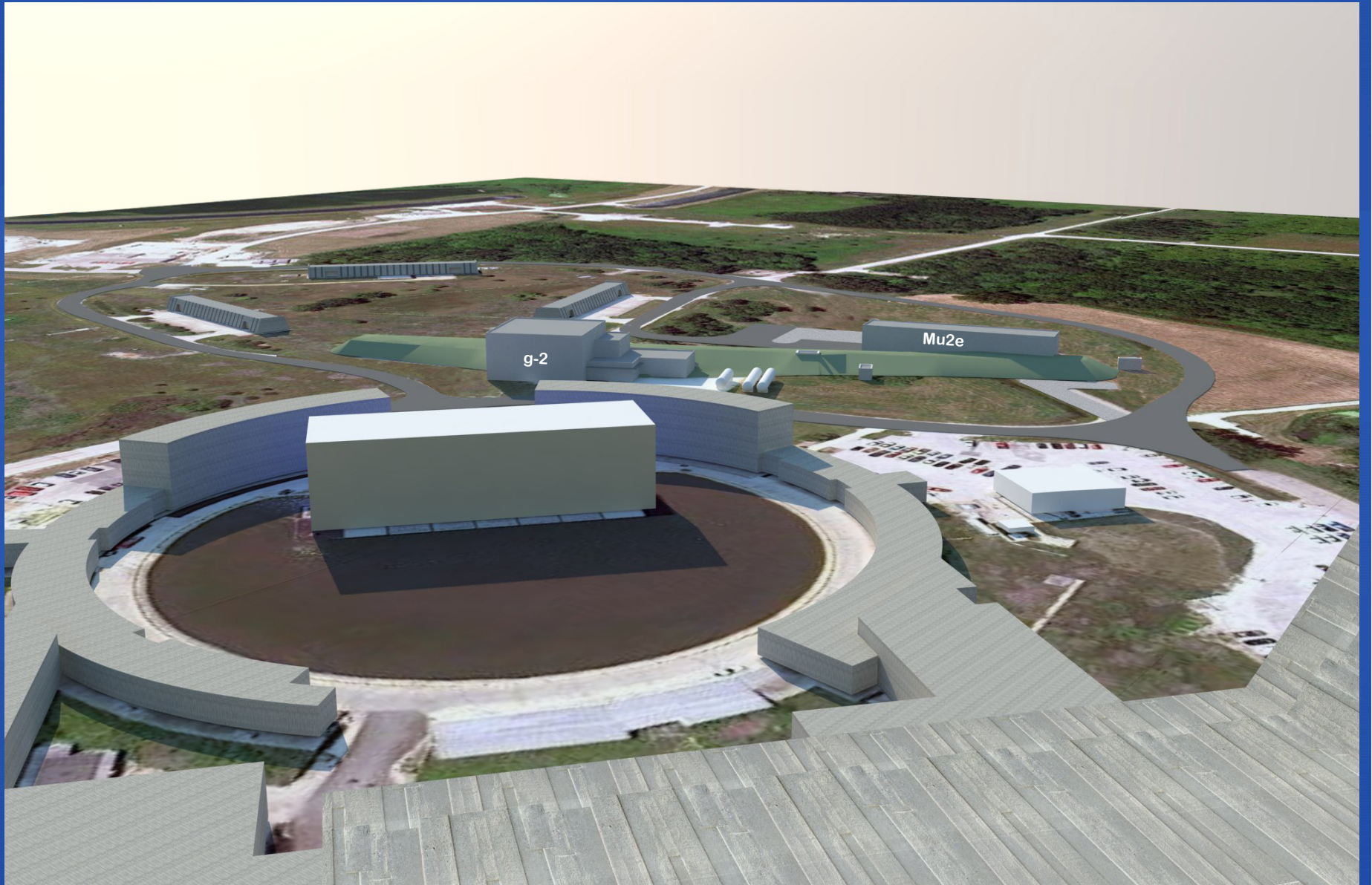

# Schedule

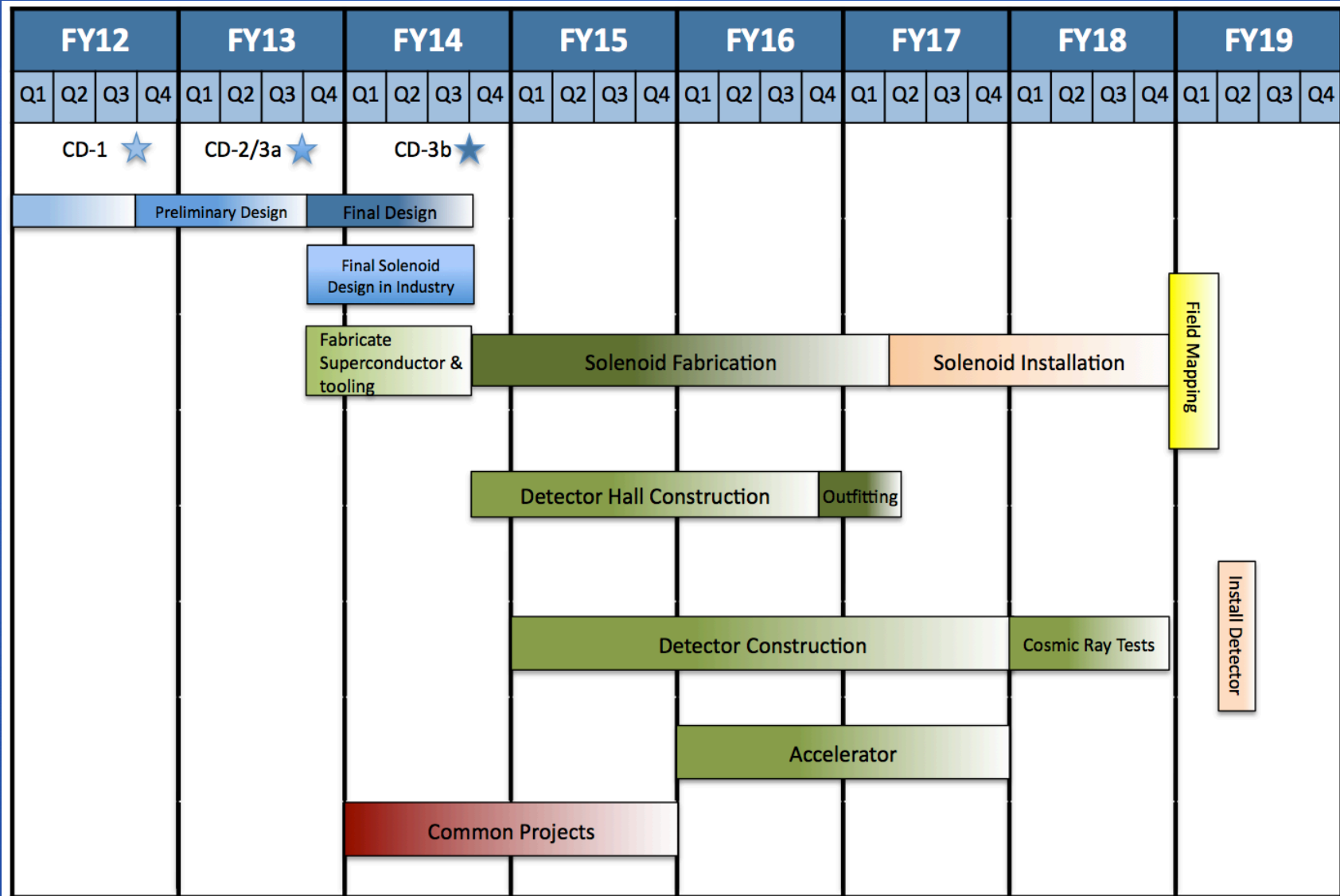

LETTERS TO THE EDITOR

On the search for the  $\mu \rightarrow e$  conversion process in a nucleus

R. M. Dzhilkibaev and V. M. Lobashev

*Institute of Nuclear Research, USSR Academy of Sciences*

(Submitted 21 June 1988)

*Yad. Fiz.* **49**, 622–624 (February 1989)

$\mu/p \sim 10^{-4}$  vs  
conventional  $\sim 10^{-8}$

MELC at Moscow

1989

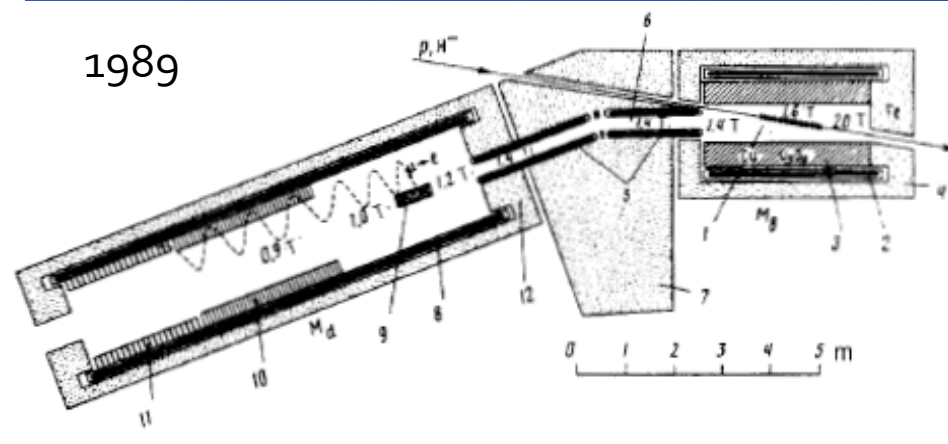

MECO at BNL

1996-2005

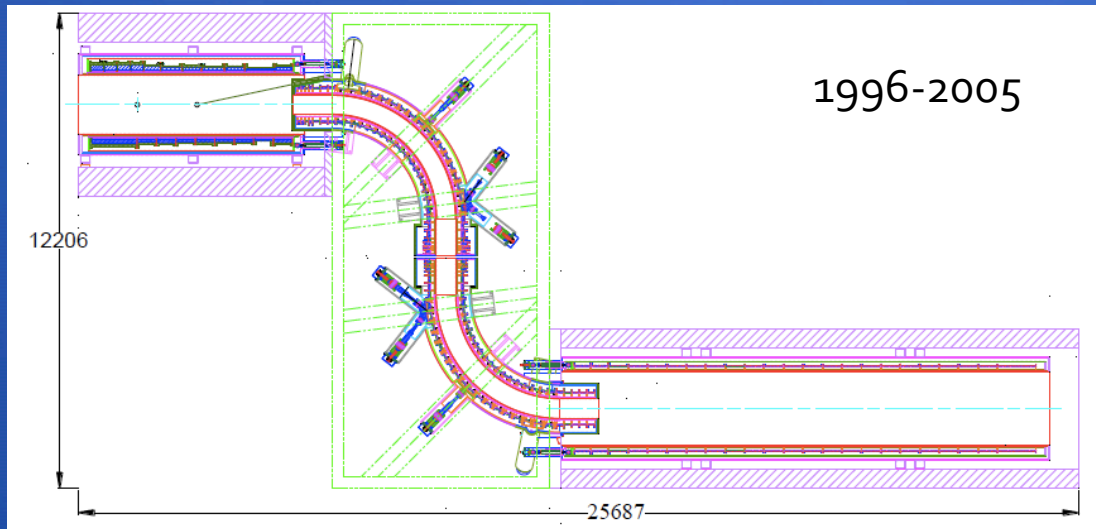

COMET at J-PARC: proposal Nov 2007 & Muze at FNAL: proposal Oct 2008

# Muze Apparatus

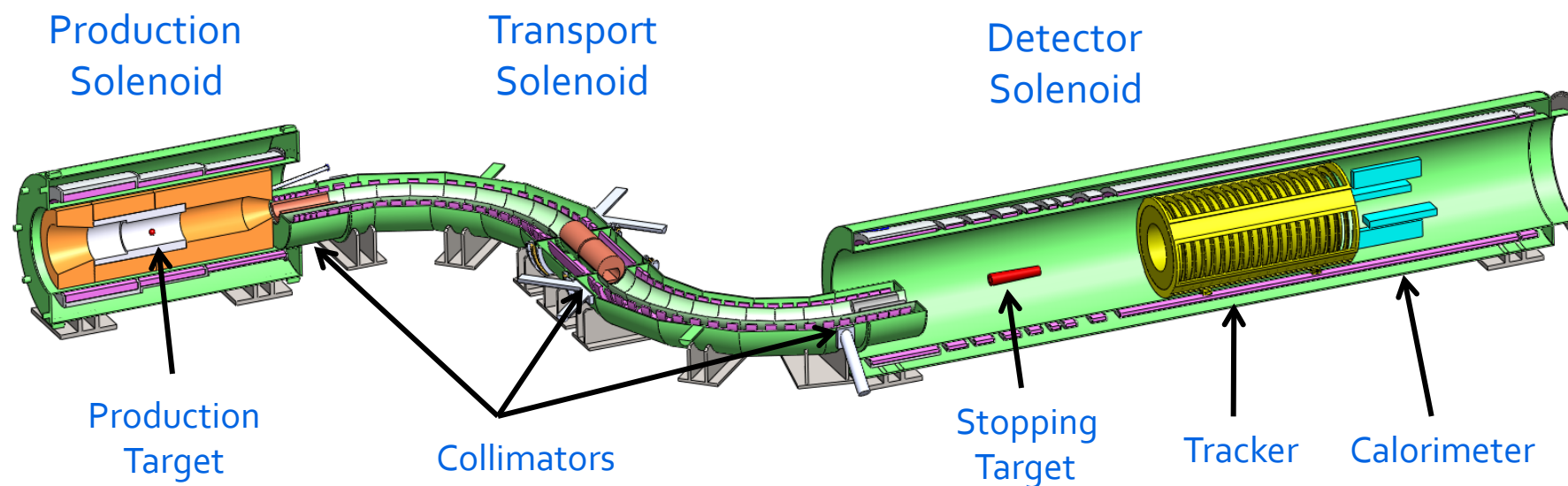

(not shown: Cosmic Ray Veto, Proton Dump, Muon Dump, Proton/Neutron absorbers, Extinction Monitor, Stopping Monitor)

- Muze experiment consists of 3 solenoid systems

# Muze Apparatus

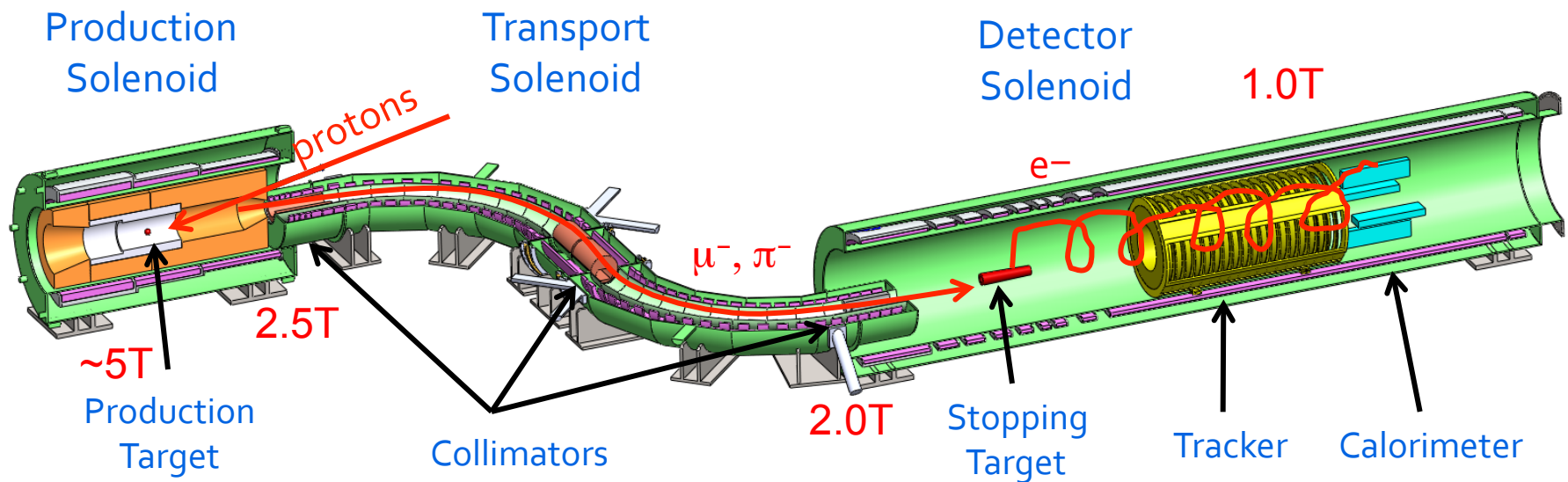

(not shown: Cosmic Ray Veto, Proton Dump, Muon Dump, Proton/Neutron absorbers, Extinction Monitor, Stopping Monitor)

- Muze experiment consists of 3 solenoid systems

# Transport Solenoid

Inner radius=24 cm

Length=13.11 m

TS1: L=1 m

TS2: R=2.9 m

TS3: L=2 m

TS4: R=2.9 m

TS5: L=1 m

## Goals:

- Transport low energy  $\mu^-$  to the detector solenoid
- Minimize transport of positive particles and high energy particles
- Minimize transport of neutral particles
- Absorb antiprotons in a thin window
- Minimize particles with long transit time

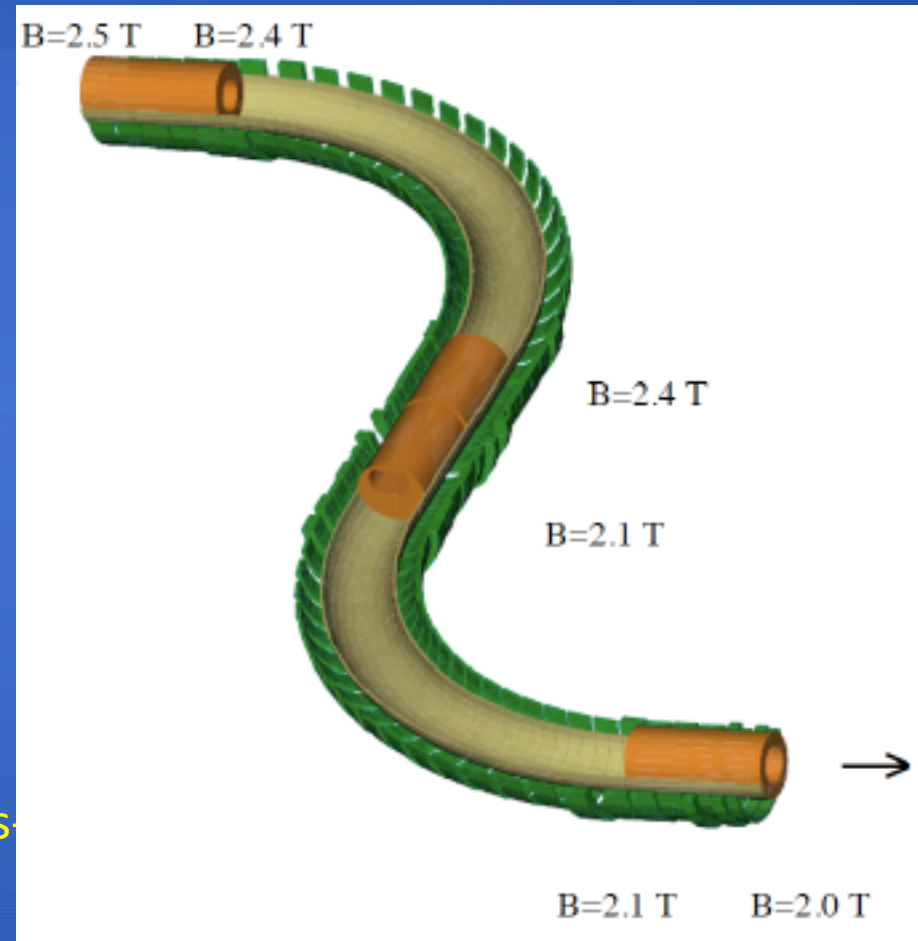

# Charge, Momentum Selection and Rejection of Long-lived Particles

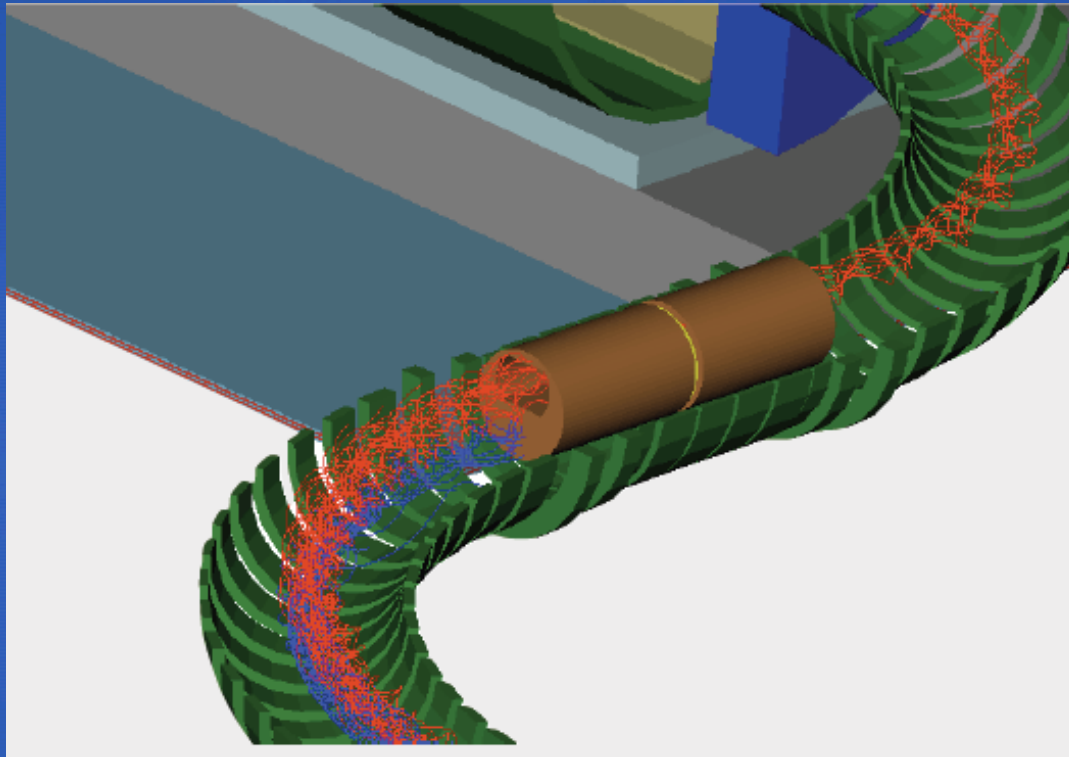

## Vertical Drift Motion in a Toroid

Toroidal Field:  $B_s = \text{constant} \times 1/r$ . This gives a large  $dB_s/dr$

Particle spiral drifts vertically (perpendicular to the plane of the toroid bend):

$D$  = vertical drift distance  
 $R$  = major toroid radius,  
 $s/R$  = toroid angle =  $90^\circ$   
 $D$  [m] = distance,  $B$  [T],  $p$  [GeV/c]

$$\text{Define pitch } = \alpha = \frac{p_l}{p}$$

$$\rightarrow D = \frac{q}{0.3 \times B} \times \frac{s}{R} \times \frac{1}{2} p \left( \frac{1}{\alpha} + \alpha \right).$$

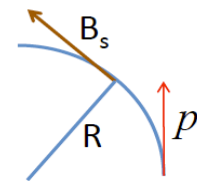



# Muon Flux- before and after Transport Solenoid

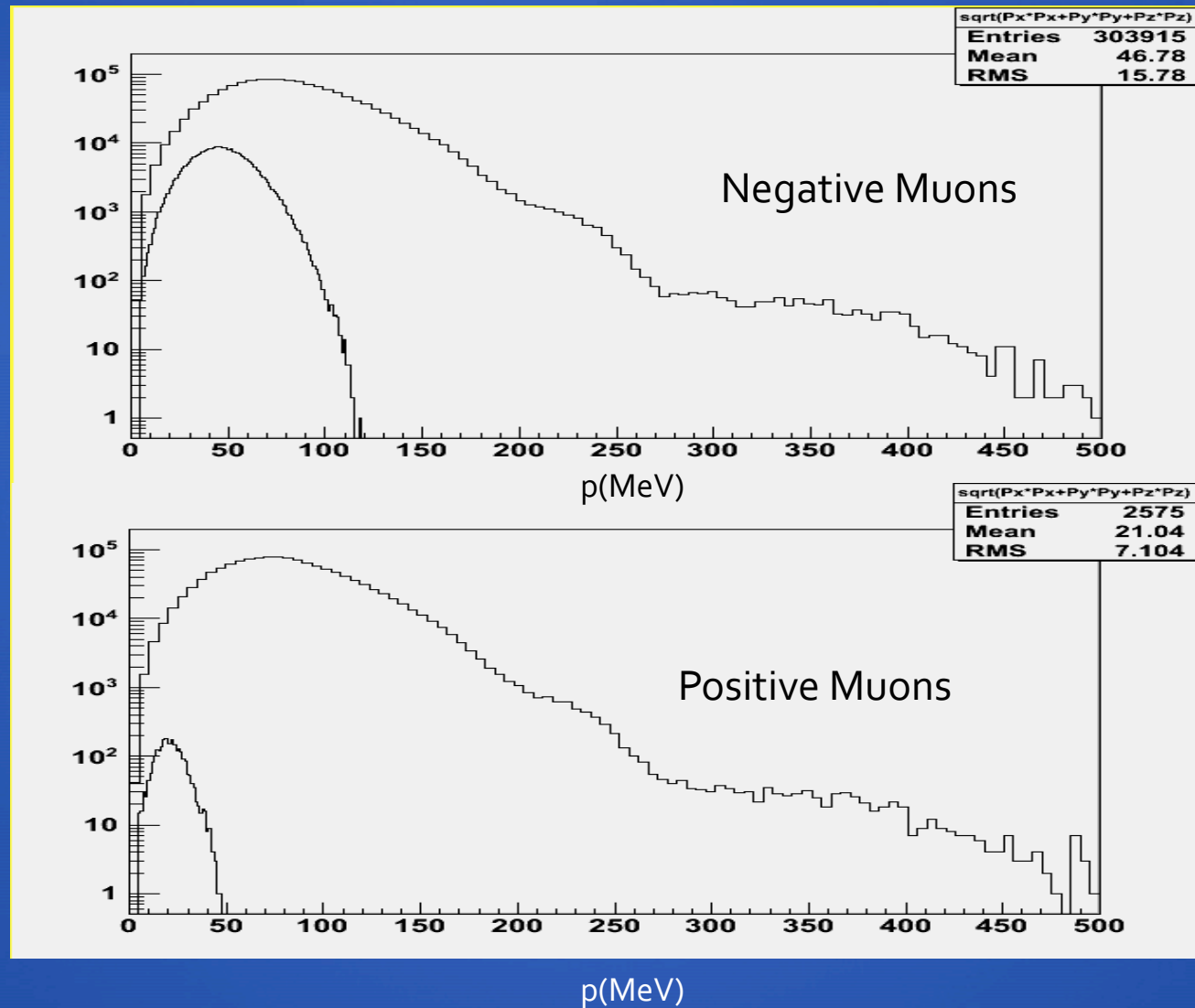

## Muons Reaching the Stopping Target in the Detector Solenoid

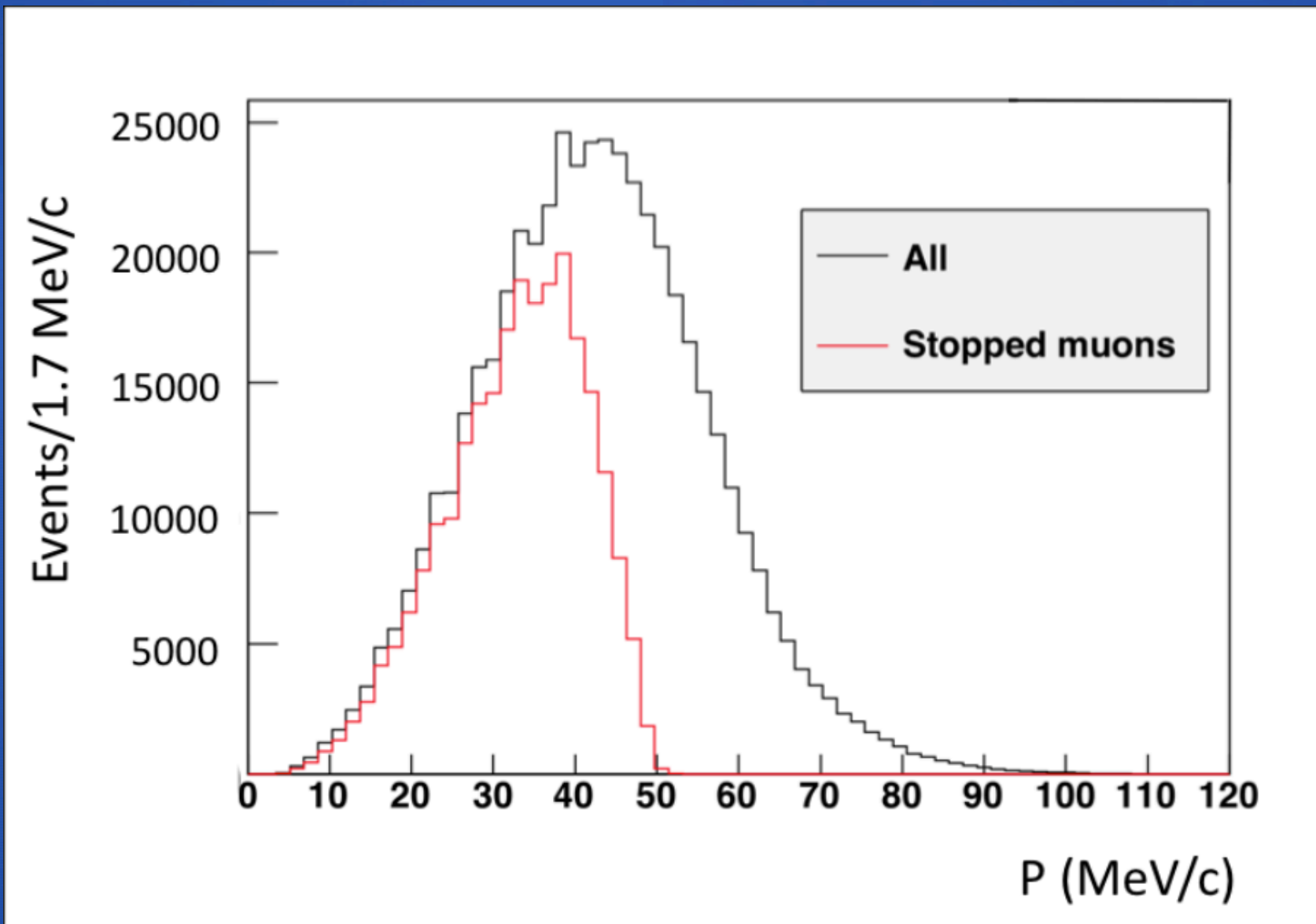

# Production Solenoid

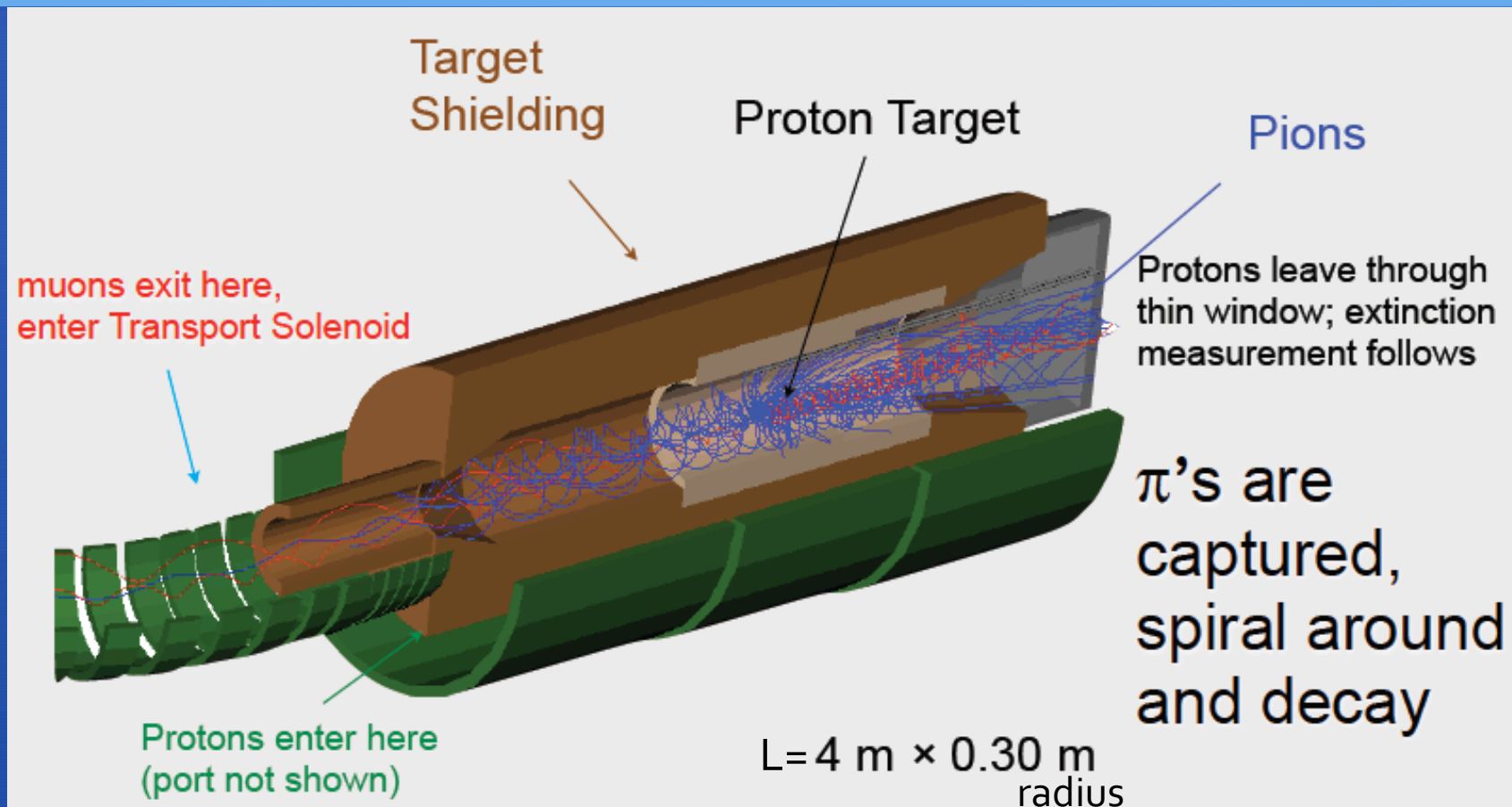

# Heat and Radiation Shield Dimensions from Simulation

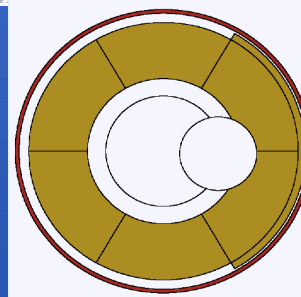
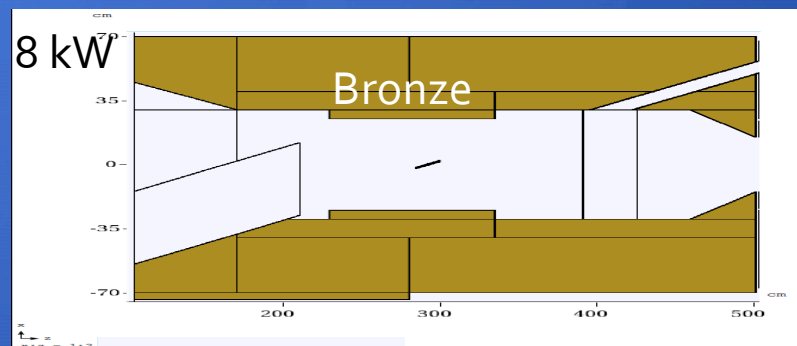
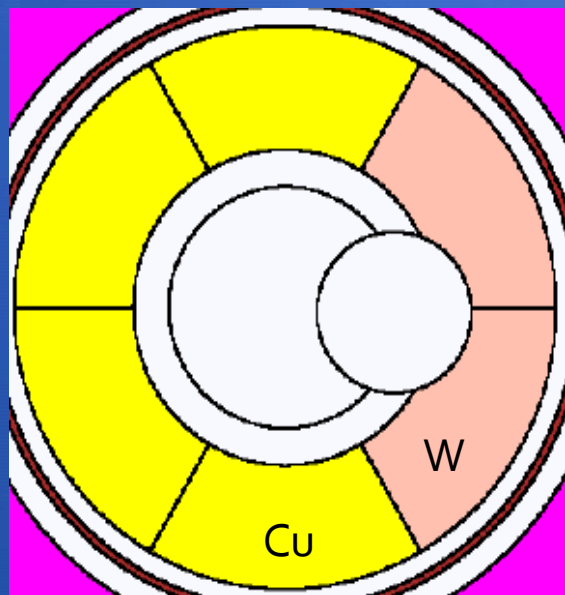
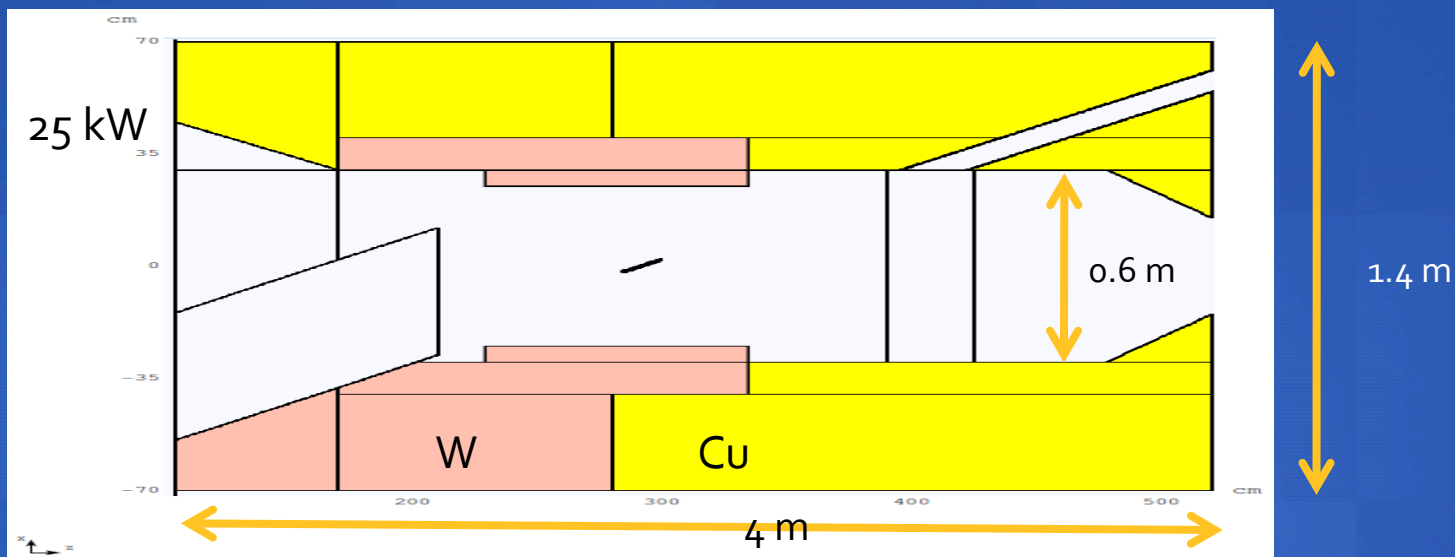

*See Vitaly Pronskikh's  
talk  
tomorrow*

# Some Early Comparisons to MECO (2009)

	MECO	G4beamline
Stopped muon yield per proton incident	0.0022-0.0025	0.0022
PS mirror removed	~0.7	0.79
PS bore radius 25 cm to 20 cm	0.96	0.92
Proton beam angle 12 -> 5 deg	0.98	0.98
Target radius 3 mm-> 6mm	0.65	0.64
Target L= 16 to 12 cm	0.91	0.92
Target L=16 to 20	0.99	0.96
Target z position in PS	See next plot	
PS max field	See next plot	

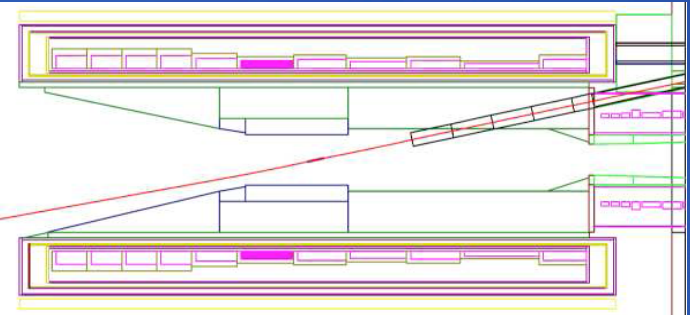

## Study of Muon Yield vs Maximum Field in Production Solenoid

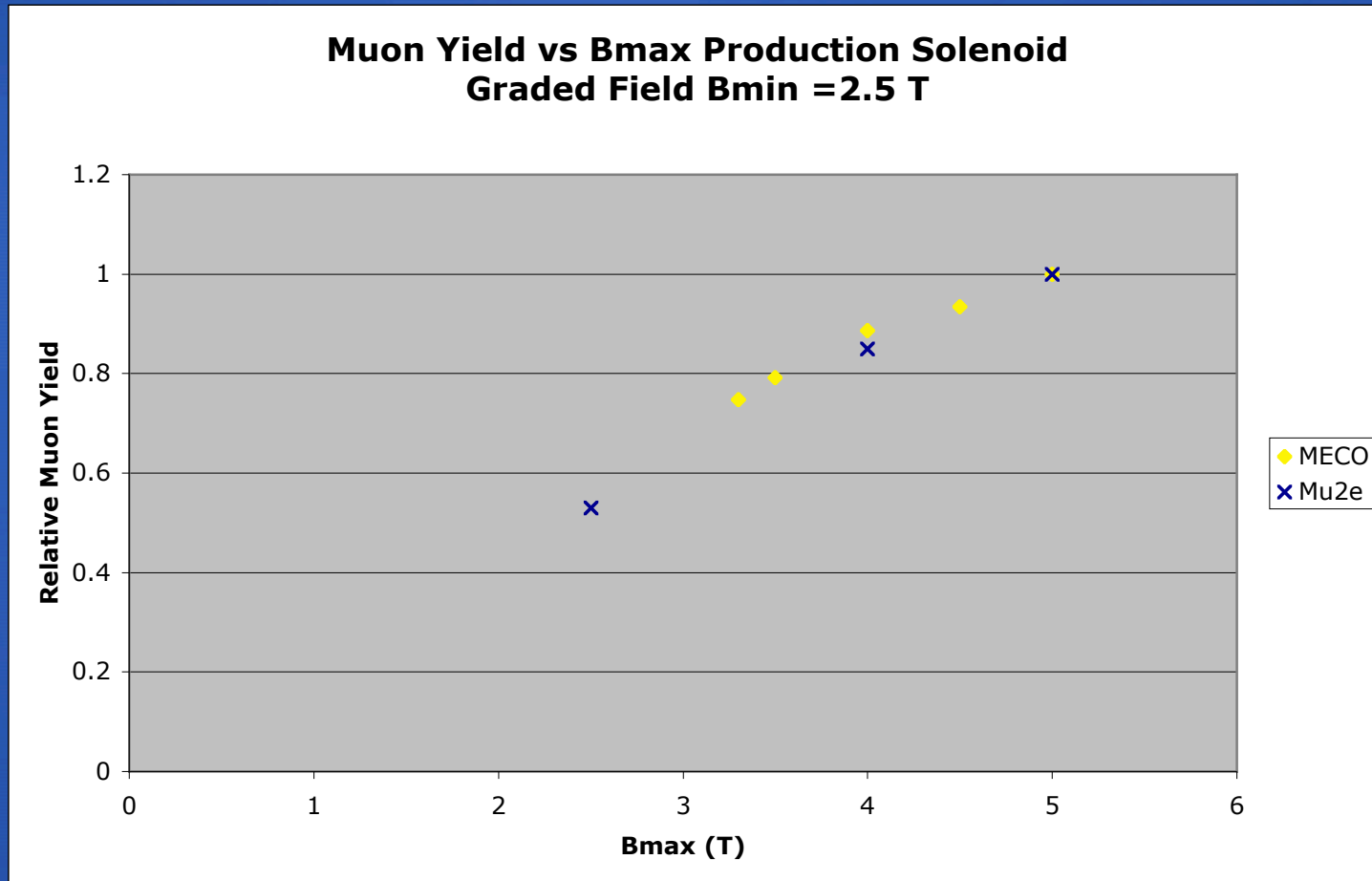

# Target z position Study (2009)

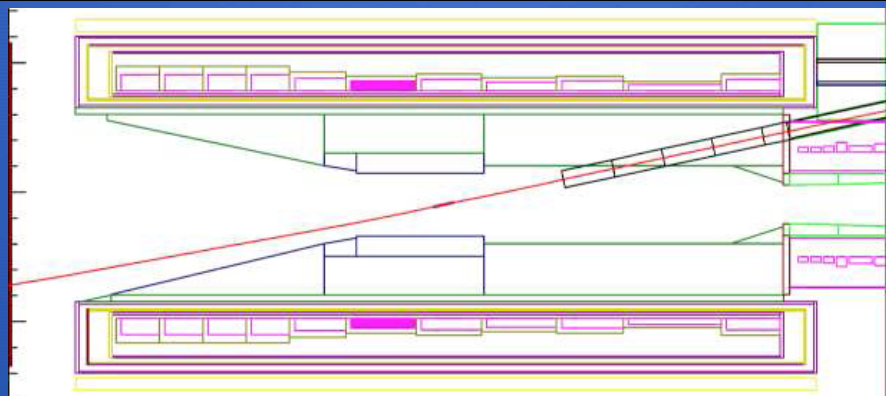
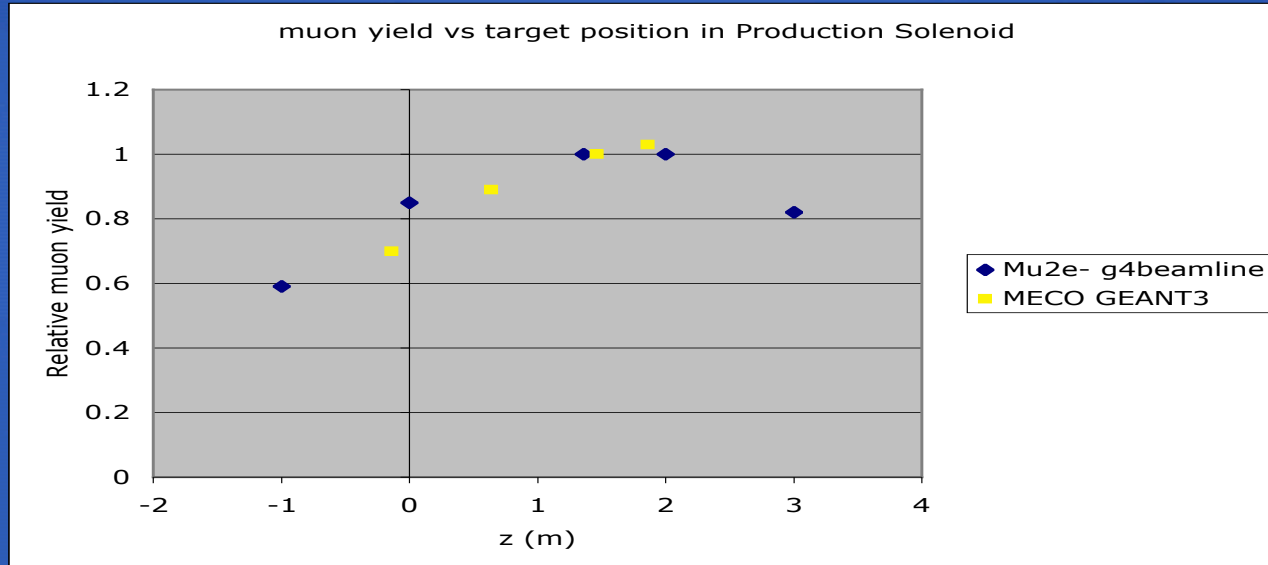

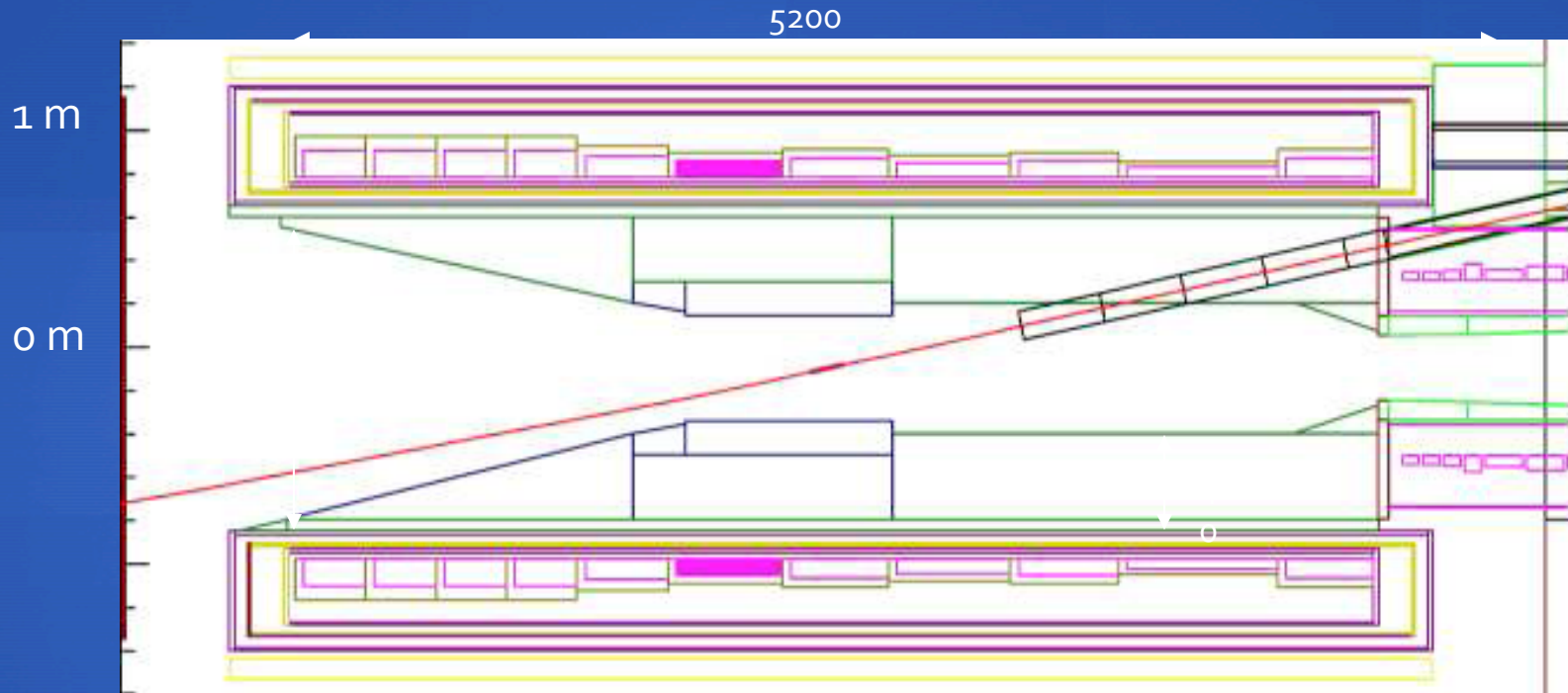

Joint Meeting in Berkeley Jan 2009  
 with COMET group- direct comparisons  
 difficult due to differing physics models

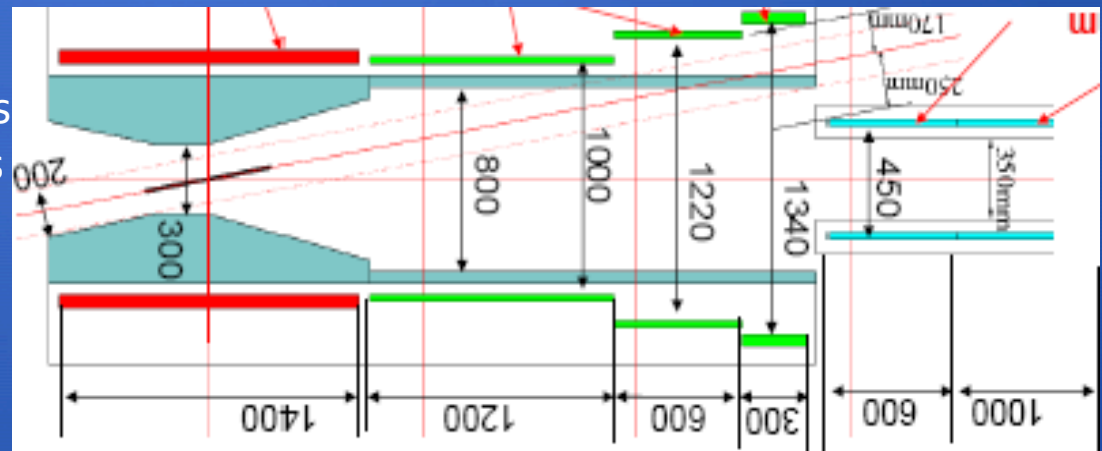
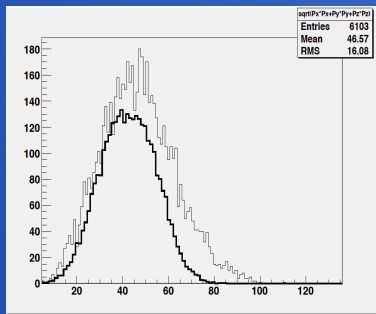



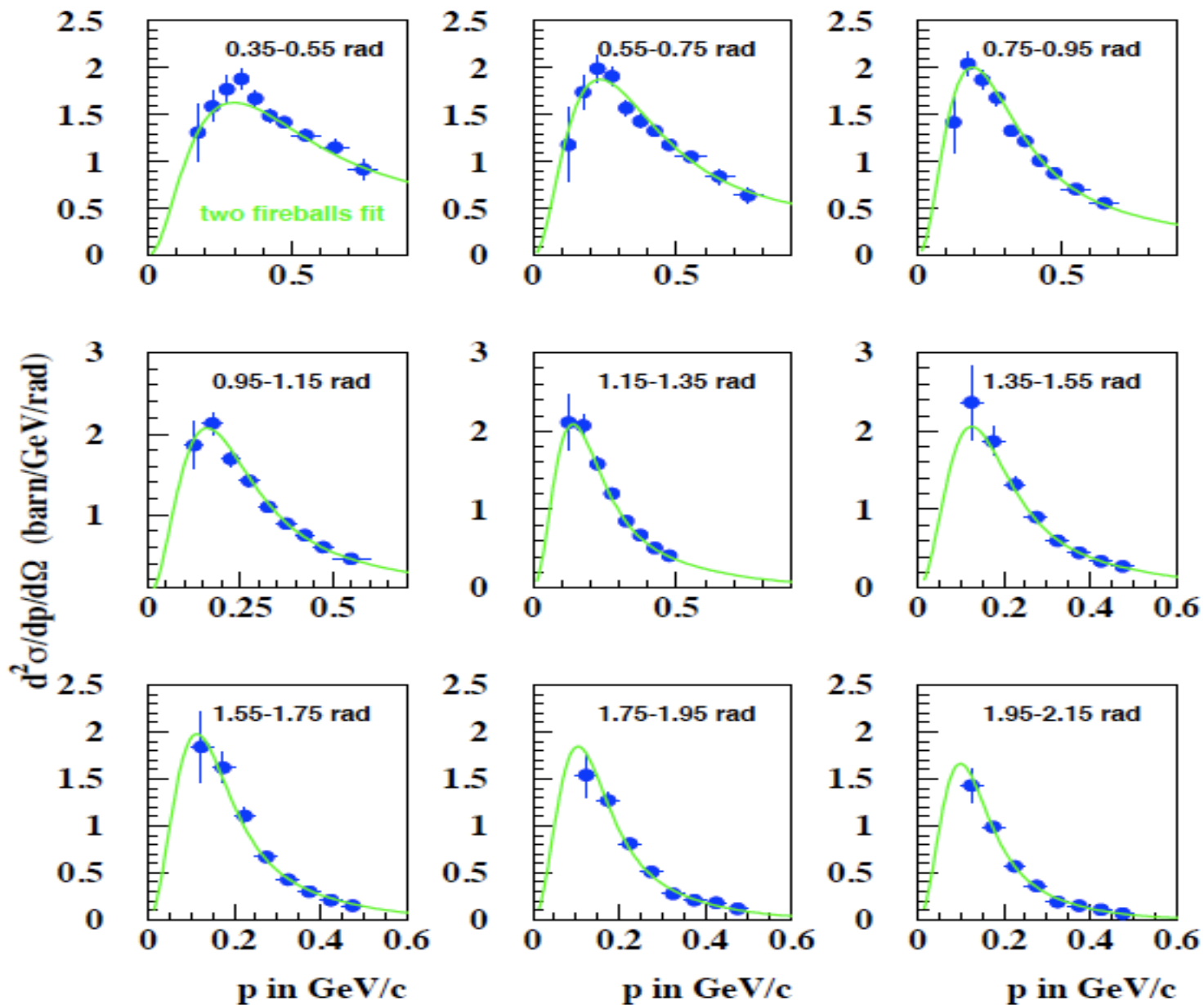

$\pi^-$  production in proton tantalum interaction at 8 GeV/c. HARP data.

Sergei Striganov improved fit for Muze 2009, similar fits by Bob Bernstein

File of pions weighted by HARP data used

# Pion Production- what energies and angles are important?

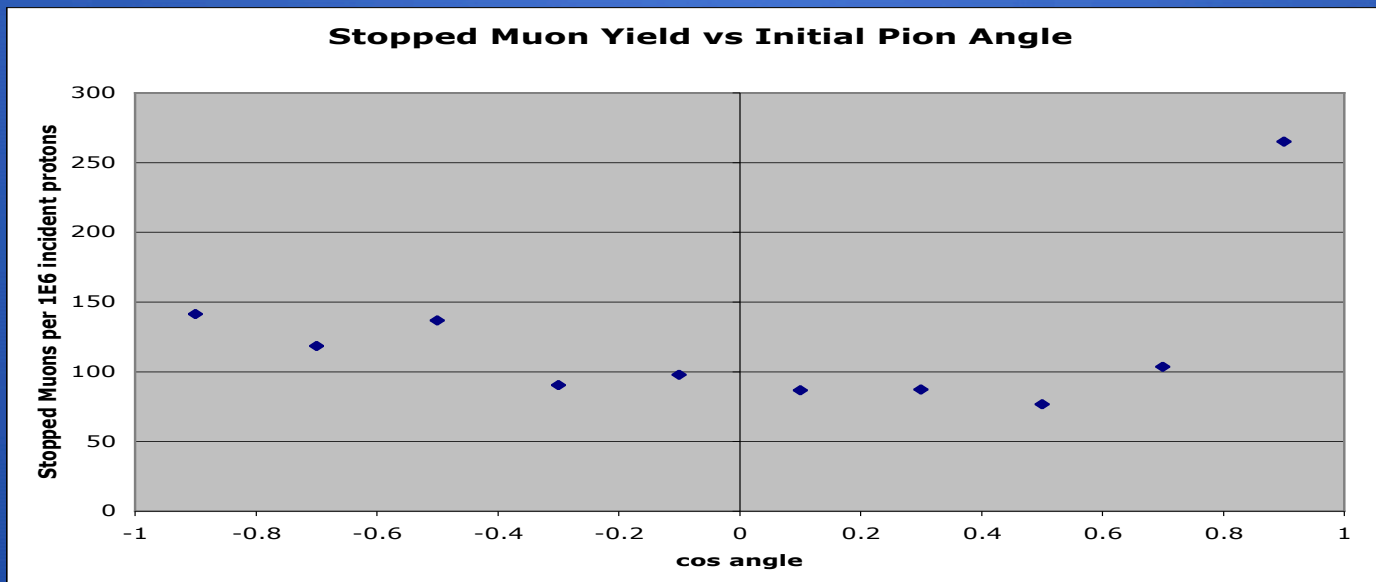
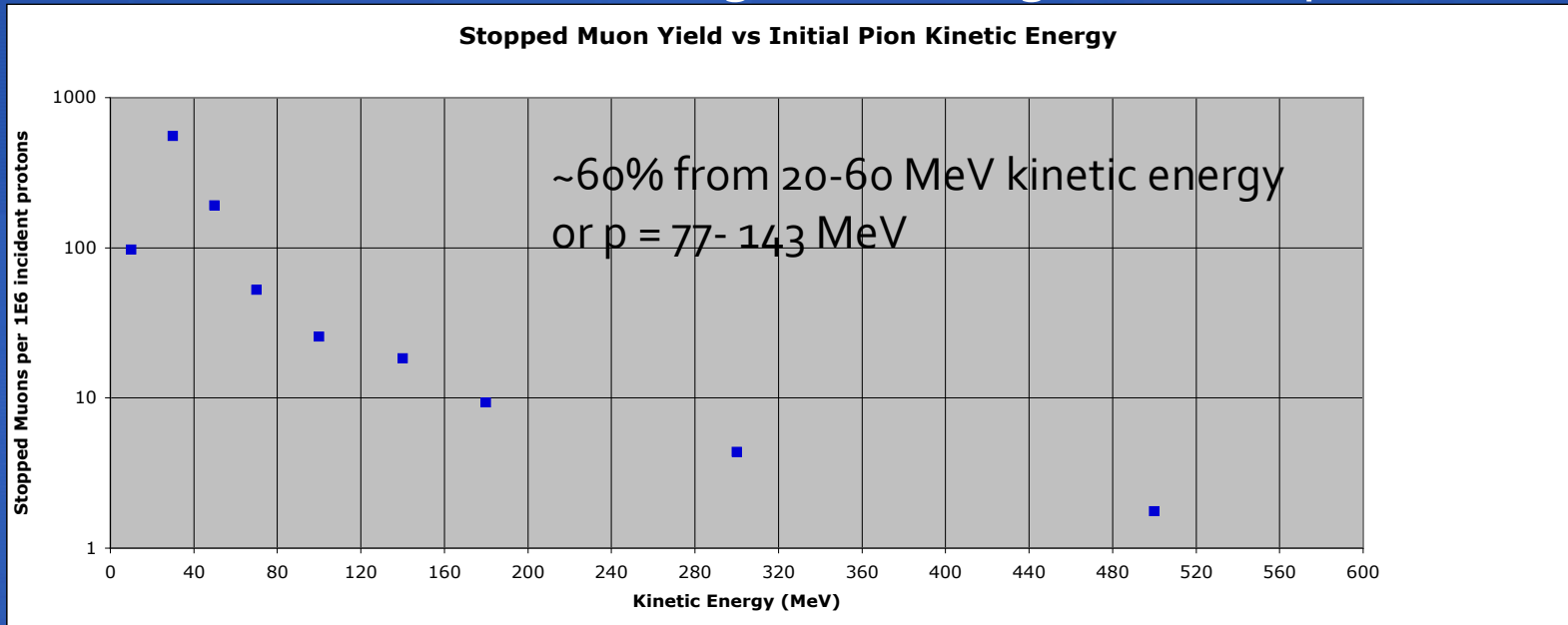

MECO

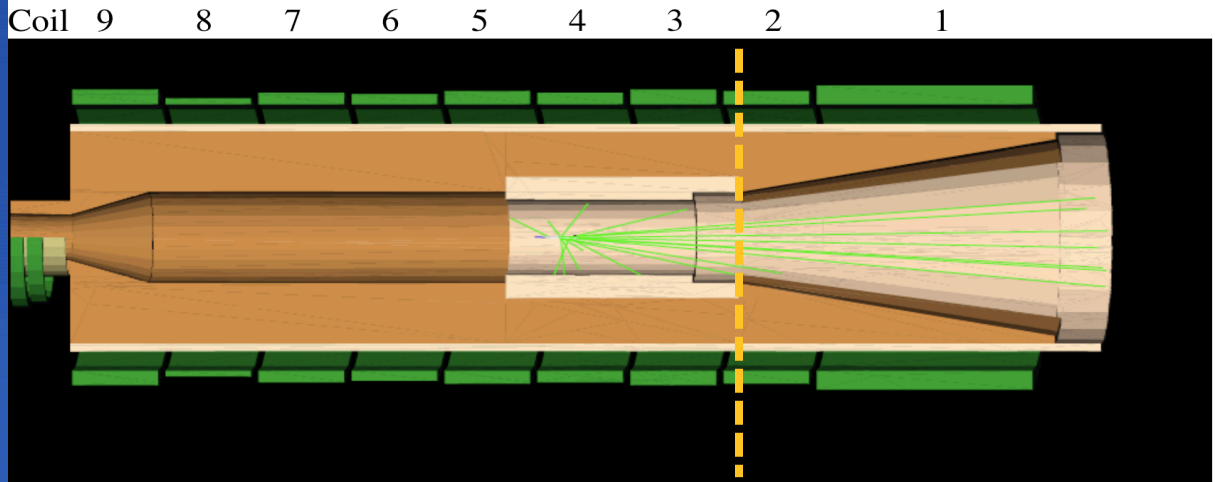

**Increase Field in Short PS from 4T to 5T max field**

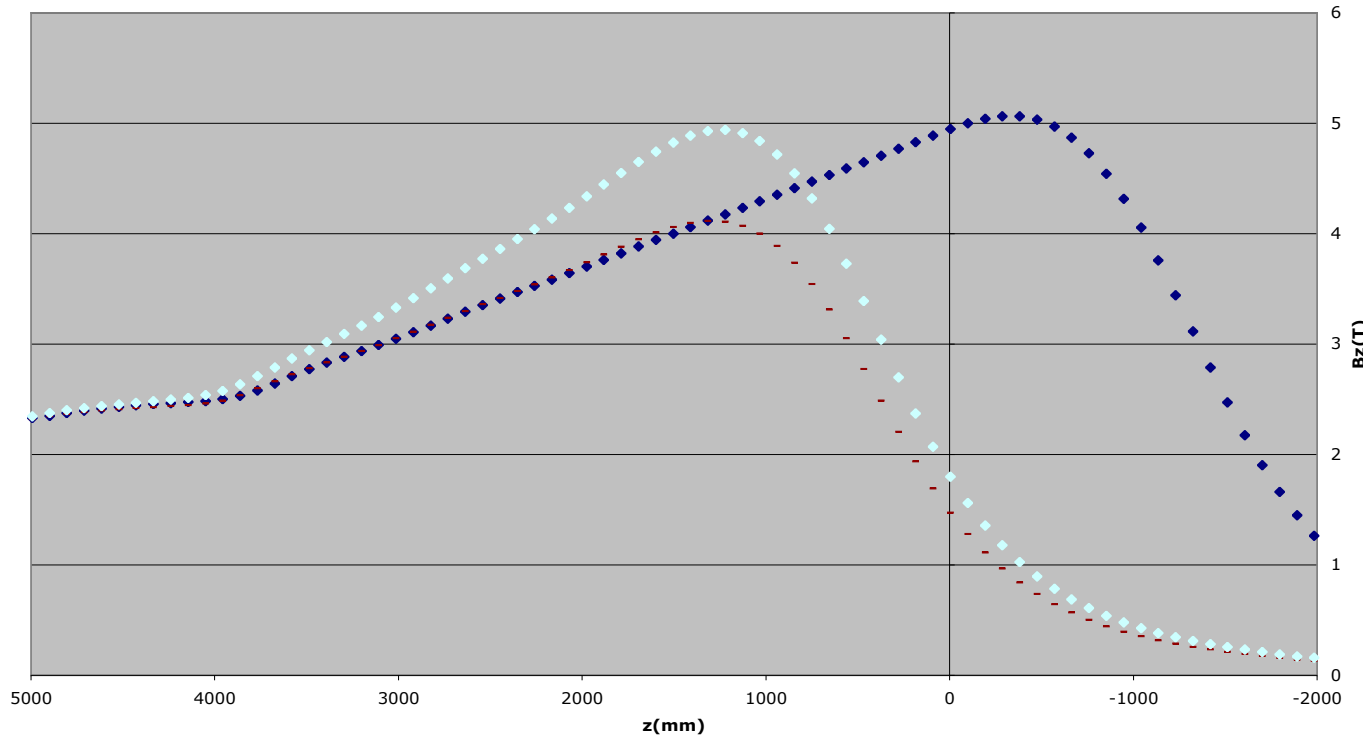

Use HARP

	Standard PS-5T max	Short PS- 4T max	Short PS- 5T max
Mu- hitting stopping target	1955	1603	1917
Mu- stopping	1280	970	1109
Relative stopped yield	=1.00	0.76	0.87

## Optimize target z position for Stopped muon yield for L= 4m Muze PS

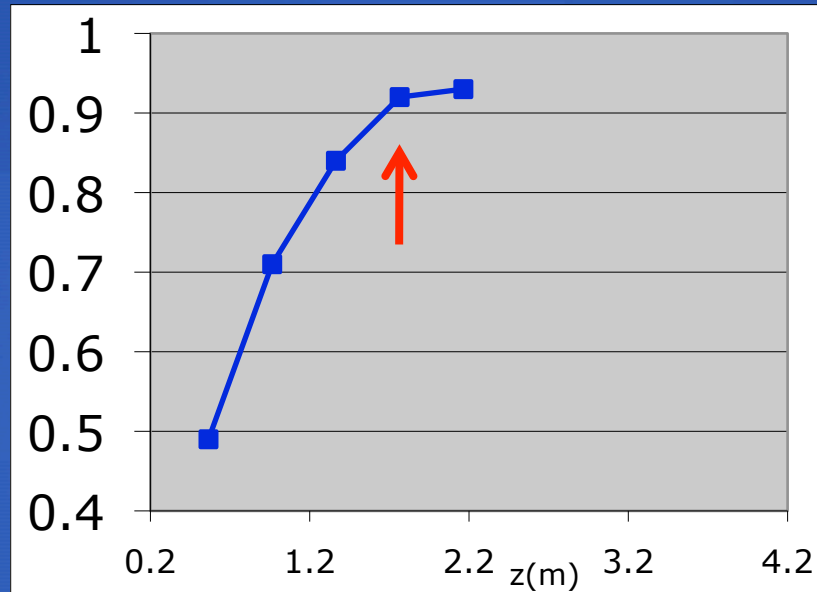

With this target location muon yield is down ~ 7% with L=4 m vs L=5.2 m (MECO)

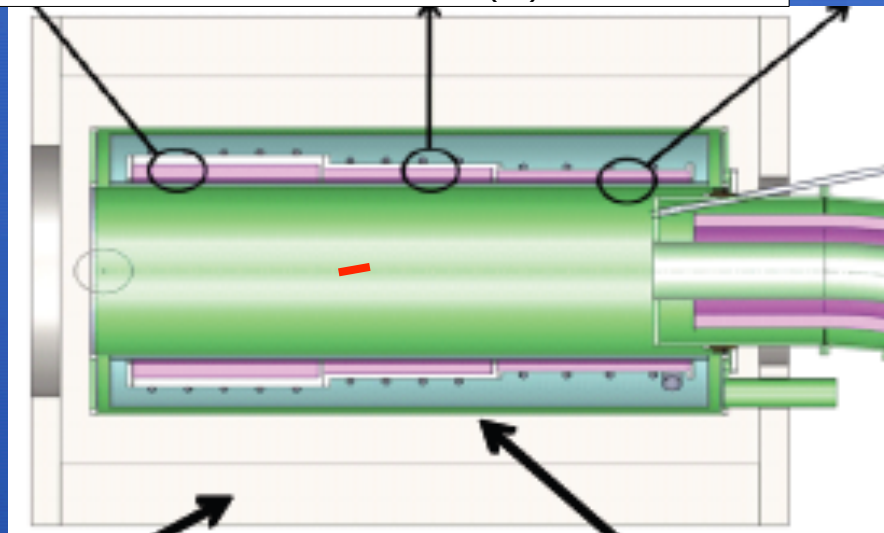

Some cost savings reducing L, but most important feature is DPA requirements can be satisfied in region where proton beam exits PS- see Vitaly's talk tomorrow

# Production Solenoid- Some Engineering Aspects – Heat Shield

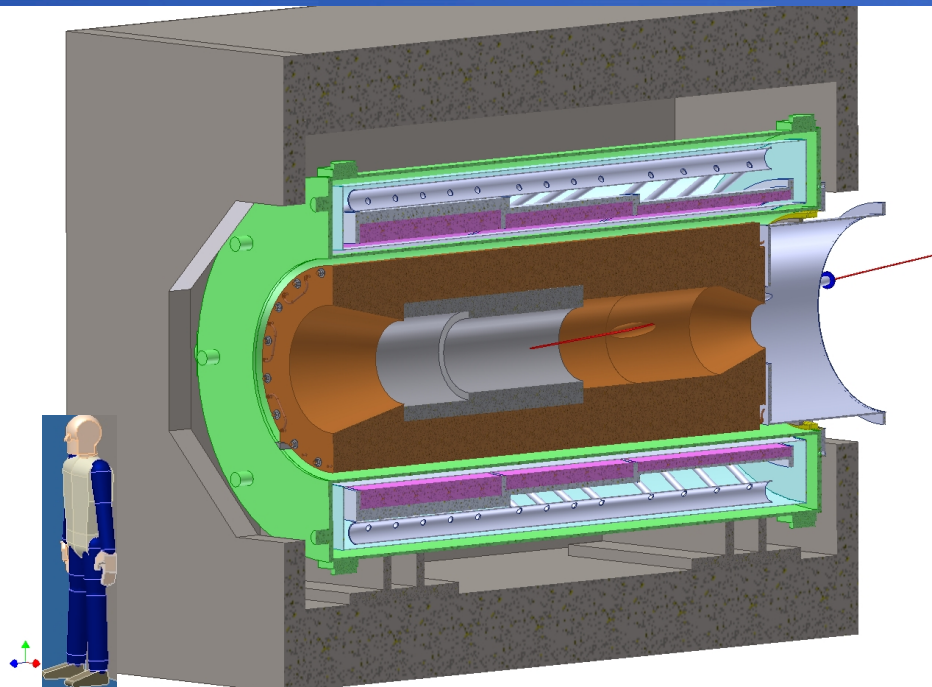

25 kW version  
Requires Tungsten → \$\$\$  
Heat Transfer issues

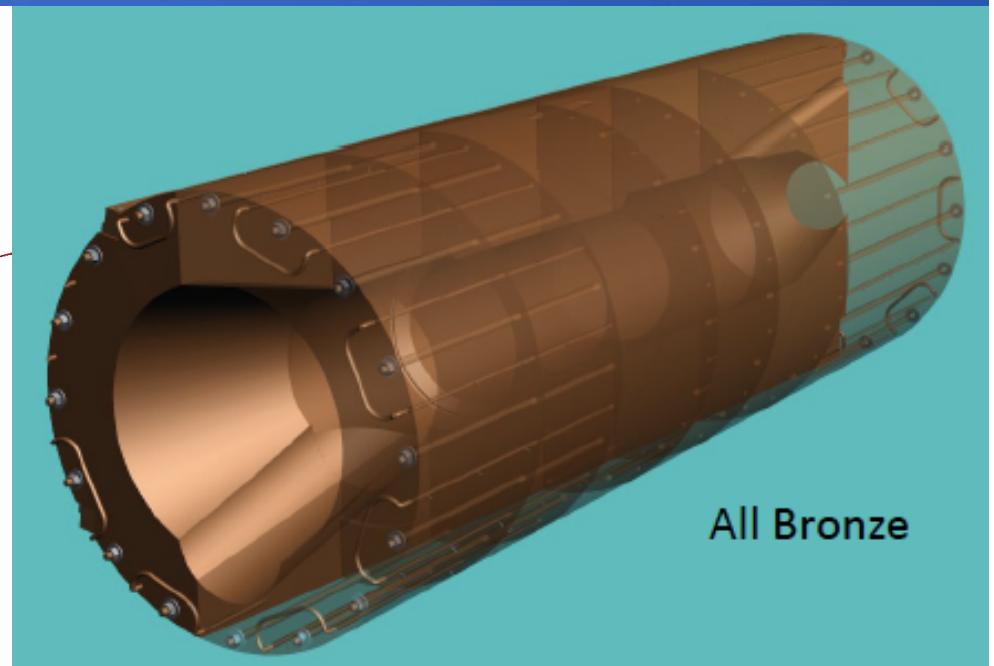

8.3 kW current version

# The Muze All-Bronze Heat and Radiation Shield Design

Exploded view showing radiation labyrinths and all parts

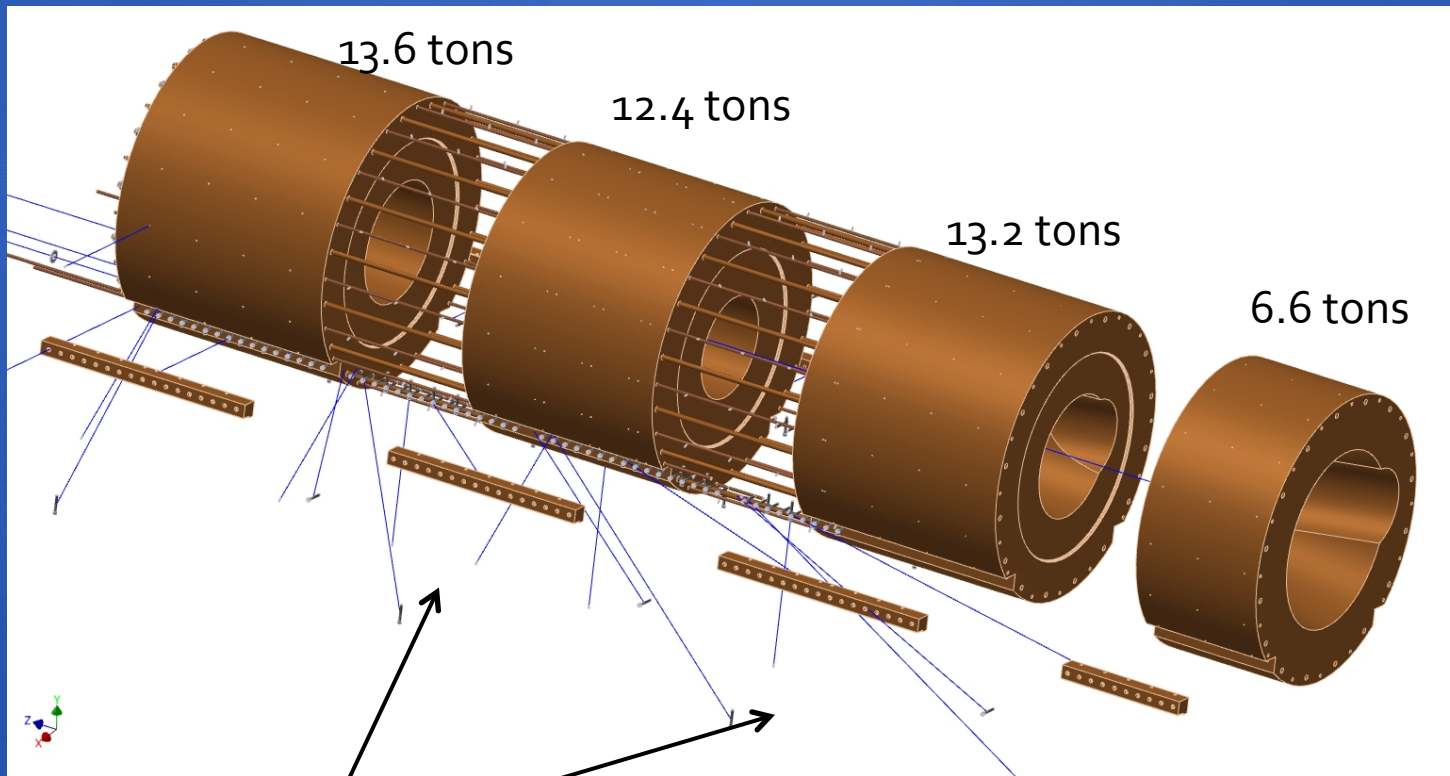

Bolt-on rails

46 tons total

L. Bartoszek

# Status of Heat Shield Engineering

- We have to build drawings on all-bronze 8.3 kW
- 3 cost estimates, very consistent, significant savings in 8.3 kW version over 25 kW version which uses tungsten
- Thermal analysis in progress, not expected to be a problem
- Need to explore other materials (Copper, Copper/Nickel)
- Continue simulations to optimize design

# Backup Slides

---





## 2 Batch Spill Structure Mu2e Part of Timeline

### 2 Batch Scenario

Timing of proton extractions from the Recycler Ring (RR) to the Debuncher Ring (Deb.)

- 8 spills for each 1.33sec super-cycle (20 ticks)
- Spill length: 53.81 ms
- 10 msec gap between spills
- $38.7 \times 10^6$  protons/ $\mu$ -pulse
- After last spill: no beam for 912.9 ms

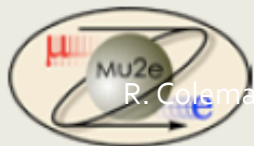
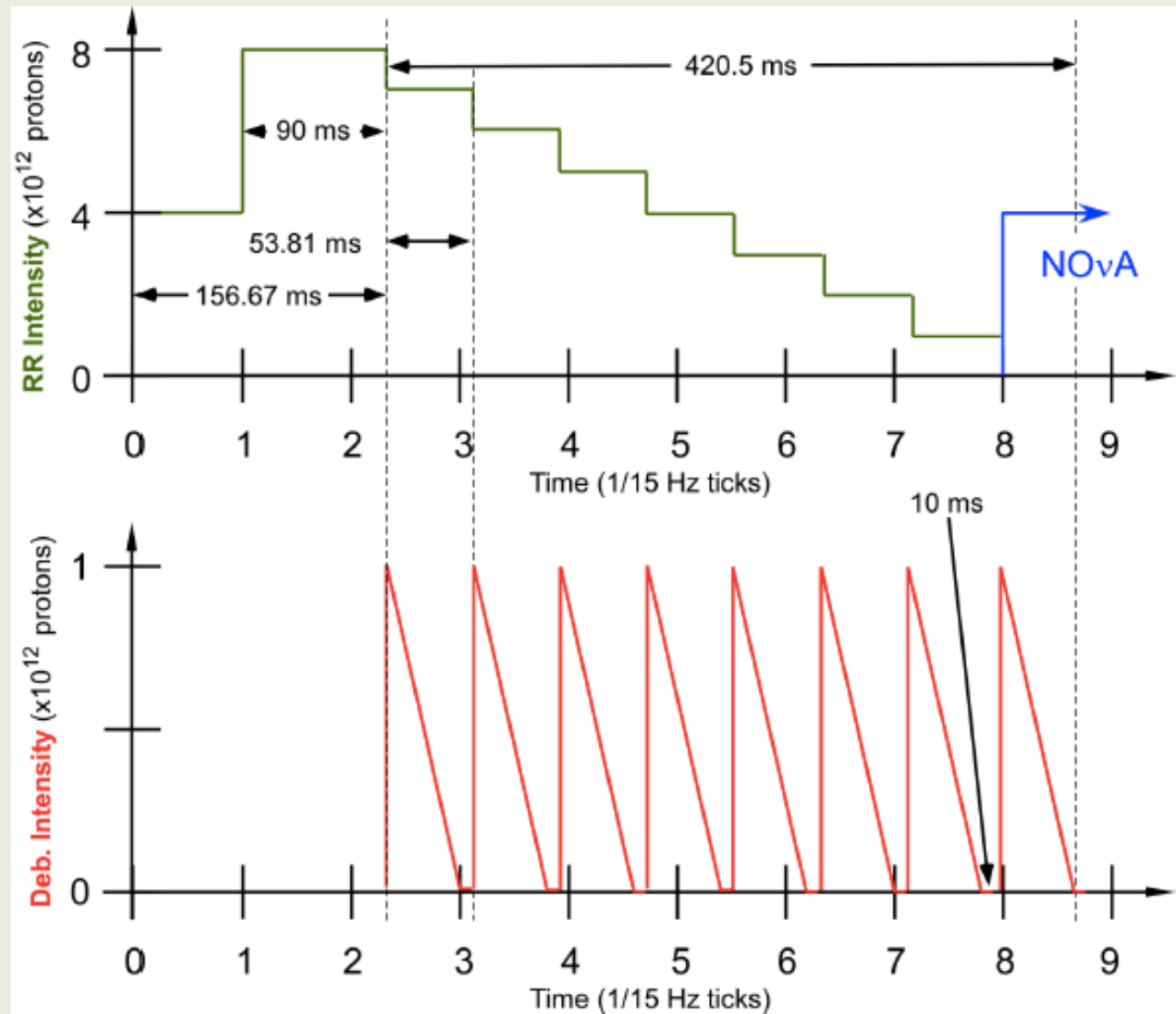



# History of CLFV Searches

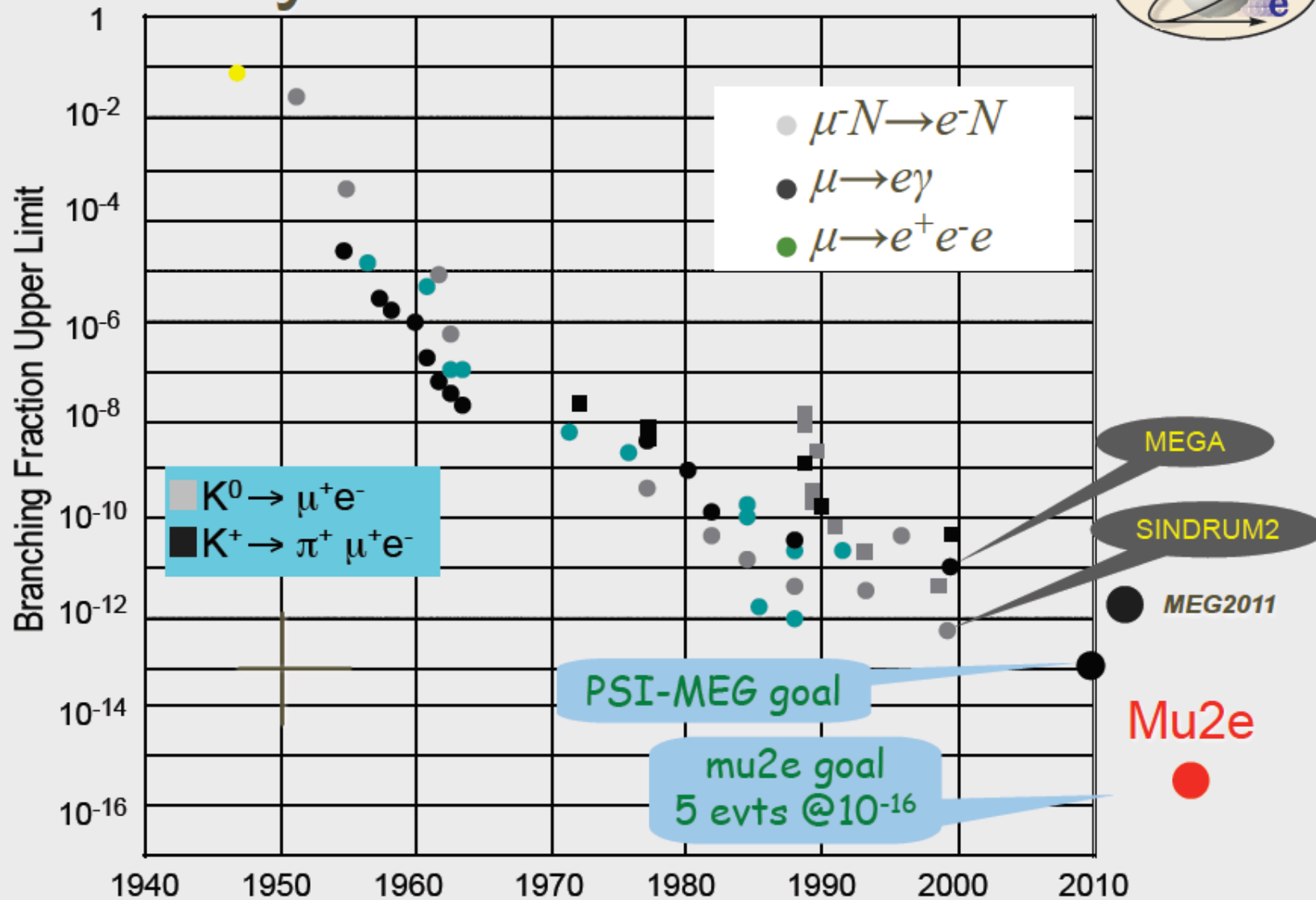

MEG 2011: arXiv:1107.5547 [hep-ex]

R. Bernstein, FNAL

8

Mu2e

SLAC 9/8/2011

# Electron Flash and Middle-Collimator

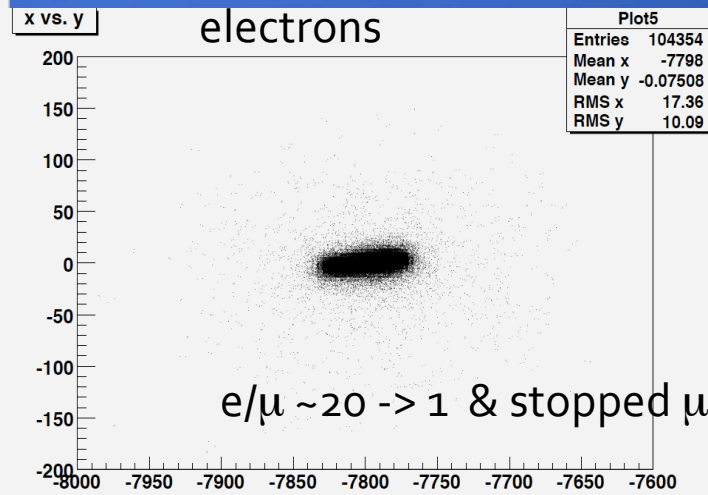
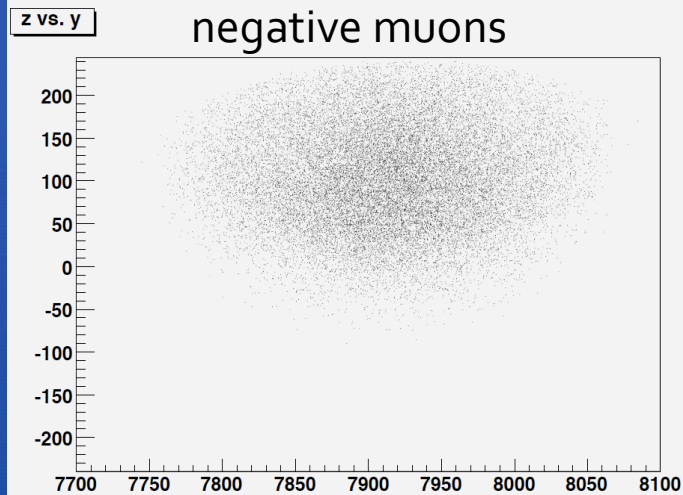
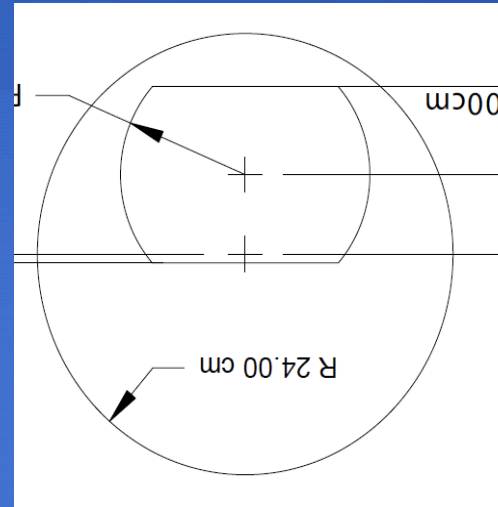
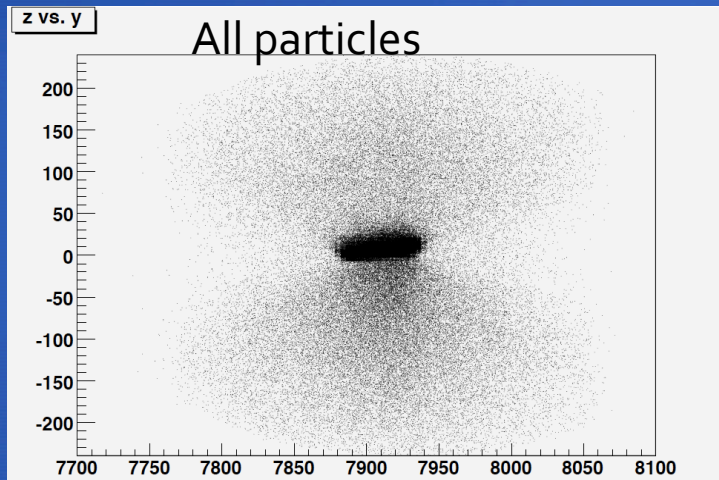

# $e^-/\mu^-$ flux entering the Detector Solenoid

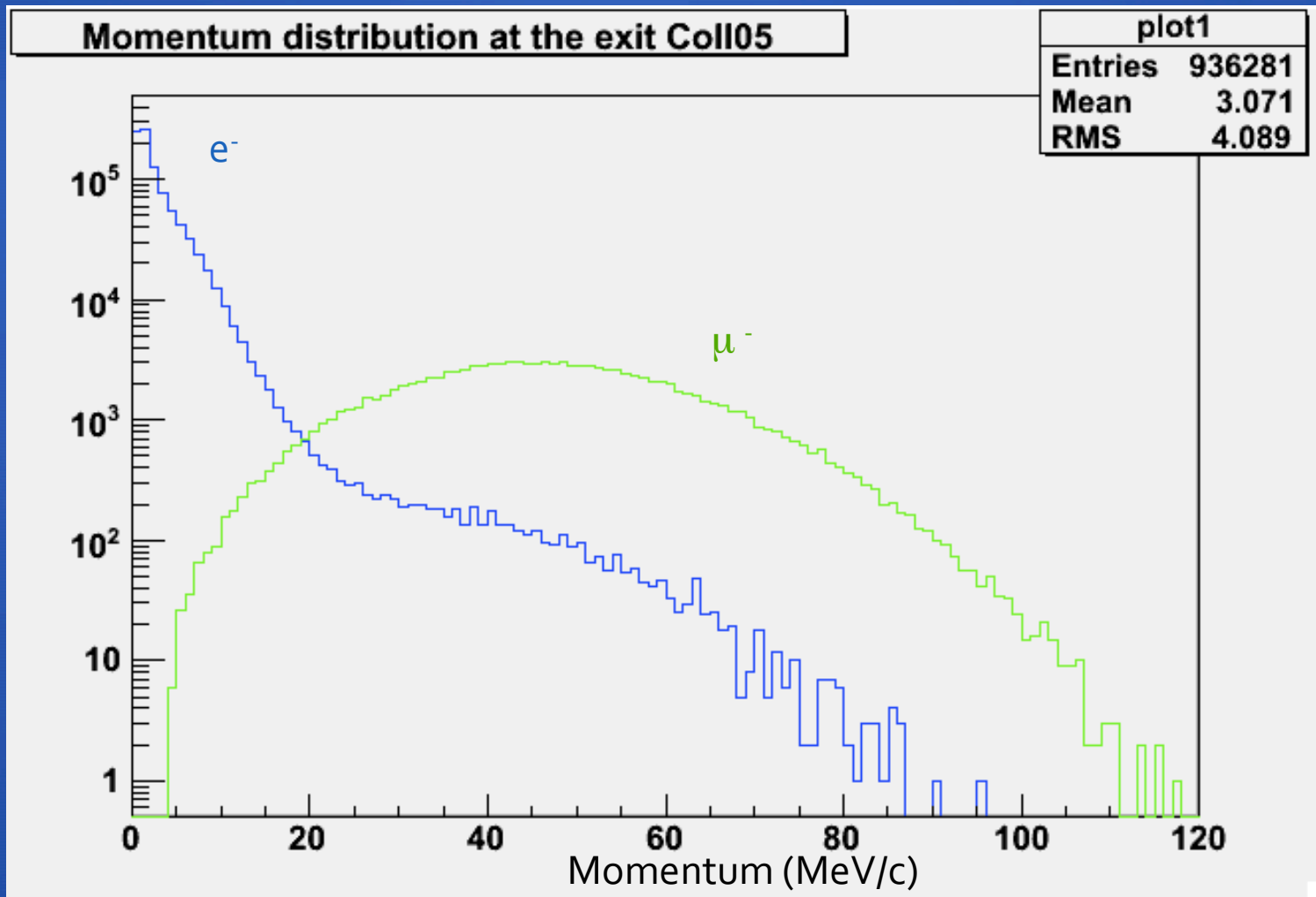

# Time distribution entering Detector Solenoid

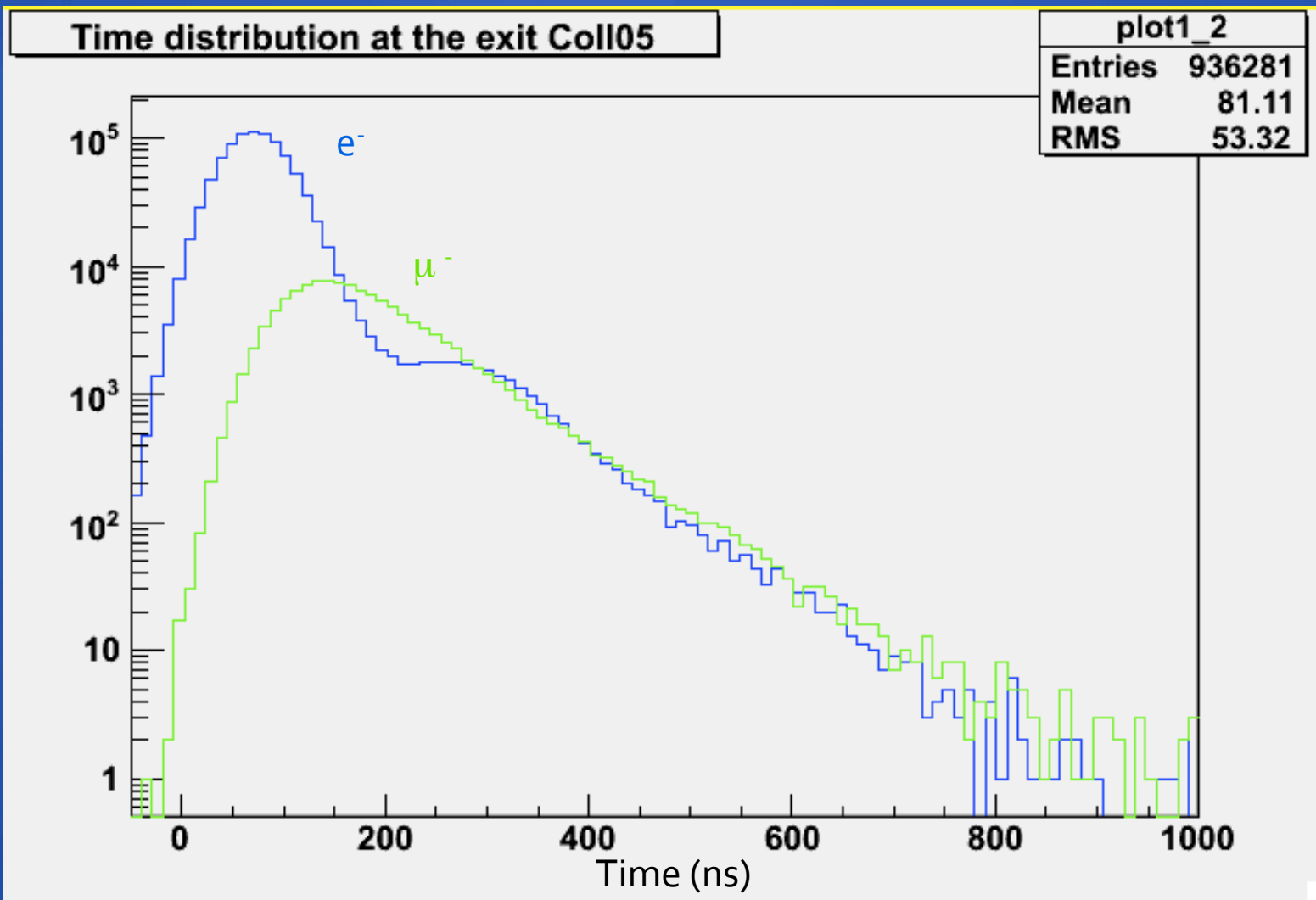

# Time vs p - negative muons reaching stopping target

MECO PS

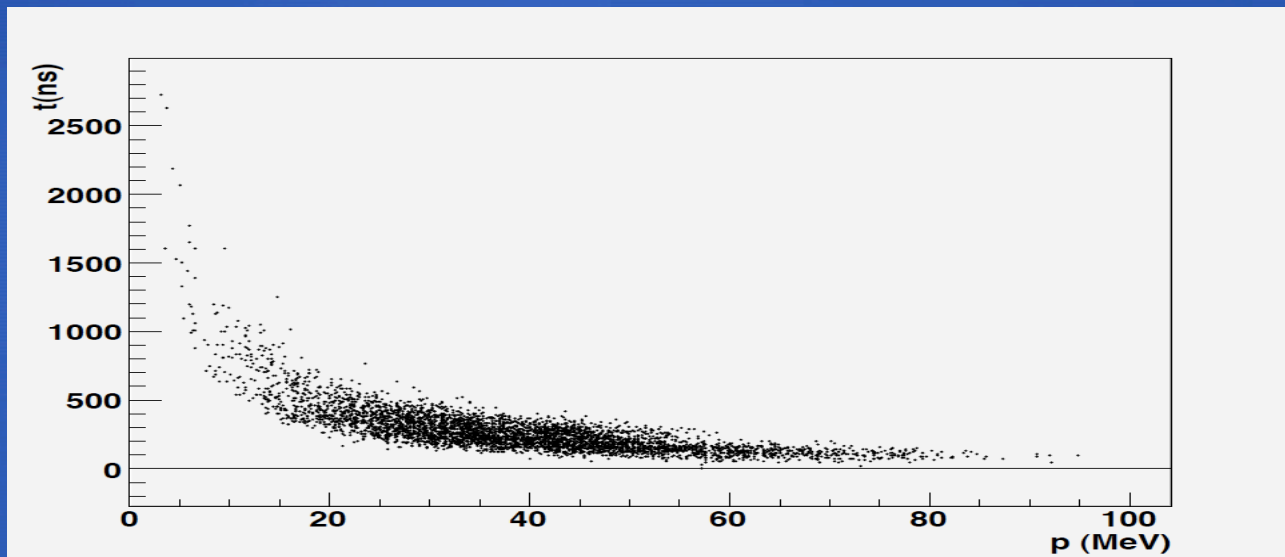

Muze PS

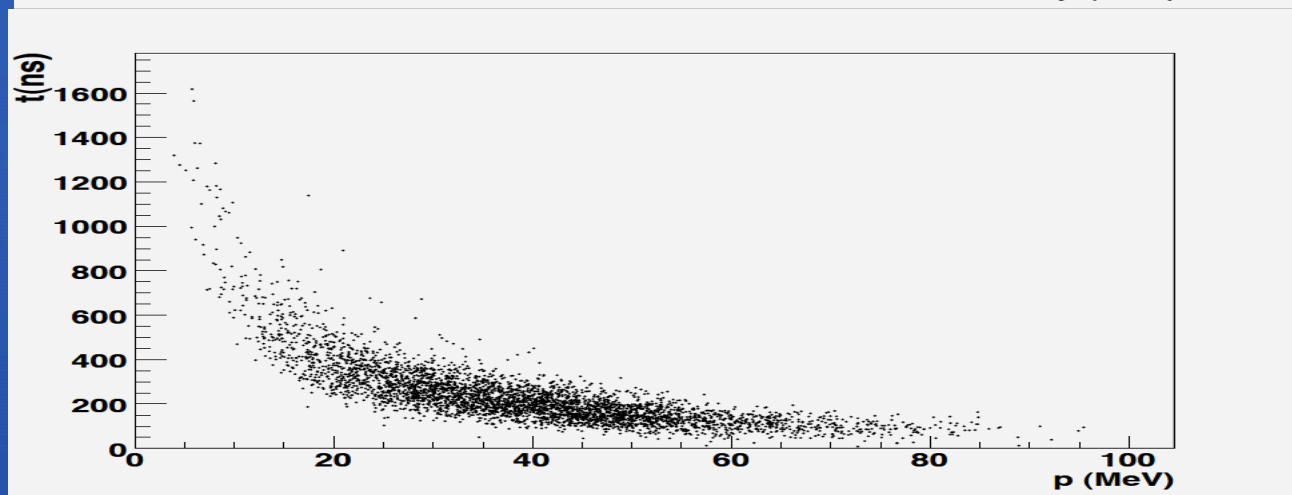

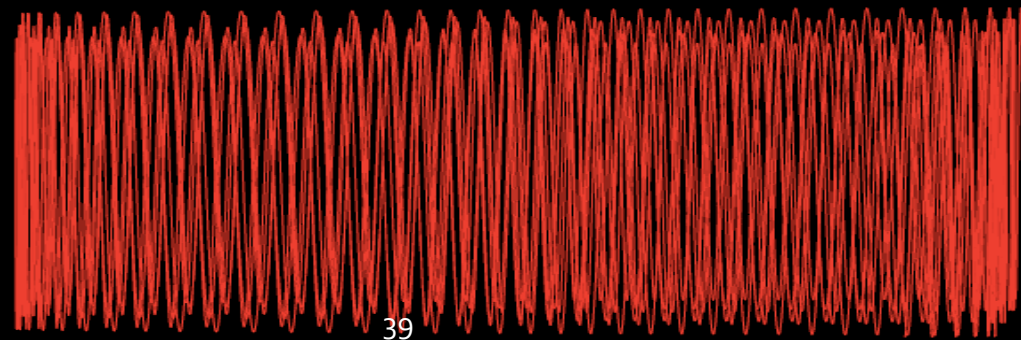
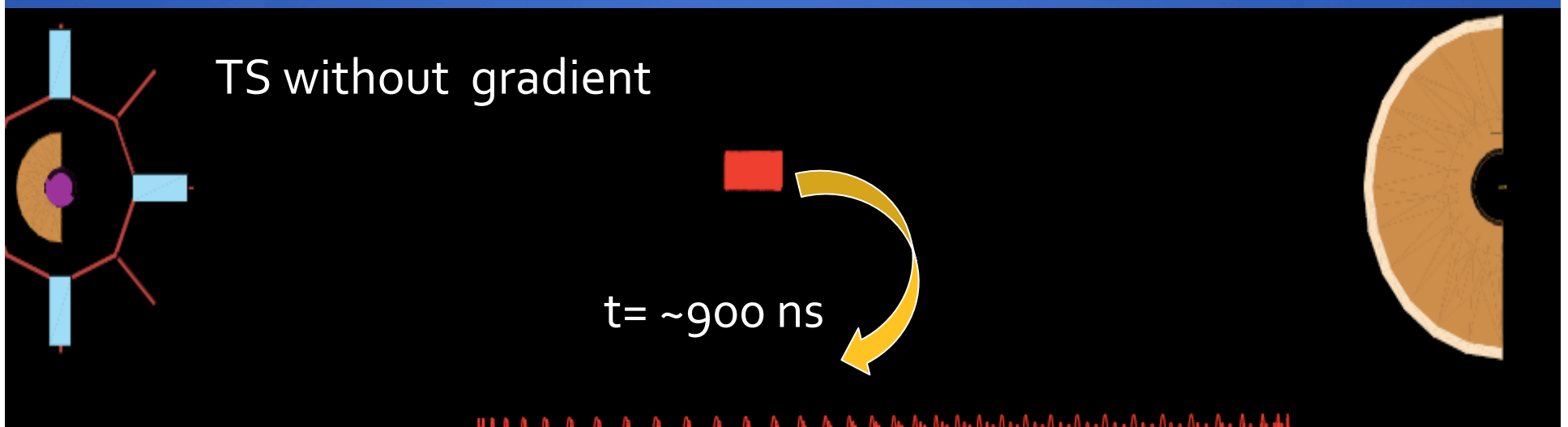
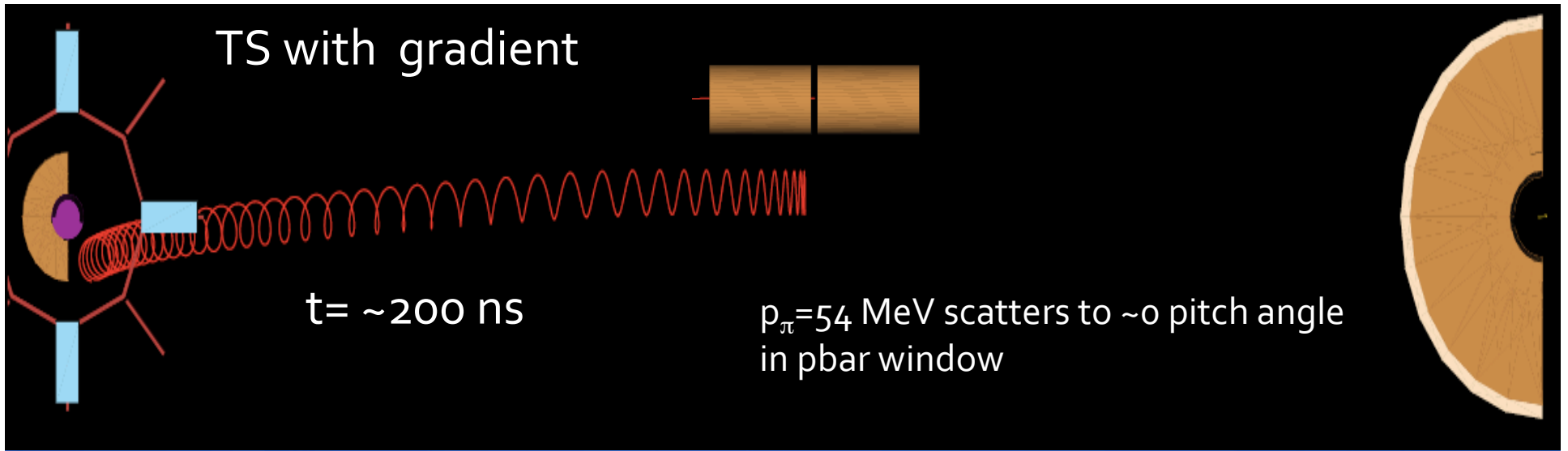

# Study of the Production Solenoid Gradient vs Muon Yield

Fig 4 Bz(T) vs z for Mu2e(blue) and an alternative shapes(A1-A4)

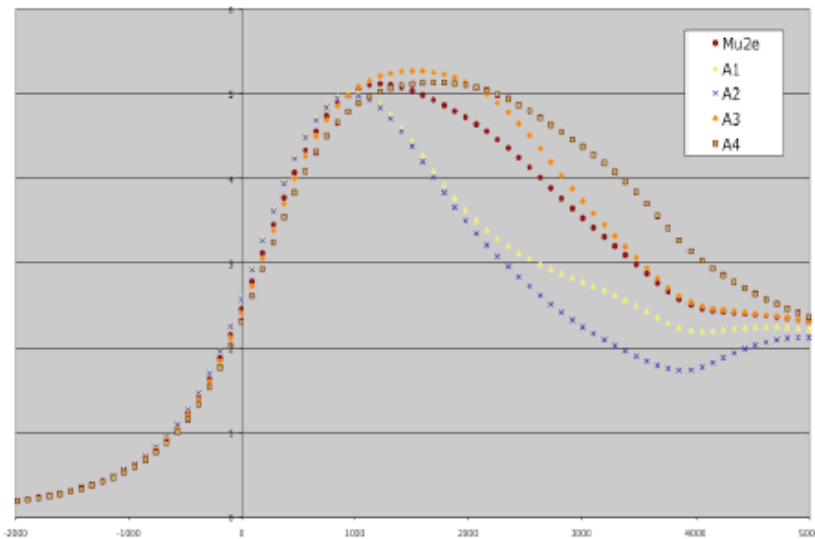

Fig 18 Bz(T) vs z for Mu2e(blue) and an alternative shapes(A5-A?)

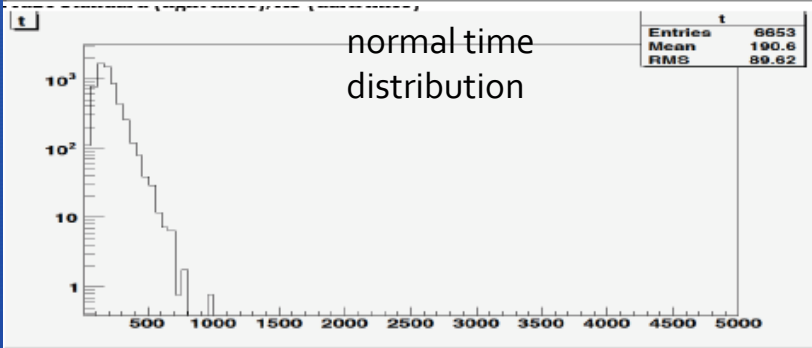
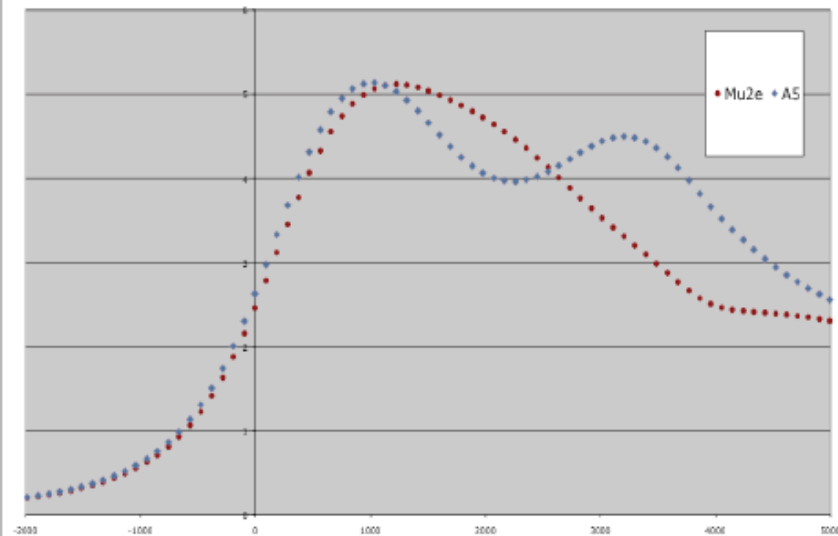

Fig 20 Distribution of Time (ns) for muons passing the last collimator Mu2e Standard (light lines)

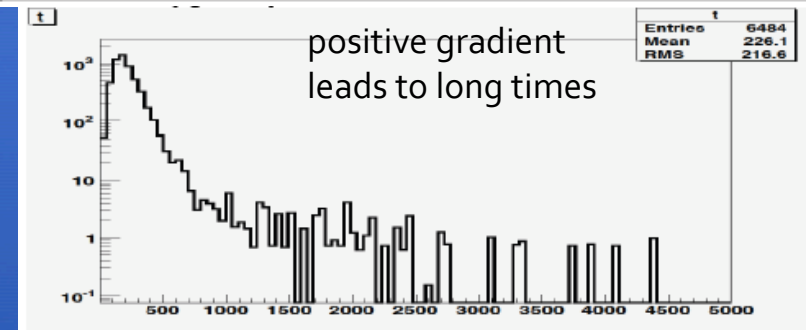

Fig 21 Distribution of Time (ns) for muons passing the last collimator A5 (dark lines)



<b>Background</b>	<b>Background Estimate</b>	<b>Error Estimate</b>	<b>Reference</b>	<b>Justification</b>
Radiative Pion Capture	0.04	$\pm 0.02$	1087	Acceptance and energy loss modeling
Muon decay in orbit	0.009	$\pm 0.006$	387	Acceptance and energy loss modeling and spectrum calculation
Cosmic Rays	0.025	$\pm 0.025$	CDR	2 event statistics
Pion decay In-Flight	0.003	$\pm 0.0015$	1175	Cross-section, acceptance and modeling
Muon decay In-Flight	0.034	$\pm 0.017$	1175	Cross-section, acceptance and modeling
Antiproton Induced	0.06	$\pm 0.06$	1366	Cross-section, acceptance and modeling
Beam electrons	0.0006	$\pm 0.0003$	1367	Cross-section and acceptance (and this is an upper limit)
Radiative muon capture	$< 2 \times 10^{-6}$	–	1230	Calculation
Reconstruction Errors	$< 0.002$	$\pm 0.002$	CDR	Not all sources of tracker activity evaluated yet.
<b>Total</b>	<b>0.17</b>	<b><math>\pm 0.07</math></b>	<b>1087</b>	<b>Add in quadrature</b>

Table 3.1. Summary of background estimates and errors.

