



MIT Testing Results

V.B. Graves

MUTAC Review

Brookhaven National Laboratory

April 18, 2007

OAK RIDGE NATIONAL LABORATORY
U. S. DEPARTMENT OF ENERGY

High Field Pulsed Solenoid

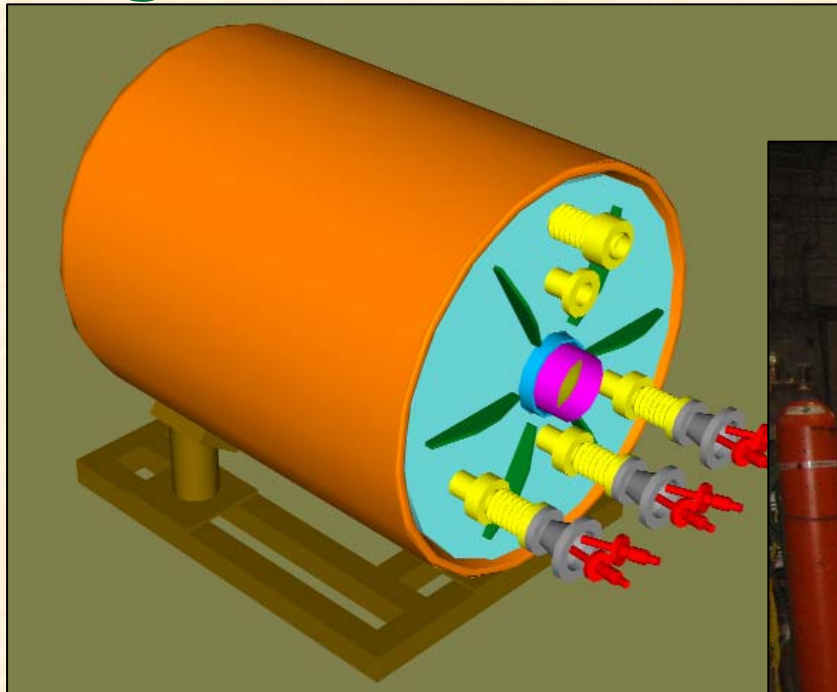

- 80K Operation
- 15T with 5.5 MVA pulsed power
- 15 cm warm bore
- 1 m long beam pipe
- 15T reached at MIT March 2006

Peter Titus, MIT

OAK RIDGE NATIONAL LABORATORY
U. S. DEPARTMENT OF ENERGY

Hg System Equipment



- Syringe pump
- Hydraulic power unit w/control system
- Optical diagnostic system
- Baseplate support structures



OAK RIDGE NATIONAL LABORATORY
U. S. DEPARTMENT OF ENERGY

MUTAC Review BNL 18 Apr 2007

UT-BATTELLE

MERIT Side View

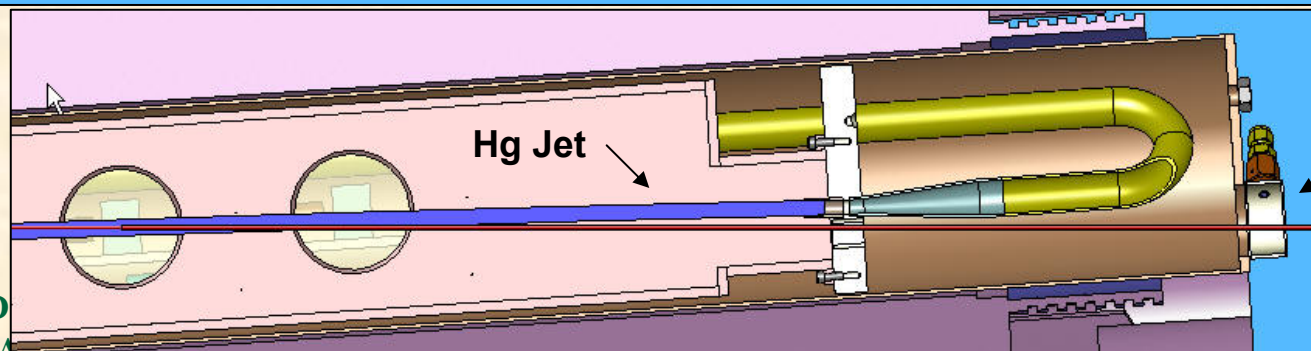
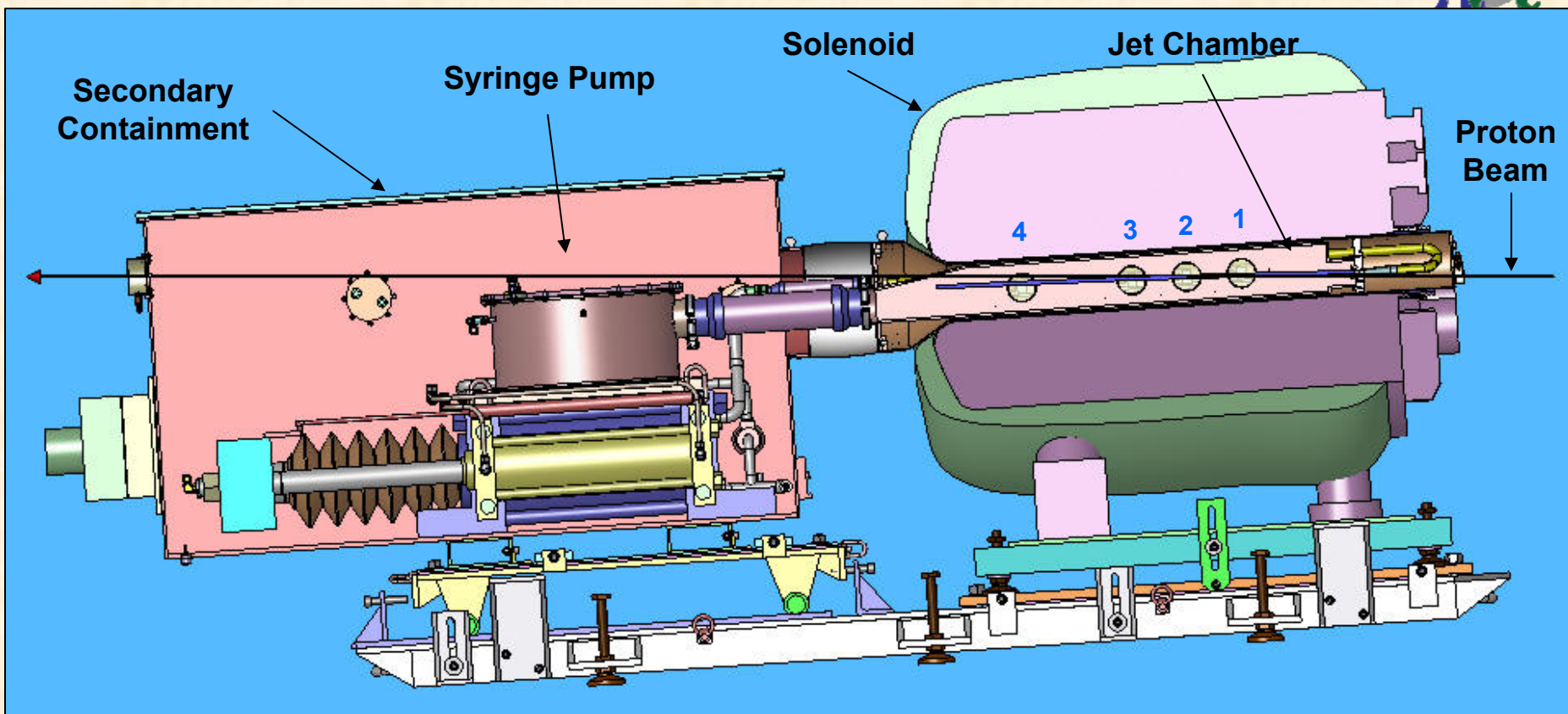

Hg System Schematic

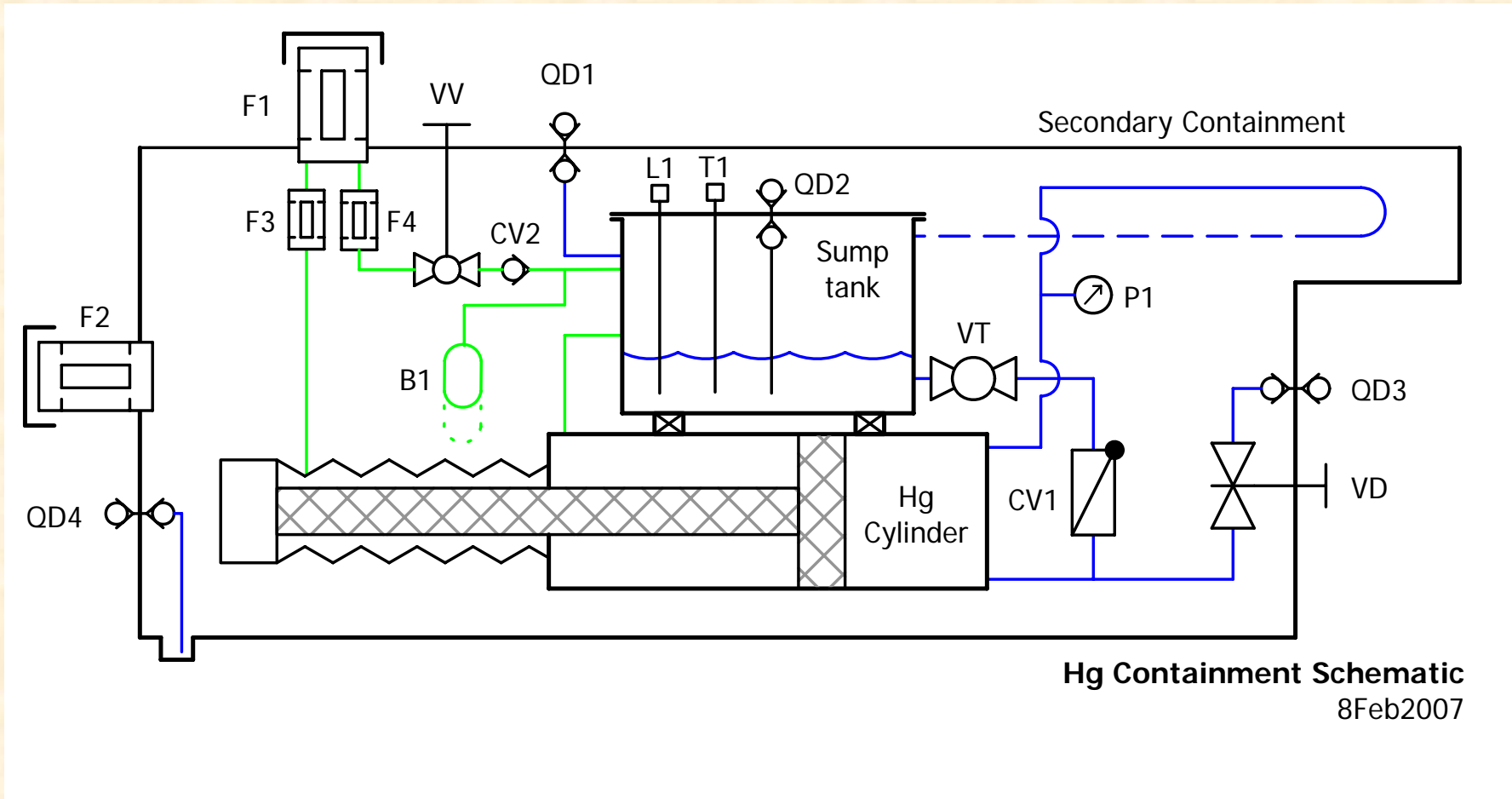

Optical Diagnostic Tool: High-Speed Camera to Fast Record Transient Phenomena



- Back-illuminated laser shadow photography technique
- Freeze the image of events using high speed camera (up to 1 μ s/frame)
- Synchronized arrival of short laser light pulses illuminate onto the target
- The motion of the target after proton impact is frozen by high intensity short (150 ns) laser pulses
- 2-dimensional image



Optical Diagnostics in Secondary Containment

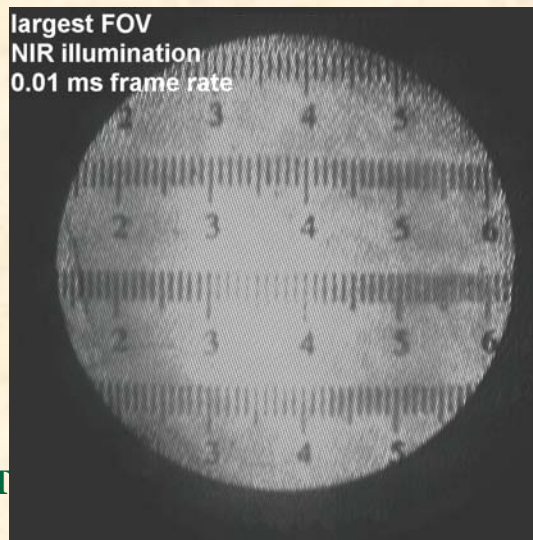
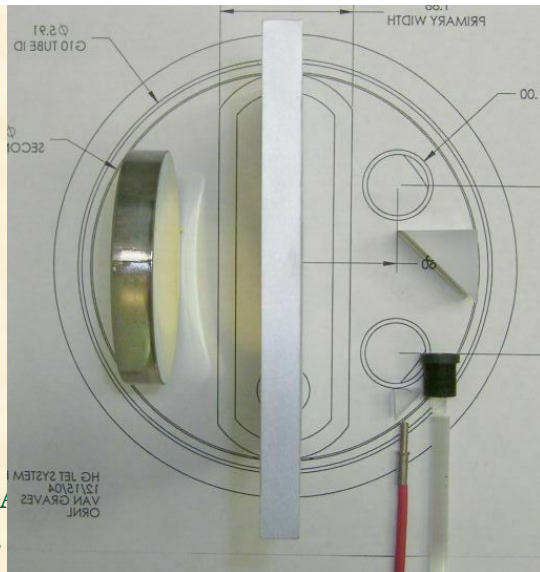
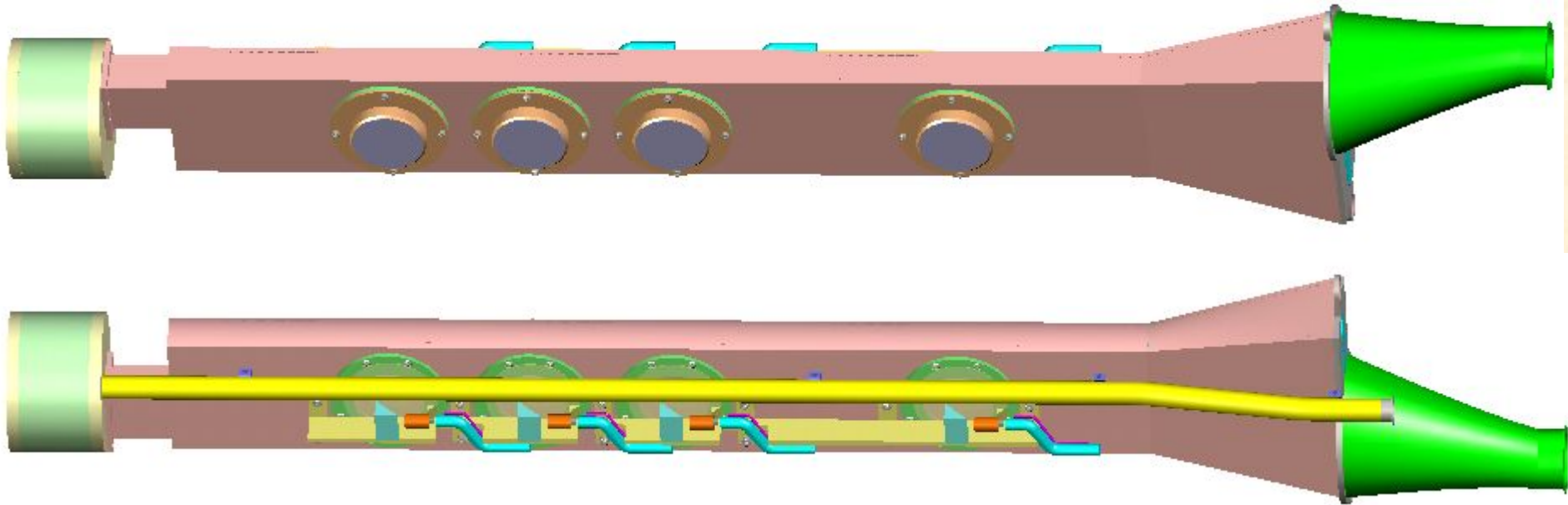

One set of optics per viewport

T.Tsang, BNL



1st Hg jet runs with 15T magnet on March 3, 2007 @ MIT

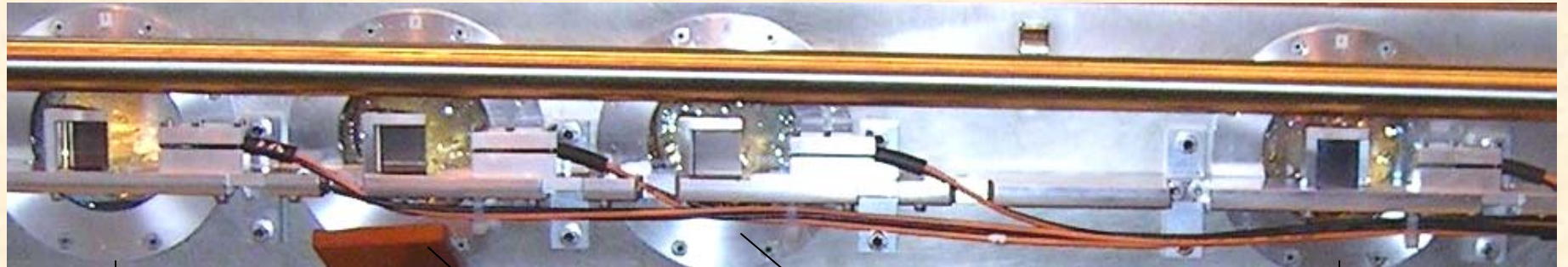

FastVision 1



SMD

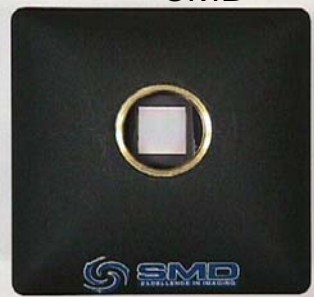

FastVision 2



video camera

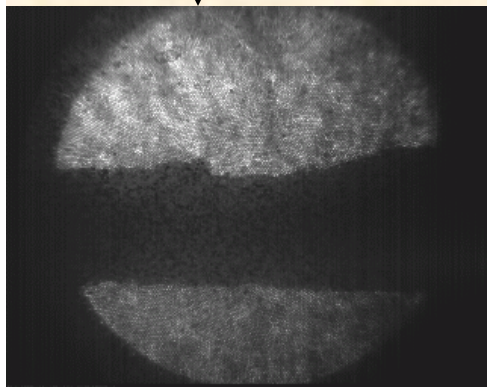

2 ms/frame

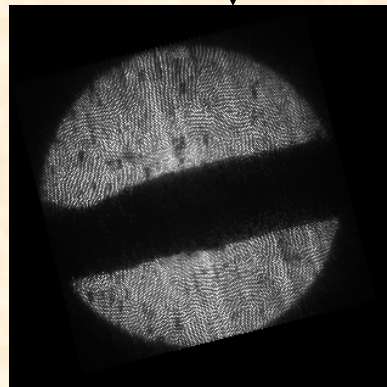

0.1 ms/frame

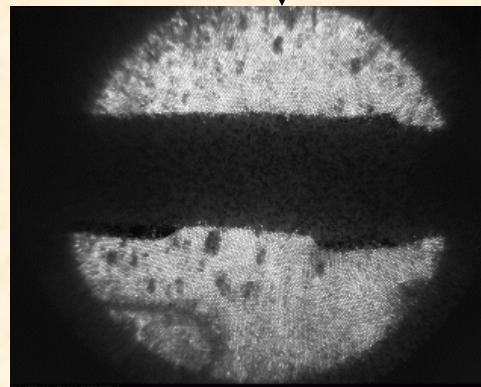

2 ms/frame



30 frames/s

20 m/s Hg jet, 7 Tesla magnetic field

all images have a horizontal flip

Syringe Pump System

- **Primary containment**
 - Hg-wetted components
 - Capacity 23liters Hg (~760 lbs)
 - Jet duration up to 12 sec
- **Secondary containment**
 - Hg leak/vapor containment
 - Ports for instruments, Hg fill/drain, hydraulics
- **Optical diagnostic components**
 - Passive optics
 - Shadow photography
- **Beam Windows**
 - Ti alloy components that directly interact with beam
 - Single windows on primary, double windows on secondary

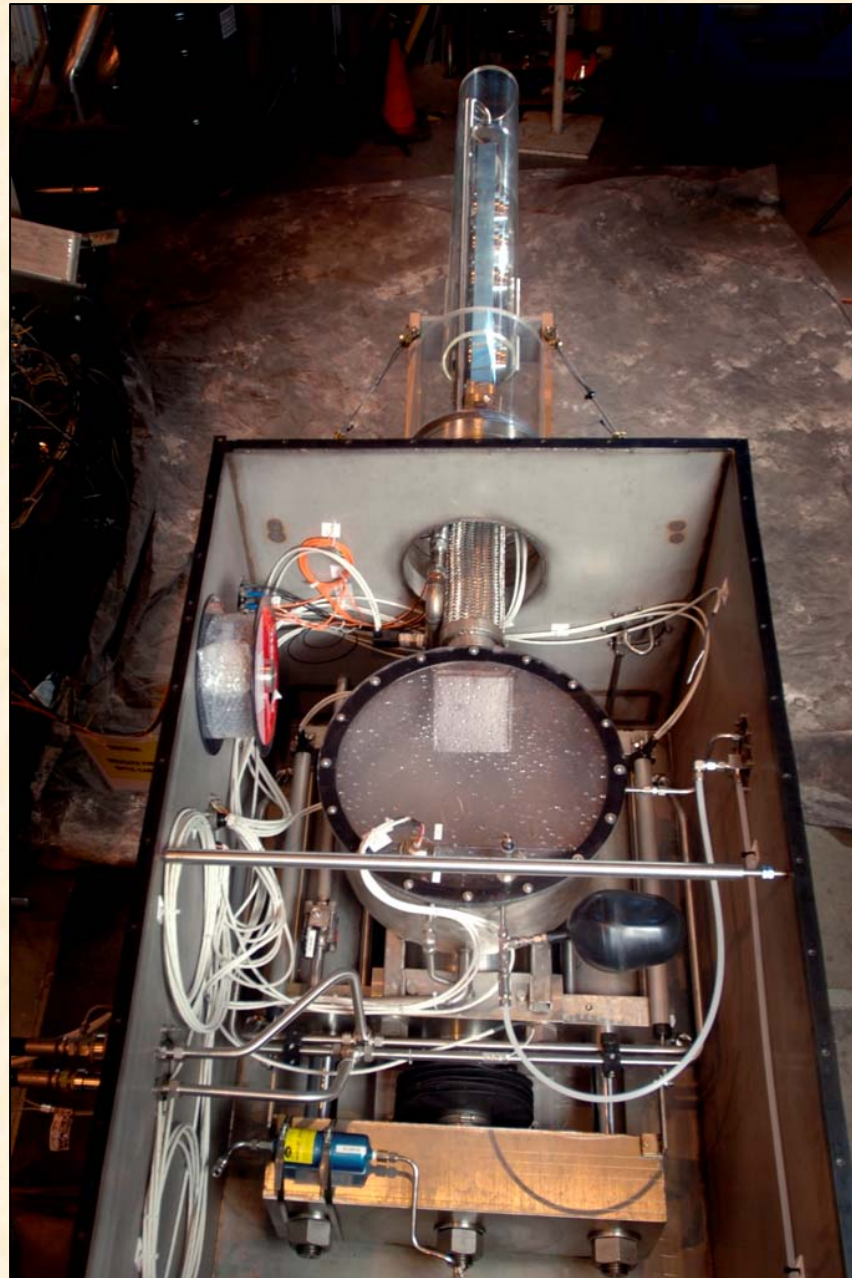

OAK RIDGE NATIONAL LABORATORY
U. S. DEPARTMENT OF ENERGY

MUTAC Review BNL 18 Apr 2007

UT-BATTELLE

Syringe Statistics

- 30hp / 4000psi (260 bar) / 12.9gpm hydraulic pump
- 40 gal vegetable-oil based hydraulic fluid
- Hg flow rate 1.6liter/s (24.9gpm)
- Piston velocity 3.0cm/s (1.2in/sec)
- Up to 100 bar (1500 psi) Hg pressure in cylinder
- Hg cylinder force 525kN (118kip)



OAK RIDGE NATIONAL LABORATORY
U. S. DEPARTMENT OF ENERGY

UT-BATTELLE

MIT Testing Result Summary



- Completed 14 runs with field (10-15-20 m/s jets, 5-10-15 Tesla fields)
- Syringe pump performed as expected, no leaks
- Expected increased Hg pressure due to field, but no effects observed
- Water vapor issues inside jet chamber resulted in addition of strip heater on exterior of chamber
- External bore heater had to be reconfigured due to clearance issues





Solenoid Current Traces

- 9-sec ramp up
- 4-sec ramp down
- 30 MJ heating → 30K temperature rise

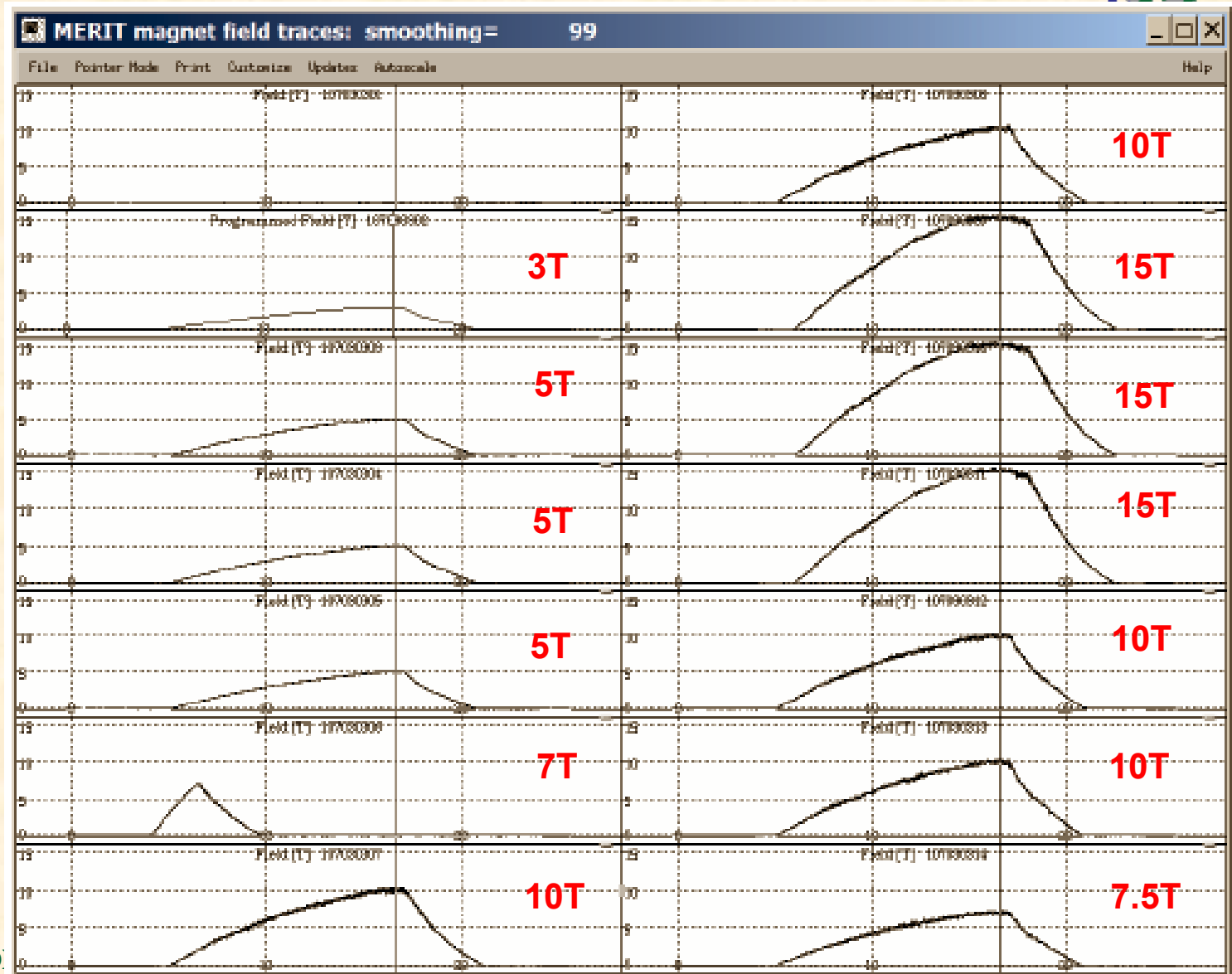



Jet/Solenoid Time Sequence

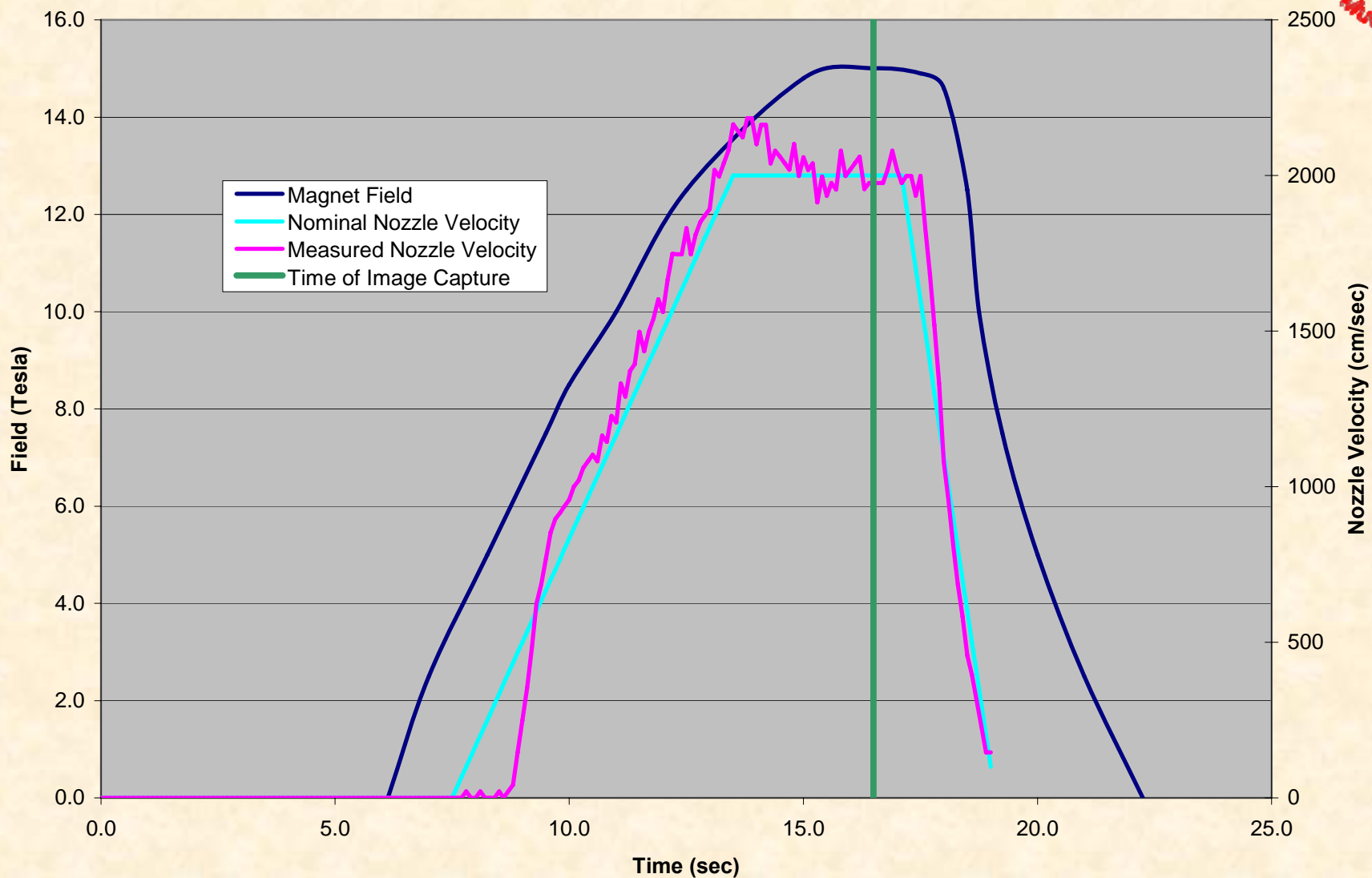



Hg & Hydraulic Pressure Comparison - 0T vs. 15T 20m/s Hg Jets

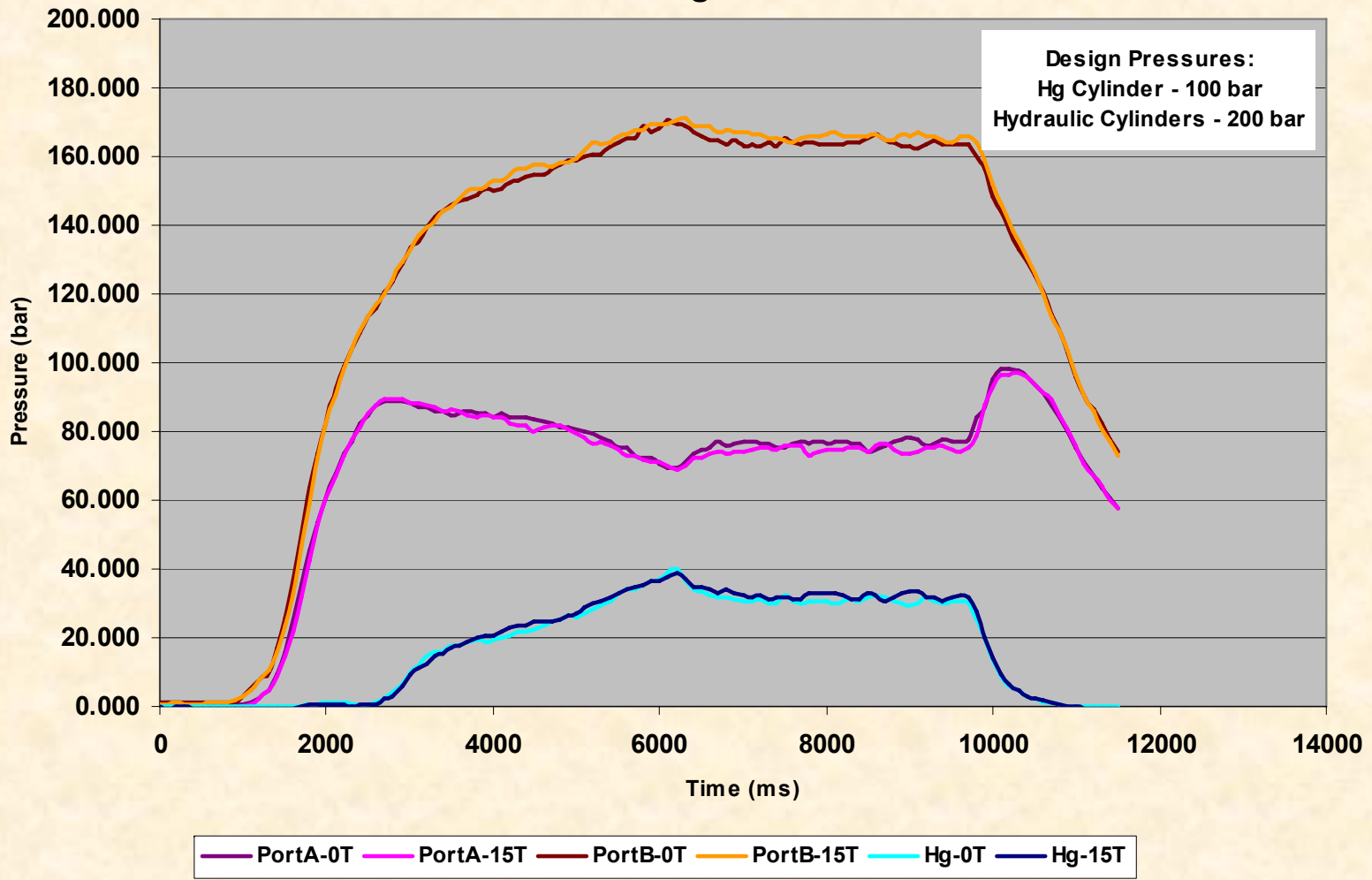



Nozzle Velocity Comparison - 0T vs. 15T

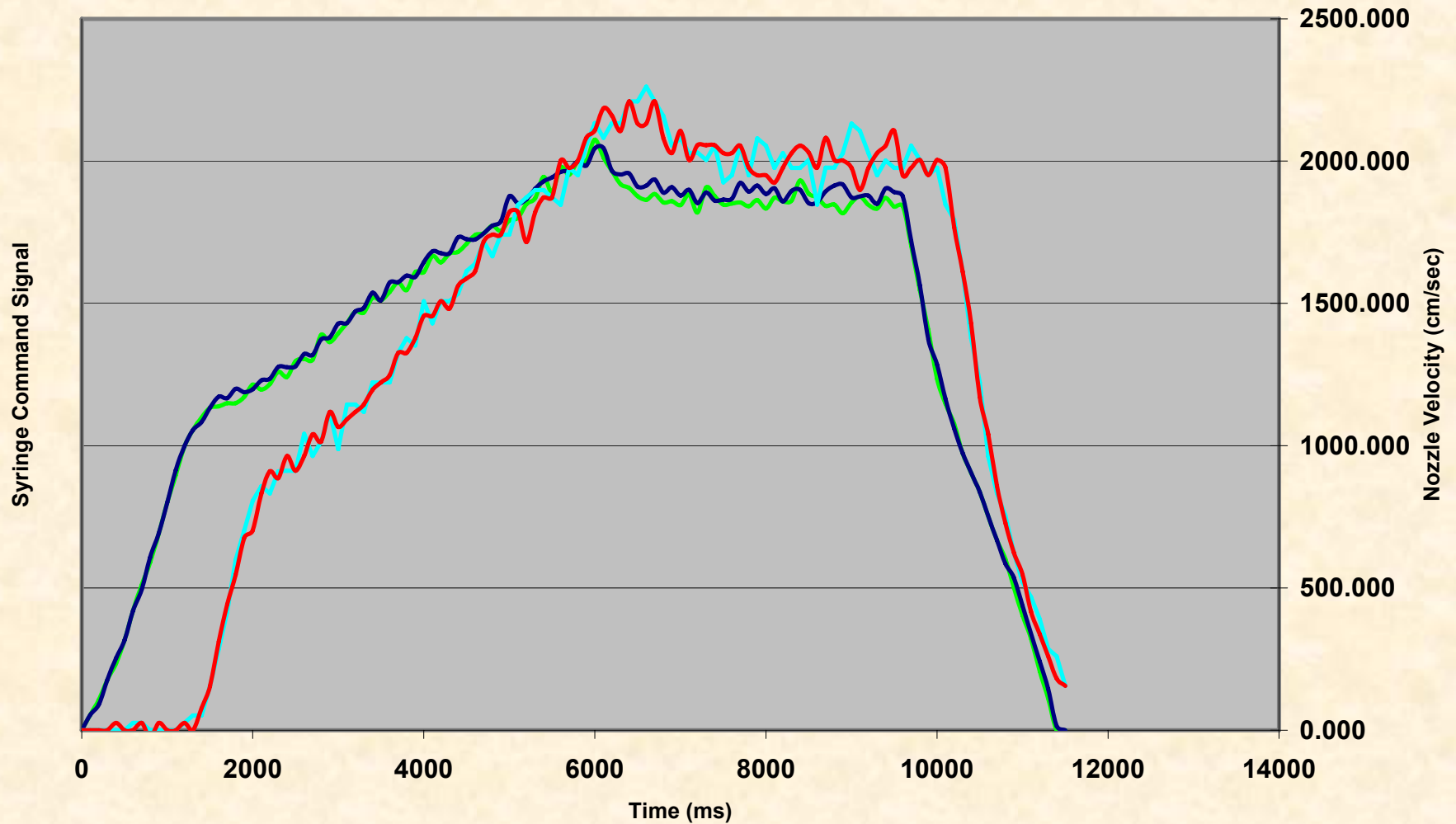

— Syringe Command 0T — Syringe Command 15T — Nozzle Velocity 0T — Nozzle Velocity 15T

Images of Mercury Jet vs. Magnetic Field ($V=10\text{m/s}$)

Viewport 1

Viewport 2

Viewport 3

0 T

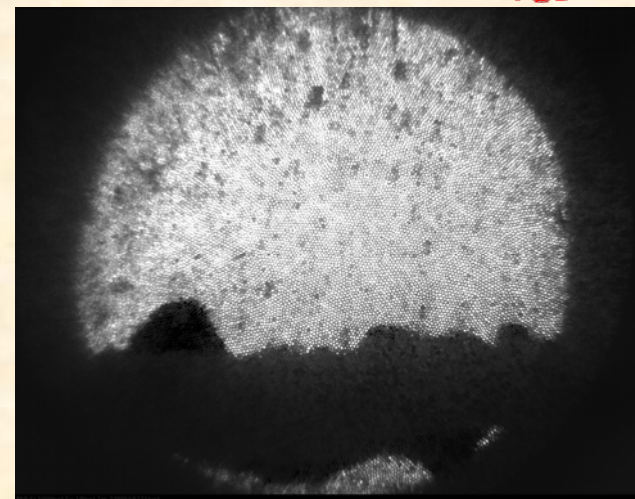
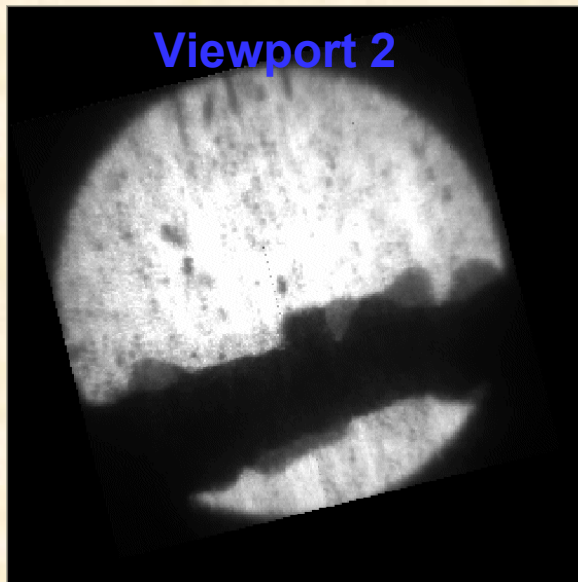

15 T

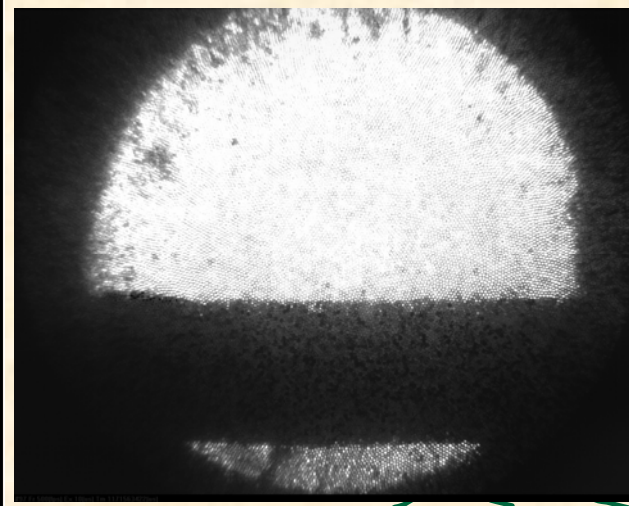
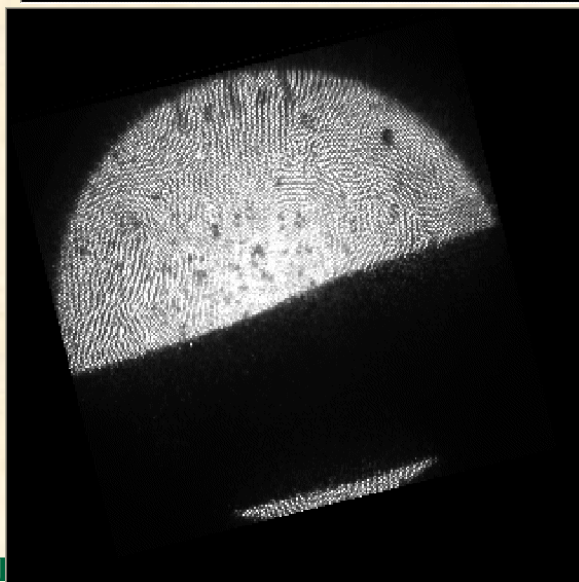
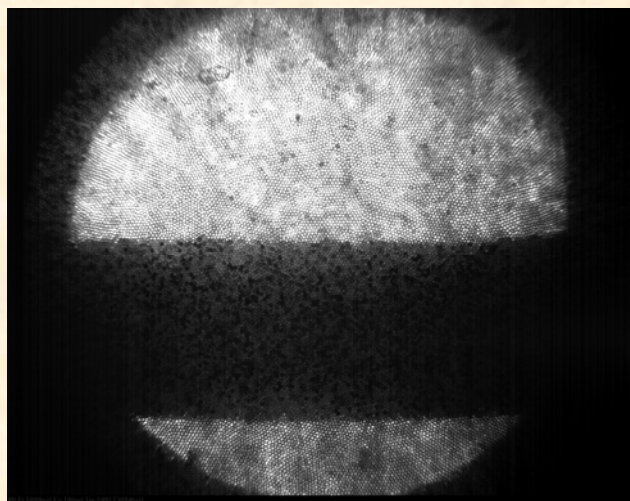

Images of Mercury Jet vs. Magnetic Field ($V=15\text{m/s}$)

Viewport 1

Viewport 2

Viewport 3

0 T

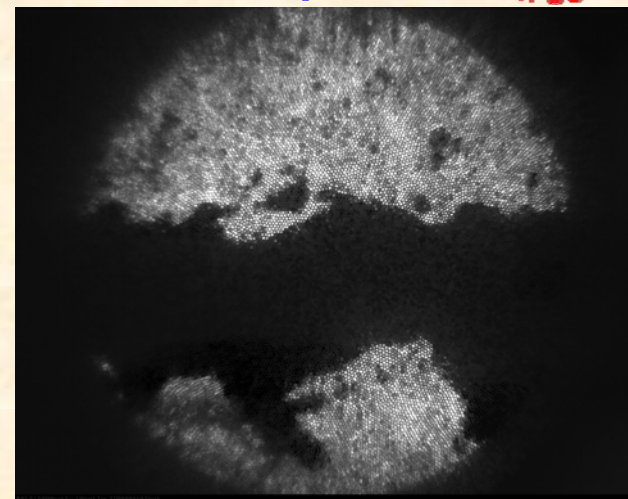

15 T

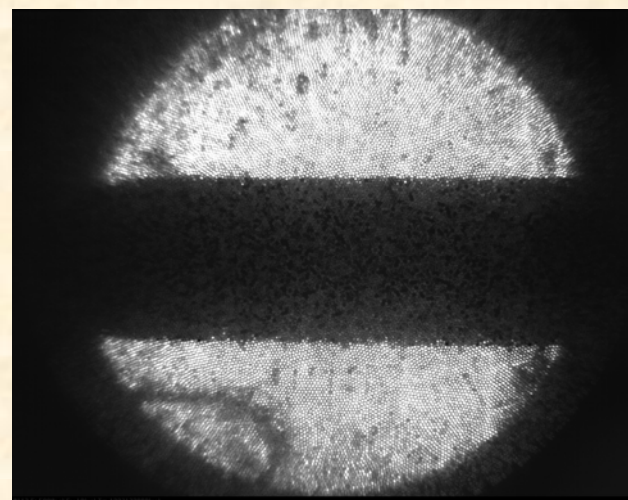
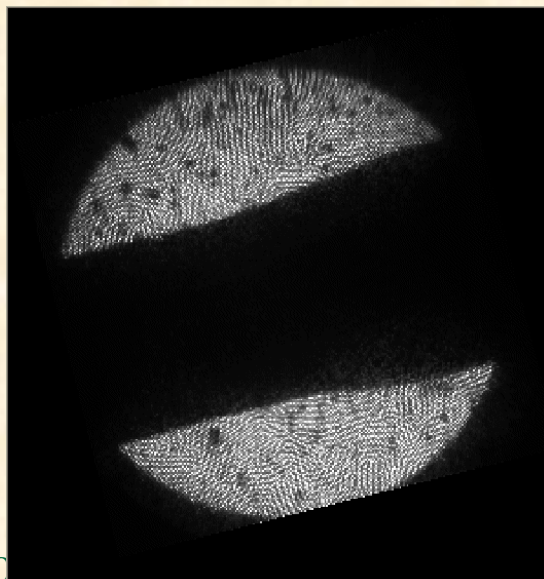
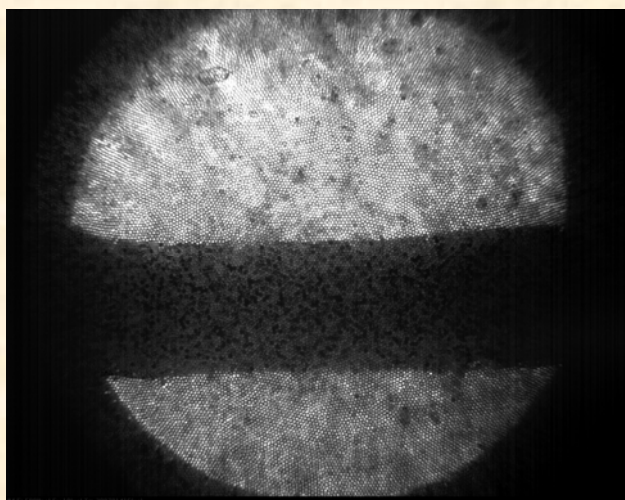

Images of Mercury Jet vs. Magnetic Field ($V=20\text{m/s}$)

0 T

Viewport 1

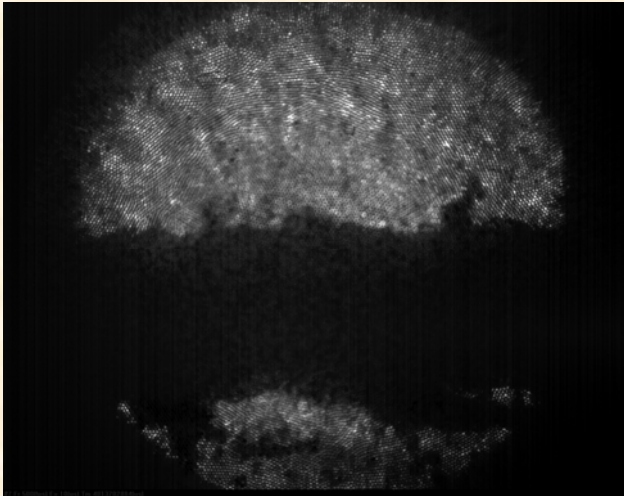

Viewport 2

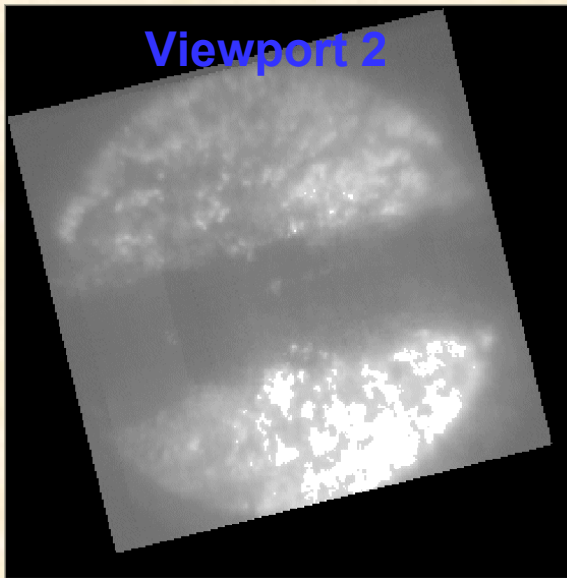

Viewport 3

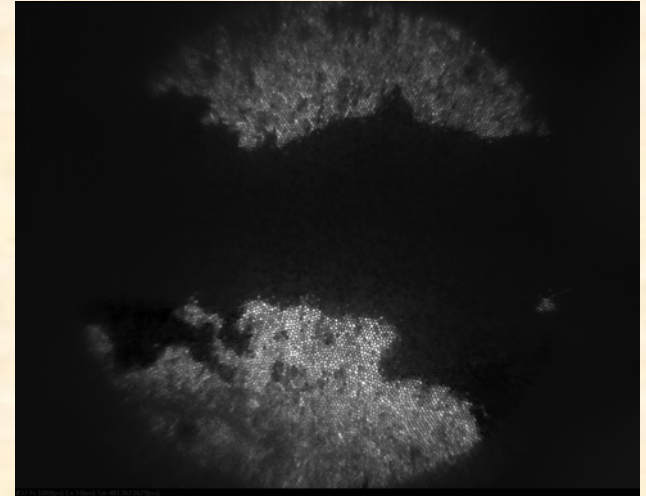

15 T

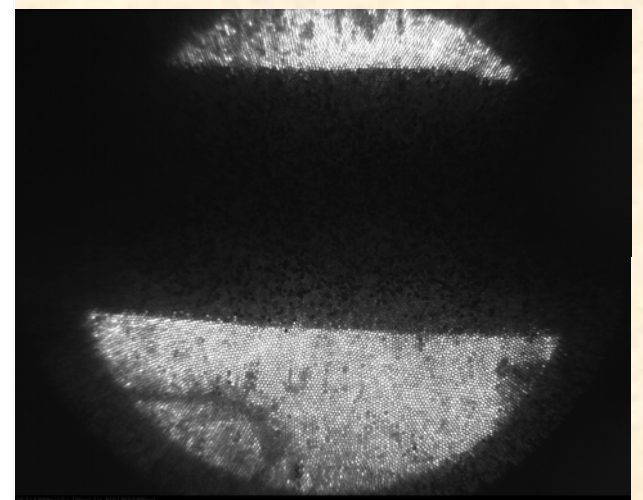
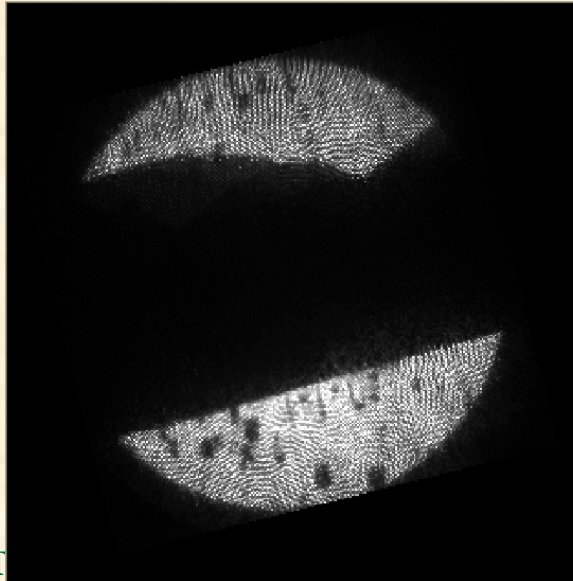
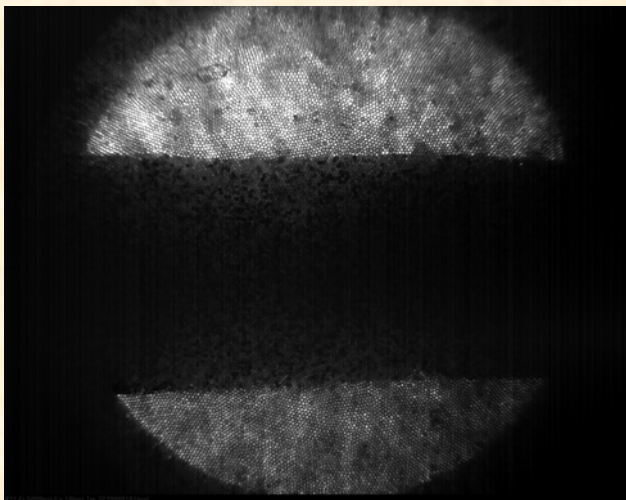



Visual Observations

- Magneto hydro-dynamic motion of Hg jet was observed at viewport 1,2,3,4 and was measured at viewport 2.
- Jet breakup was observed downstream at zero magnetic field. Jet breakup was not observed when magnetic field was applied but some surface disturbance was still present.
- At nonzero magnetic field, the bottom of the jet was smoother than the top was. The surface perturbations were more prominent at low magnetic field, but still present at 15 T.

Hg Jet Size at Viewport 2

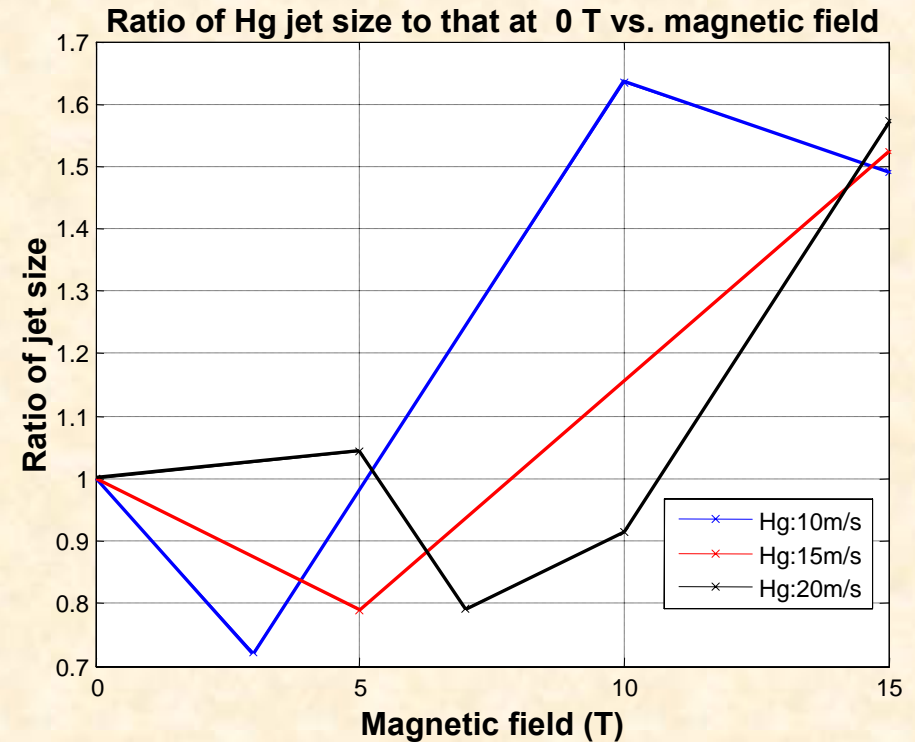
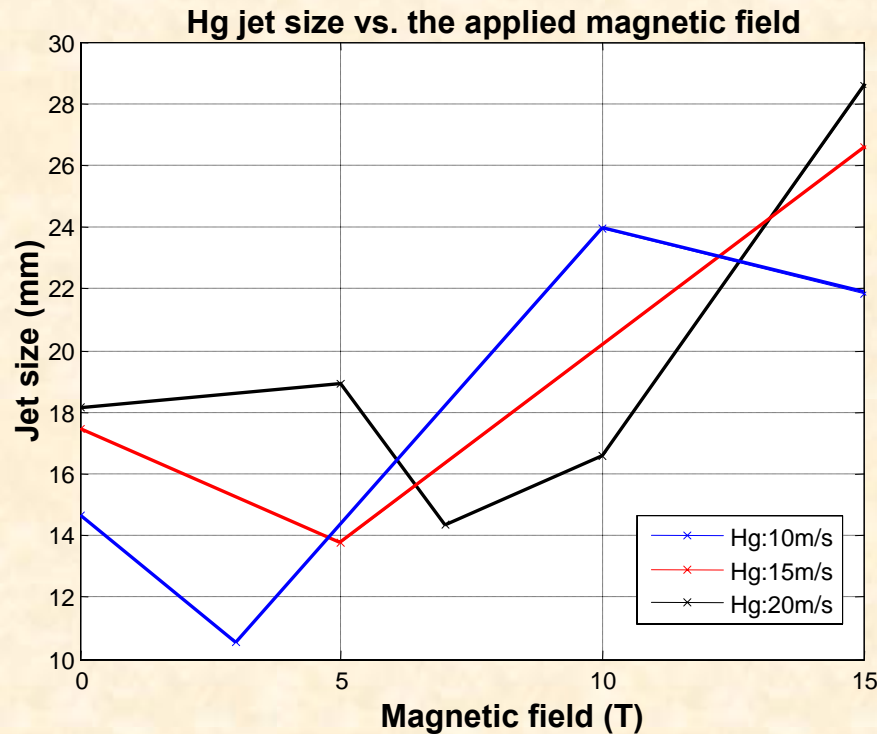

• Observations

- Simulations indicated quadrupole effect -> change in jet cross section from circular to elliptical
- Jet size approximately same at 0T/5T, increased at higher fields
- For 20m/s jet, size was smaller at 10T than at 15T

Hg Jet Size at Viewport 2 (cont'd)

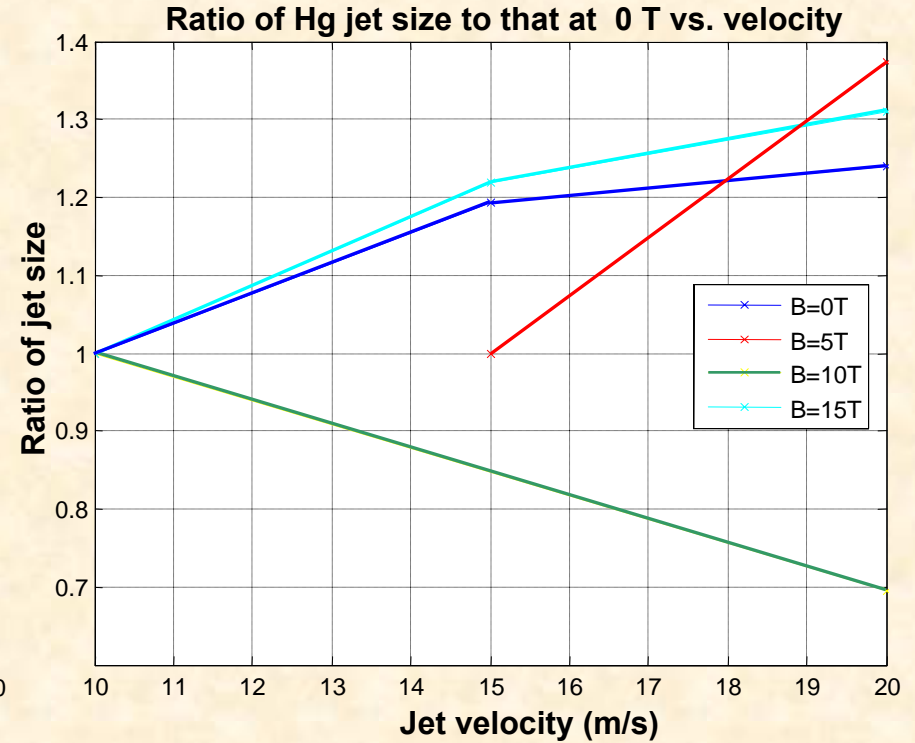
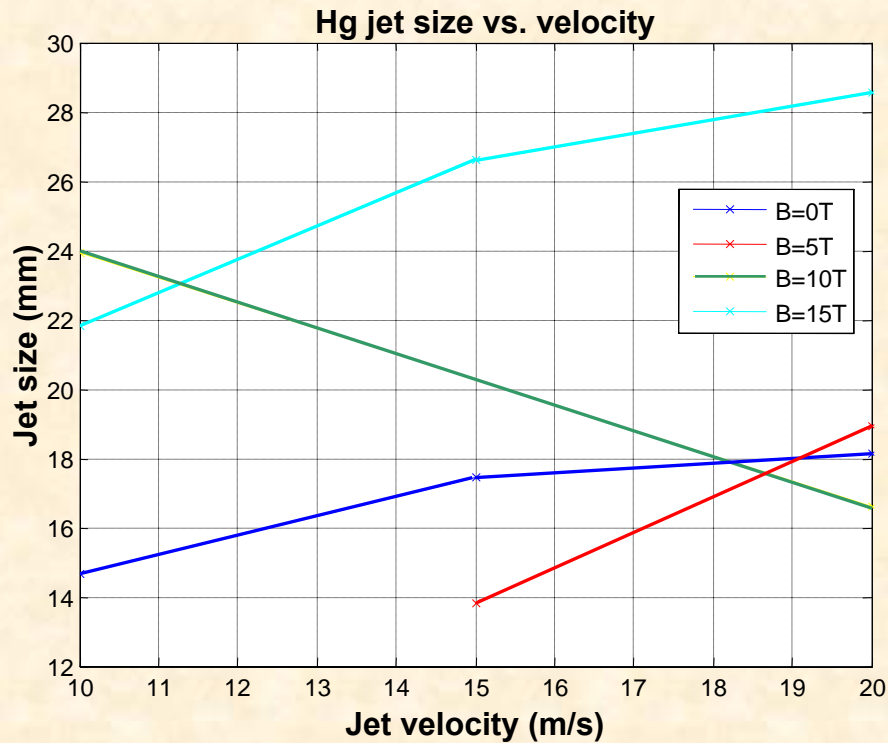

- **Observations**

- In general, size of Hg jet increased as jet velocity increased
- 10T case does not follow this trend, possibly due to quadrupole effect

Hg Jet Velocity vs. Magnetic Field

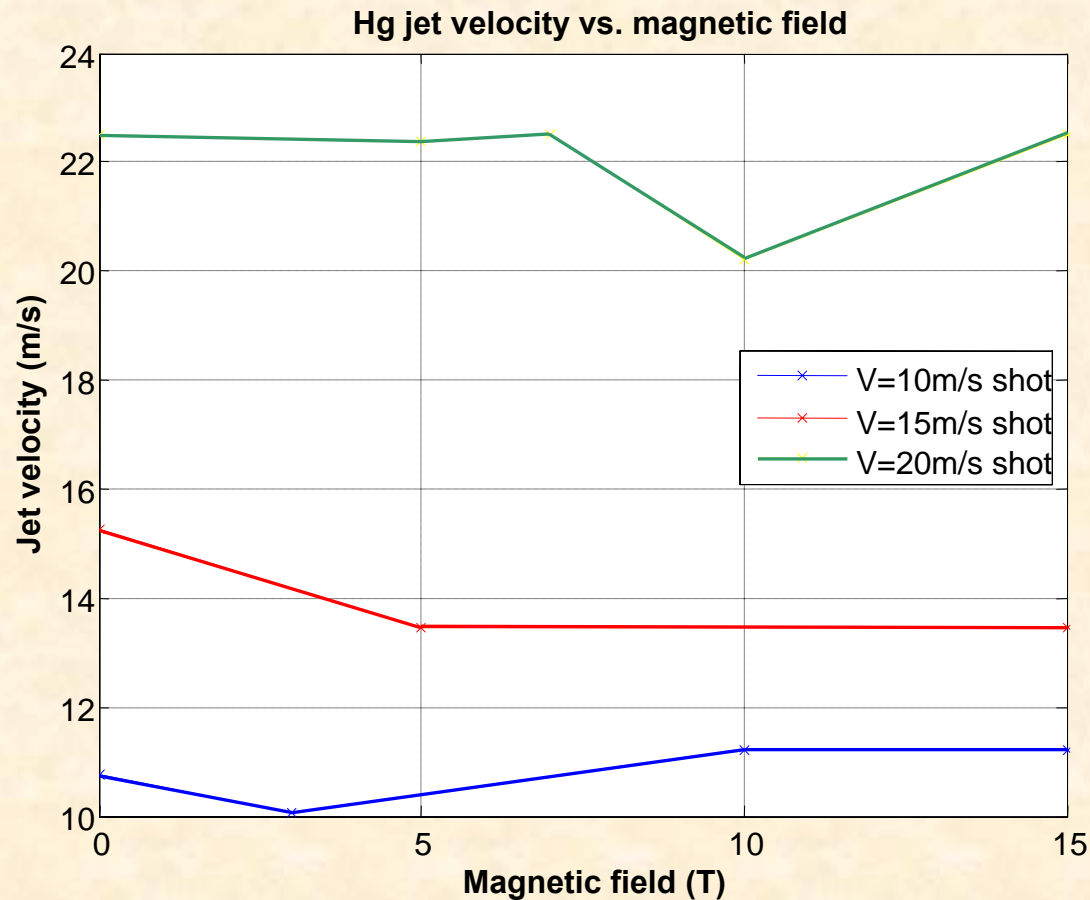

- **Observation**

- Jet velocity independent of magnetic field
- Corroborates syringe pump sensor data

OAK RIDGE NATIONAL LABORATORY
U. S. DEPARTMENT OF ENERGY

H.Park, BNL



Hg System Operational Experience



- **Hg fill/drain process performed twice without incident**
- **Control system functions as expected**
 - Tested emergency stop conditions
- **Small Hg leak occurred at ORNL**
 - Contained within secondary, no problems in cleanup
- **Hg vapor detection and capture**
 - Vapor monitors work as expected
 - Local ventilation system (Scavenger) quickly removes any vapors within secondary, zero emissions detected at exhaust

Addition of Strip Heaters

- **Approx 0.5L water not removed from system prior to Hg operations at ORNL**
- **Insertion into magnet caused condensation on viewports**
- **Modified existing flexible heaters to prevent condensation**
- **New heaters and controllers procured for CERN operation**



Hg Fill & Drain Procedures Tested



- Two fill and drain cycles completed
 - MIT cycles observed by CERN personnel
- Peristaltic pump method works well, minimizes spill risk & vapor generation
- Drain into intermediate container reduces chance of overflowing flask
- Flasks weighed empty & full to track inventory
- No spills or operational problems



OAK RIDGE NATIONAL LABORATORY
U. S. DEPARTMENT OF ENERGY

MUTAC Review BNL 18 Apr 2007



Hg Leak Experienced

- **Very high vapor levels inside secondary detected at ORNL**
 - No vapors detected outside secondary
 - Scavenger snorkel successfully removed vapors
- **Suspected Hg cylinder bellows & made effort to seal seams**
 - Upon disassembly, no vapors detected inside bellows
- **Small Hg leak discovered in nozzle supply threaded joint**
- **Successfully removed liquid and tightened joint**



Leak Location

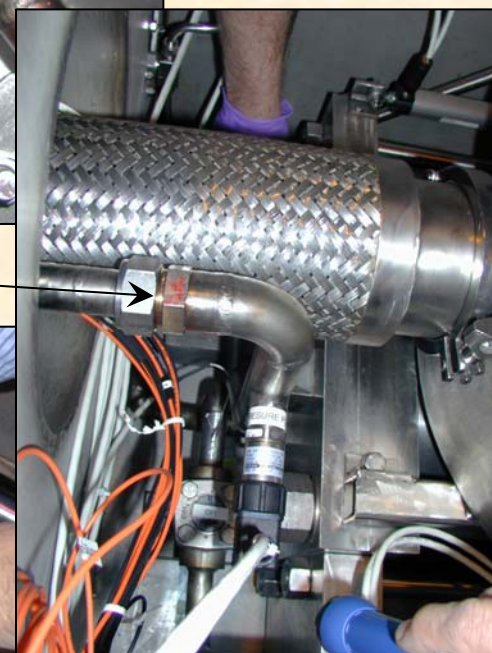

Bellows



Conclusions

- **System operating characteristics have been quantified during ORNL and MIT testing**
 - Hg target, optical diagnostics, solenoid performing as expected
 - Operational issues with solenoid being resolved
- **15T field induced no additional pressure on Hg piping, system well within design pressures**
- **Hg leak experienced**
 - Detected with instrumentation, contained within secondary, successfully mitigated
 - Secondary containment prevented vapor escape
 - Valuable operational experience gained
- **Further non-beam studies to be conducted during system commissioning at CERN**
- **On-track for in-beam testing July 2007**