



ELSEVIER

Available online at www.sciencedirect.com

SCIENCE @ DIRECT®

Nuclear Instruments and Methods in Physics Research A 503 (2003) 70–77

NUCLEAR
INSTRUMENTS
& METHODS
IN PHYSICS
RESEARCH
Section A

www.elsevier.com/locate/nima

An R&D program for targetry and capture at a neutrino factory and muon collider source

A. Hassenein^a, A. Bernadon^b, D.L. Beshears^c, K.A. Brown^d, M.C. Cates^c,
A. Fabich^b, R.C. Fernow^d, C.C. Finfrock^d, Y. Fukui^e, T.A. Gabriel^c,
D.M. Gassner^d, M.A. Green^f, G.A. Greene^d, J.R. Haines^c, C.D. Johnson^b,
S.A. Kahn^d, B.J. King^d, H.G. Kirk^d, J. Lettry^b, C. Lu^g, H. Ludewig^d,
K.T. McDonald^{g,*}, J.R. Miller^h, N.V. Mokhovⁱ, R.B. Palmer^d, A.F. Pendzick^d,
R. Prigl^d, H. Ravn^b, L.L. Reginato^f, B.W. Riemer^c, R. Samulyak^d, J. Scaduto^d,
N. Simos^d, P.T. Spampinato^c, P. Thieberger^d, C.-C. Tsai^c, T.Y.F. Tsang^d,
H. Wang^d, R.J. Weggel^d, A. Zeller^j

^a Argonne National Laboratory, Argonne, IL 60439, USA

^b CERN, Geneva, Switzerland

^c Oak Ridge National Laboratory, Oak Ridge, TN 37831, USA

^d Brookhaven National Laboratory, Upton, NY 11973, USA

^e University of California at Los Angeles, Los Angeles, CA 90095, USA

^f Lawrence Berkeley National Laboratory, Berkeley, CA 94720, USA

^g Princeton University, Princeton, NJ 08544, USA

^h National High Magnetic Field Laboratory, Tallahassee, FL 32310, USA

ⁱ Fermi National Accelerator Laboratory, Batavia, IL 60510, USA

^j Michigan State University, East Lansing, MI 48824, USA

Abstract

The need for intense muon beams for muon colliders and for neutrino factories based on muon storage rings leads to a concept of 1–4 MW proton beams incident on a moving target that is inside a 20-T solenoid magnet, with a mercury jet as a preferred example. Novel technical issues for such a system include disruption of the mercury jet by the proton beam and distortion of the jet on entering the solenoid, as well as more conventional issues of materials lifetime and handling of activated materials in an intense radiation environment. As part of the R&D program of the Neutrino Factory and Muon Collider Collaboration, an R&D effort related to targetry is being performed within the context of experiment E951 at Brookhaven National Laboratory, first results of which are reported here.

© 2003 Elsevier Science B.V. All rights reserved.

PACS: 29.25–t

Keywords: Target; Neutrino factory; Muon collider

*Corresponding author.

E-mail address: mcdonald@puphep.princeton.edu (K.T. McDonald).

1. The targetry concept

A muon collider [1] or a neutrino factory-based on a muon storage ring [2–4] require intense beams of muons, which are obtained from the decay of pions produced in proton–nucleus collisions. To maximize the yield, pions of momentum near 300 MeV/c should be captured [5–8], as illustrated in Fig. 1. For proton energies above 10 GeV, the pion yield per unit of proton beam energy is larger for a high-Z target [7], as shown in Fig. 2. For proton beam energies in the MW range, beam heating would melt or crack a stationary high-Z target [9], so a moving target must be used. A mercury jet target is the main focus of BNL E951 [5], although R&D is also being conducted on a carbon target option [2,10,11] as might be suitable for a low-energy proton source [12], and conceptual studies have been carried out for rotating-band targets [13,14], a tantalum/water target [15], and a liquid-lithium target [16].

The low-energy pions are produced with relatively large angles to the proton beam, and efficient capture into a decay and phase rotation channel is obtained by surrounding the target with a 20-T solenoid magnet, whose field tapers down to 1.25 T over several meters [17,18], as sketched in Fig. 3. See also Figs. 2 and 3 of Ref. [8]. Pion yield is maximized with a mercury target in the form a 1-cm-diameter cylinder (Fig. 4), tilted by about

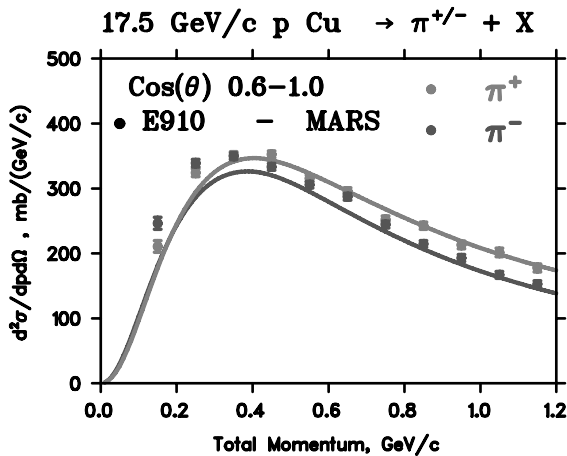

Fig. 1. Comparison of pion yield measured in BNL E910 [6] with a MARS calculation [7].

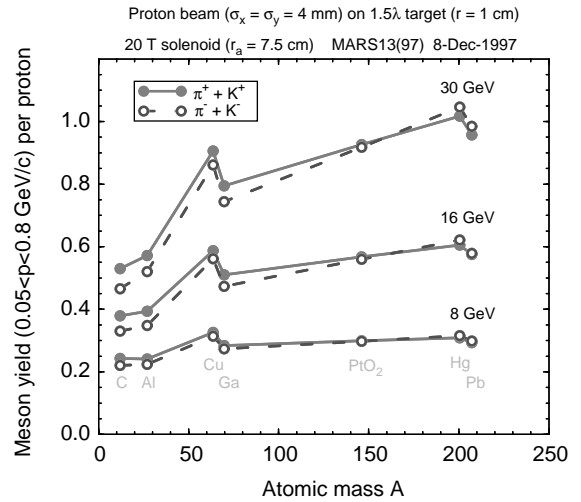

Fig. 2. Calculated yield of pion vs. atomic mass number of targets in proton beams of 8, 16 and 30 GeV [7].

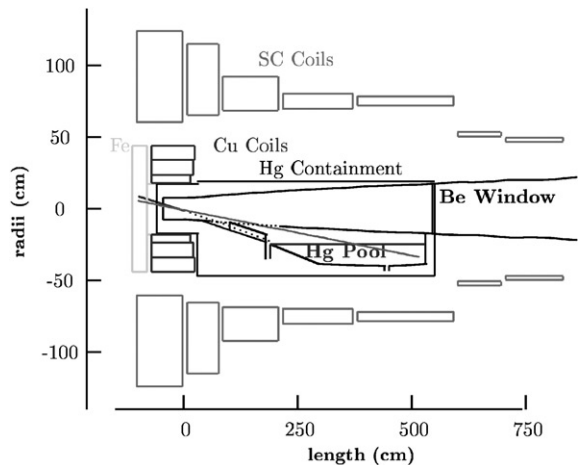

Fig. 3. Concept of targetry based on a mercury jet and proton beam at 100 and 66 mrad, respectively, to the axis of a 20-T solenoid magnet.

100 mrad with respect to the magnetic axis (Fig. 5). To permit the proton beam to interact with the target over 2 interaction lengths, the proton beam is tilted by 33 mrad with respect to the mercury jet axis.

The use of a mercury jet target raises several novel issues. The rapid energy deposition in the mercury target by the proton beam leads to intense

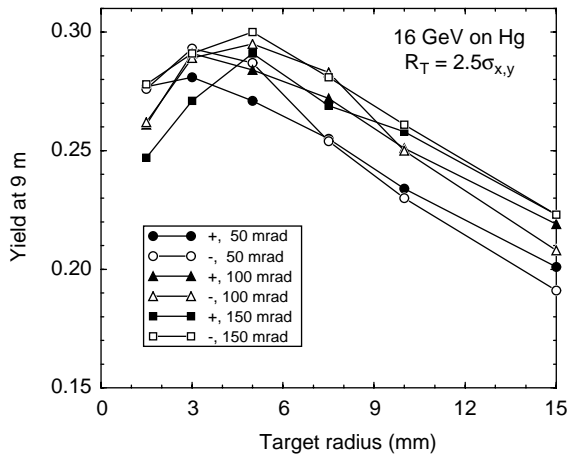

Fig. 4. Calculation of the yield of pions as a function of radius of a mercury target, assuming the proton beam has $\sigma_r = 0.4r_{\text{target}}$ [7].

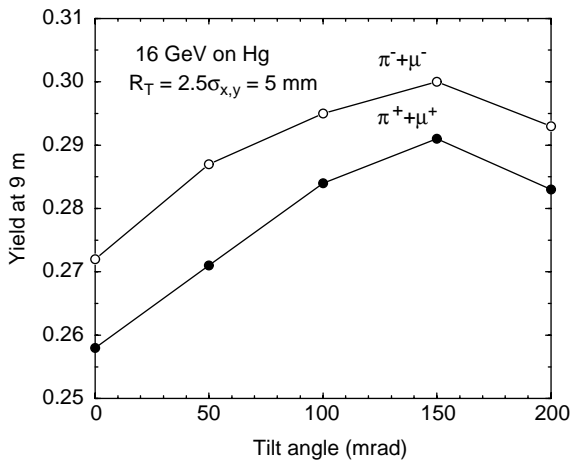

Fig. 5. Calculation of the yield of pions from a mercury target as a function of the tilt angle of the proton beam and target to the axis of a 20-T solenoid magnet [7].

pressure waves that can disperse the mercury [5,19–23]. Further, as the mercury enters the strong magnetic field eddy currents are induced in the mercury, and the Lorentz force on these currents could lead to distortion of the jet [5,23–28]. On the other hand, the magnetic pressure on the mercury once inside the solenoid will damp mechanical perturbation of the jet [20,29].

To address these issues an R&D program is now underway.

2. The targetry R&D program

In the USA, R&D on targetry for a neutrino factory and muon collider has been formalized as BNL experiment 951 [5]. This project maintains close contacts with related efforts in Europe [30] and in Japan [31].

The broad goal of E951 is to provide a facility that can test the major issues of a liquid or solid target in intense proton pulses and in a 20-T magnetic field. A sketch of the eventual facility is shown in Fig. 6.

Present activities in E951 focus on the interaction of intense proton pulses with targets in zero magnetic field. European targetry studies presently emphasize the interaction of mercury jets with a magnetic field, the operation of RF cavities near high-power targets [32], and evaluation of target materials [33].

2.1. Mercury target studies

The present R&D program on mercury jets is an outgrowth of work at CERN in the 1980s in which a prototype mercury jet was prepared (Fig. 7), but was never exposed to a beam.

Experiment 951 is conducted in the A3 beamline of the BNL AGS [34] into which a single bunch, 100 ns long, of up to 5×10^{12} 24-GeV protons can be extracted and brought to a focus as small as $0.6 \times 1.6 \text{ mm}^2$. The dispersal of both static (Fig. 8) and moving (Fig. 9) mercury targets by the proton beam was observed via two high-speed cameras using shadow photography with a laser diode [35–37]. Figs. 10–12 show the effect of pulses of $2\text{--}4 \times 10^{12}$ 24-GeV proton on the mercury. Dispersal velocities of up to 50 m/s were observed. The air

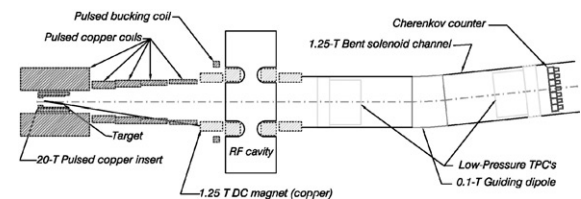
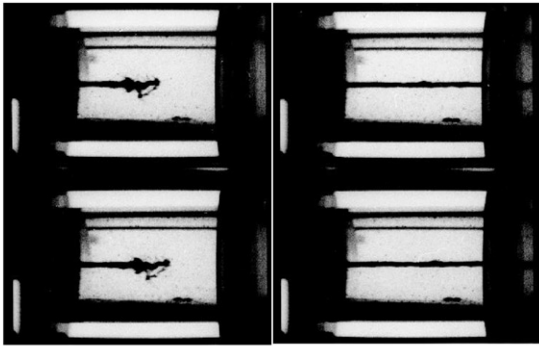

Fig. 6. Sketch of the full configuration of BNL E951, the targetry R&D facility.



High-speed photographs of mercury jet target for CERN-PS-AA (laboratory tests)
4,000 frames per second, Jet speed: 20 ms⁻¹, diameter: 3 mm, Reynold's Number > 100,000
A. Poncet

Fig. 7. Photographs of a 3-mm-diameter mercury jet (C.D. Johnson, 1988).

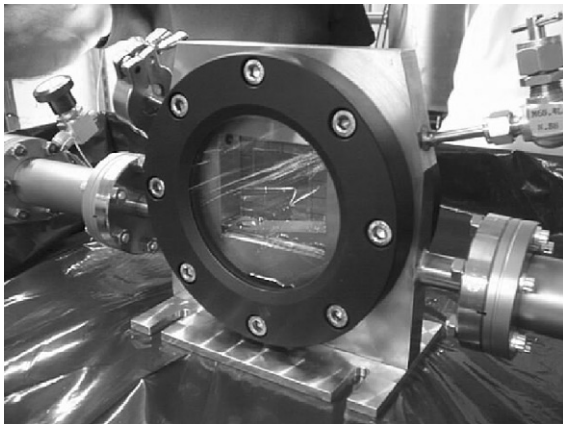

Fig. 8. Photograph of the static mercury target cell.

in the target cell slowed the droplet velocity by a factor of two over 10 cm. A key result from the jet studies was that the dispersal of mercury by the proton beam was confined to that part of the jet directly intercepted by protons.

Thus, it appears that the dispersal of mercury by a proton beam is dramatic, but not violent, and that the dispersal will be a relatively modest issue for a target facility that operates at 15 Hz [38].

2.2. Solid target studies

E951 included exposures of several solid targets to the proton beam, using fiberoptic strain sensors

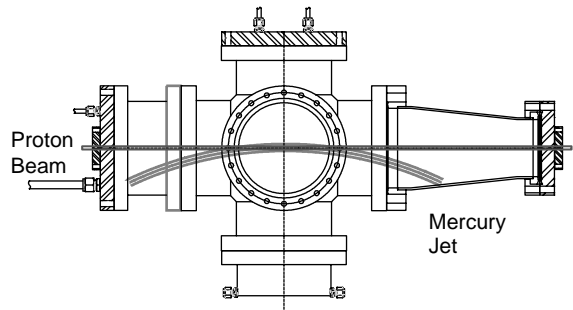

Fig. 9. Elevation view of the target cell that produced a 1-cm diameter jet of mercury with 2.5 m/s velocity that overlapped with the 24-GeV proton beam for 12 cm.

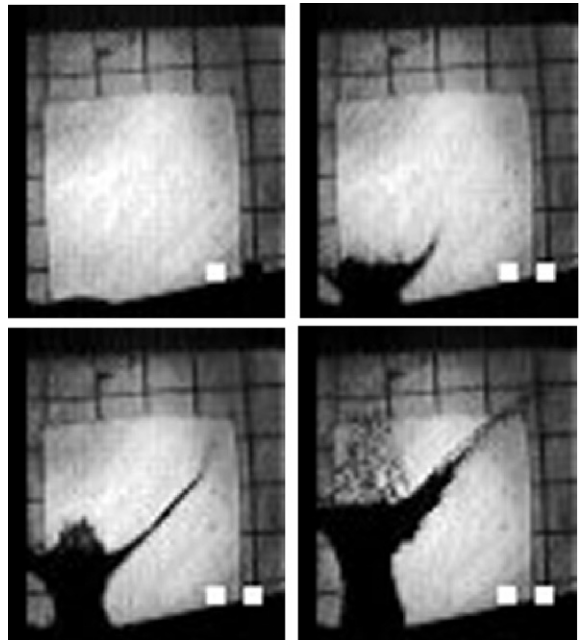

Fig. 10. Exposures of 25 μ s at $t = 0, 0.5, 1.6, 3.4$ ms after a pulse of 2×10^{12} protons interacted with a static “thimble” of mercury 1.0 cm in diameter and 1.5 cm deep. The grid is 1 cm \times 1 cm.

with 500 kHz bandwidth (Figs. 13,14) to characterize the transient response of the targets to the pressure waves induced by beam energy deposition [39]. As expected, a carbon-carbon composite target with thermal expansion coefficient of less than $10^{-6}/\text{K}$ showed much less strain than an ATJ graphite target (Fig. 15).

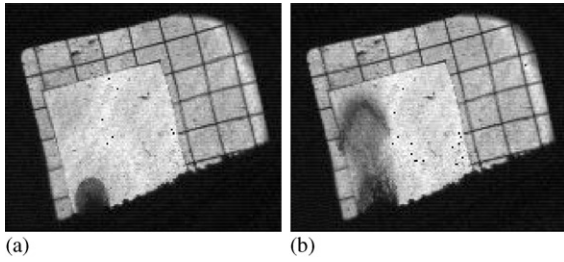

Fig. 11. Exposures of $0.2 \mu\text{s}$ at $t =$ (a) 0.3, and (b) 0.8 ms after a pulse of 4×10^{12} protons interacted with a static “thimble” of mercury. The grid is $1 \text{ cm} \times 1 \text{ cm}$.

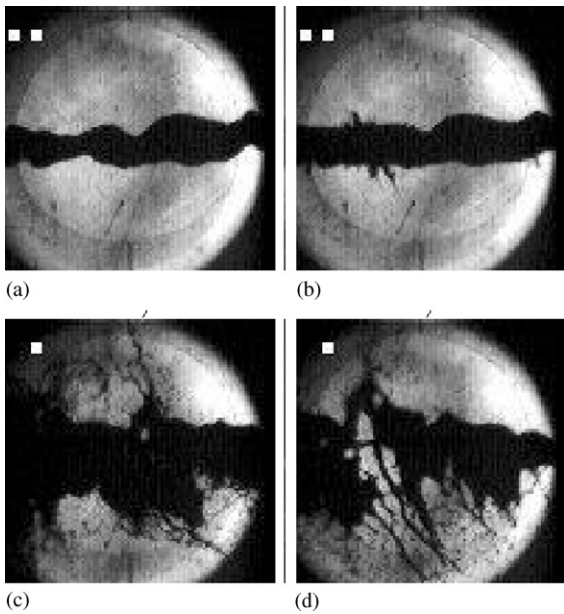

Fig. 12. Exposures of $25 \mu\text{s}$ at $t =$ (a) 0, (b) 0.75, (c) 10, and (d) 18 ms after a pulse of 3.8×10^{12} protons interacted with a free jet of mercury 1 cm in diameter.

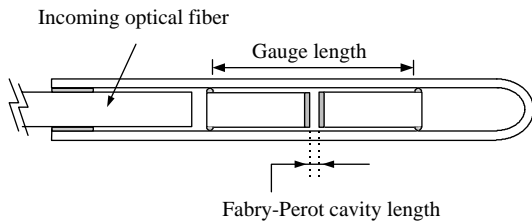

Fig. 13. Sketch of a fiberoptic strain sensor (FISO Technologies, <http://www.fiso.com>).

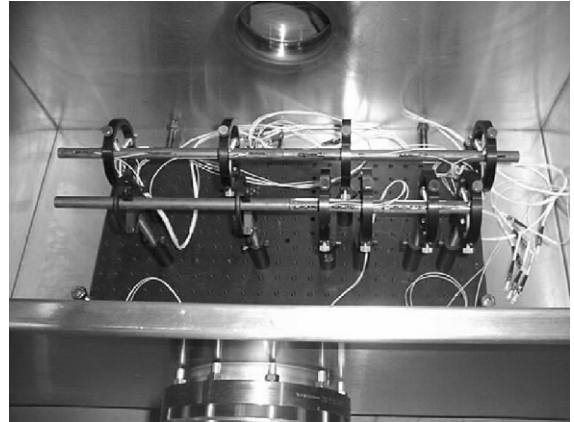
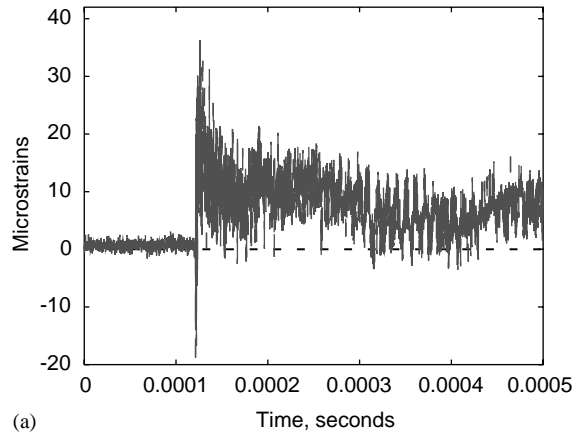
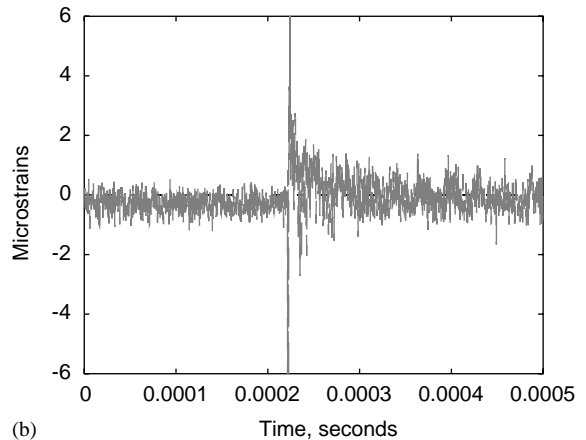

Fig. 14. View of the ATJ carbon and carbon–carbon composite targets equipped with fiberoptic strain sensors.



(a)



(b)

Fig. 15. Fiberoptic strain gauge data from carbon targets: (a) a pulse of 3×10^{12} 24-GeV protons on ATJ carbon and (b) a pulse of 2×10^{12} protons on a carbon–carbon composite.

The issue of the rate of sublimation of carbon targets at the elevated temperatures ($> 1900^{\circ}\text{C}$) caused by exposure to a 1-MW beam is under continuing laboratory study. Calculations indicate that a helium atmosphere can greatly extend the operational life of a carbon target against sublimation [40].

3. The target facility

A preliminary design has been made of a target facility based on the concepts of the R&D program described above [3,8,41]. Low-energy pions are produced with relatively large angles to the proton beam, and efficient capture into a decay and phase rotation channel [42] is obtained by surrounding the target with a 20-T solenoid magnet, whose field tapers down to 1.25 T over several meters, as sketched in Fig. 16. Pion yield is maximized with a mercury target in the form a 1-cm-diameter cylinder, tilted by about 100 mrad with respect to the magnetic axis. To permit the proton beam to interact with the target over two interaction lengths, the proton beam is tilted by 33 mrad with respect to the mercury jet axis. See also Fig. 17.

A mercury pool inside the capture solenoid intercepts the mercury jet and the unscattered proton beam, as shown in Fig. 18. To suppress splashes of the mercury by the jet and/or proton beam as they enter the pool, a set of baffles can be arrayed above the pool and a particle bed

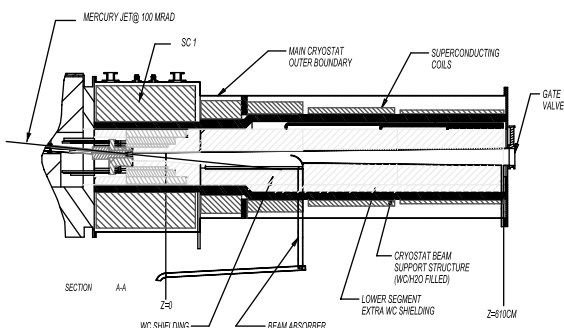

Fig. 16. Sketch of the target and capture system based on a mercury jet inside a 20-T solenoid magnet.

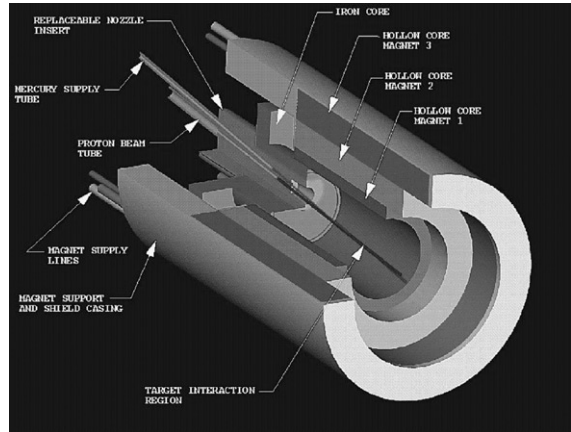

Fig. 17. The inner region of the 20-T capture magnet along with the tilted mercury jet target and proton beam.

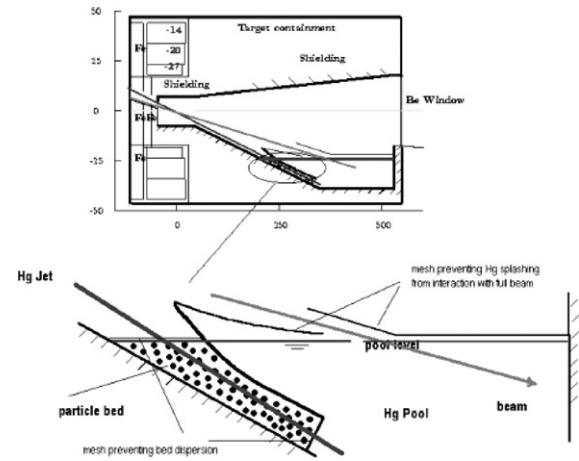

Fig. 18. A mercury pool inside the capture solenoid intercepts the mercury jet and the unscattered proton beam.

submersed within it. The mercury pool, surrounding tungsten carbide/water shielding, and the resistive insert of the 20-T capture magnet [18] are isolated from upstream and downstream beamline elements by a pair of double-walled Be windows. This entire unit can be replaced by remote manipulation should failure occur.

The absorbed radiation dose on components near the target is quite large [7], as illustrated in Fig. 19, such that in a 4 MW proton beam their

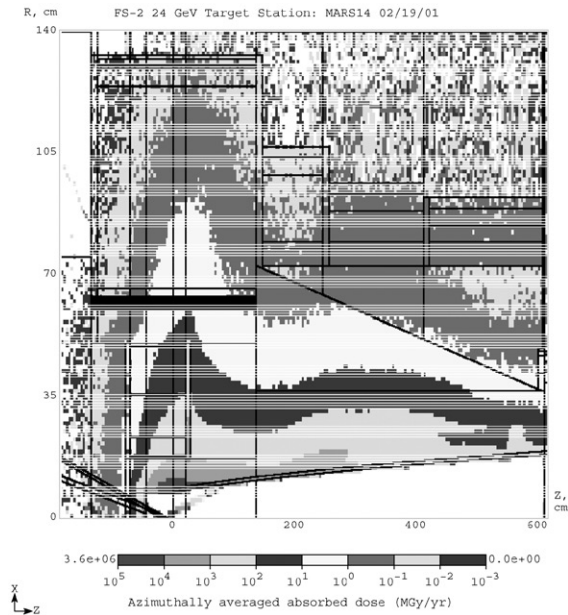

Fig. 19. Absorber radiation dose in the pion capture system per 2×10^7 s of a 1-MW, 24-GeV proton beam on a mercury target.

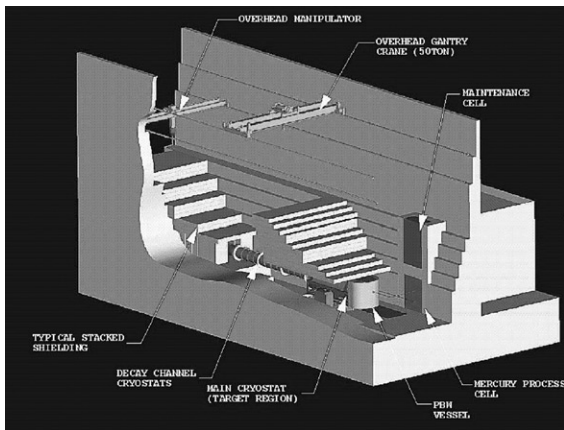

Fig. 20. Sketch of the target facility.

lifetime against radiation damage may only be 5 years.

The capture solenoid is encased in thick concrete shielding as part of the target facility that includes an overhead crane, hot cells with remote manipulation capability, and a mercury pumping and purification loop [41], as sketched in Fig. 20.

References

- [1] C.M. Ankenbrandt, et al. (The Muon Collider Collaboration), Status of muon collider research and development and future plans, *Phys. Rev. ST Accel. Beams* 2 (1999) 081001, <http://prst-ab.aps.org/abstract/PRSTAB/V2/i8/E081001/>
- [2] N. Holtkamp, D. Finley (Eds.), A Feasibility Study of a Neutrino Source Based on A Muon Storage Ring, <http://www.fnal.gov/projects/muon Collider/nu-factory/>
- [3] S. Ozaki, et al. (Eds.), Feasibility Study-II of a Muon-Based Neutrino Source, <http://www.cap.bnl.gov/mumu/studyii/FS2-report.html>
- [4] R. Palmer, et al., A second feasibility study of a muon storage ring neutrino factory, PAC2001, FOAC007.
- [5] J. Alessi, et al., An R&D program for targetry at a muon collider, proposal to the BNL AGS, September 1998; <http://puhep1.princeton.edu/mumu/target/targetprop.ps>; <http://puhep1.princeton.edu/mumu/target/pulsedjet.ps>
- [6] I. Chemakin, et al., Inclusive soft pion production from 12.3 and 17.5 GeV/c Protons on Be, Cu and Au, August 6, 2001, nucl-ex/0108007
- [7] N. Mokhov, Particle production and radiation environment at a neutrino factory target station, PAC2001, FOAC010; see also <http://www-mucool.fnal.gov/mcnotes/muc0194.ps>
- [8] A. Hassenein, et al., The primary target facility for a neutrino factory-based on muon beams, PAC2001, TPAH155.
- [9] R. Horne, C.D. Johnson, Post-irradiation examination of a high-intensity proton beam target, <http://nicewww.cern.ch/~cdj/public/p-i-exam/pbartga4.htm>
- [10] B. Riemer, Graphite rod test/simulation response from LANSCE-WNR proton beam, <http://puhep1.princeton.edu/mumu/target/graphite-lansce.pdf>
- [11] B. Riemer, Stresses in ATJ graphite rod from AGS beam, <http://puhep1.princeton.edu/mumu/target/graphite.stress.pdf>
- [12] B. Autin, et al., Design of a 2.2 GeV accumulator and compressor for a neutrino factory, <http://nicewww.cern.ch/~molat/neutrino/nf31.ps>.
- [13] B. King, et al., An inconel rotating band pion production target for neutrino factories and muon colliders, PAC2001, TPAH136; see also <http://www-mucool.fnal.gov/mcnotes/muc0199.pdf>
- [14] J.R.J. Bennett, A high power, radiation cooled rotating toroidal target for neutrino production, http://puhep1.princeton.edu/mumu/target/bennett_011900.pdf
- [15] P. Sievers, A stationary target for the CERN-neutrino factory, <http://nicewww.cern.ch/~molat/neutrino/nf65.pdf>
- [16] V. Balbekov, N. Mokhov, Low-budget muon source, PAC2001, TPAH144.
- [17] R.J. Weggel, Conceptual design of a magnet system to generate 20 T in a 0.15 m diameter bore, employing an inductor precooled by liquid nitrogen, *IEEE Trans. Appl. Supercond.* 11 (2000), <http://puhep1.princeton.edu/mumu/target/mt16.ps>

- [18] R.J. Weggel, et al., Design study for 20 T, 15 cm bore hybrid magnet with radiation-resistant insert for pion capture, PAC2001, RPPH074.
- [19] C.D. West, Cavitation in a mercury target, ORNL/TM-2000/263, http://puhep1.princeton.edu/mumu/target/hg_cavitation.pdf
- [20] P. Sievers, P. Pugat, Response of solid and liquid targets to high power proton beams for Neutrino factories, <http://nicewww.cern.ch/~molat/neutrino/nf35.pdf>
- [21] N. Simos, et al., Thermodynamic interaction of the primary proton beam with a mercury jet target at a neutrino factory source, PAC2001, RPAH076.
- [22] A. Hassanein, I. Konkashbaev, Thermoelastic response of suddenly heated liquid and solid targets for high power colliders, PAC2001, RPAH071.
- [23] R. Samulyak, W. Oh, Global numerical modeling of the muon collider target, PAC2001, TPAH139.
- [24] P. Thieberger, Estimated perturbations of the axial motion of a liquid-metal jet entering a strong magnetic field, <http://www-mucool.fnal.gov/mcnotes/muc0182.pdf>
- [25] K.T. McDonald, Magneto-hydrodynamics of a continuous mercury jet coaxially entering a solenoid, <http://puhep1.princeton.edu/mumu/target/continuousjet.ps>
- [26] J. Gallardo, et al., First-order perturbative calculations for a conducting liquid jet in a solenoid, <http://pubweb.bnl.gov/people/palmer/nu/study2/jet/jet.pdf>
- [27] S. Kahn, et al., Calculations for a mercury jet target in a solenoid magnet capture system, PAC2001, ROPB010.
- [28] A. Hassanein, I. Konkashbaev, Dynamics of liquid metal jets penetrating a strong magnetic field, PAC2001, ROPB009.
- [29] K.T. McDonald, Damping of radial pinch effects, <http://puhep1.princeton.edu/mumu/target/radialpinch>
- [30] B. Autin, European R&D, presented at NuFACT'01 (May 26, 2001), <http://www-prism.kek.jp/nufact01/May26/Plenary/26ple.autin.pdf>
- [31] K. Nakamura, An international agreement for neutrino factory R&D, presented at NuFACT'01, May 26, 2001, <http://www-prism.kek.jp/nufact01/May28/Plenary/28ple.nakamura.pdf>
- [32] N. Marseille, W. Pirkel, Sparking cavity test report, <http://nicewww.cern.ch/~molat/neutrino/nf52.pdf>
- [33] P. Drumm, C. Densham, Material testing for neutrino factory targets, PAC2001, TPAH157.
- [34] K. Brown, et al., First beam tests of the muon collider target test beam line at the AGS, PAC2001, TPAH129.
- [35] T.Y.F. Tsang, E951 diode laser operating procedures, <http://puhep1.princeton.edu/mumu/target/E951-laser-SOP-v3.doc>
- [36] A. Fabich, Experimental observation of MHD effects and proton-induced shocks in molten metals, presented at NuFACT'01, May 26, 2001, <http://afabich.home.cern.ch/afabich/docs/NUFact01talk.pdf>
- [37] H. Kirk, et al., Target studies with BNL E951 at the AGS, PAC2001, TPAH137.
- [38] P. Thieberger, Mercury storm in the reaction chamber of the Muon Storage Ring and Collider project, <http://www-mucool.fnal.gov/mcnotes/muc0212.pdf>
- [39] N. Simos, et al., Thermal shock analysis of windows interacting with energetic, focused beam of the BNL muon target experiment, PAC2001, TPAH085.
- [40] P. Thieberger, Upper limits for sublimation losses from hot carbon targets in vacuum and in gases, <http://www-mucool.fnal.gov/mcnotes/muc0186.pdf>
- [41] P. Spampinato, et al., Target enclosure/system design for a mercury-target neutrino producing facility, PAC2001, TPAH154.
- [42] H. Kirk, et al., Phase rotation at the front end of a neutrino factory, PAC2001, TPPH161.