

High-Power Targets and Particle Collection

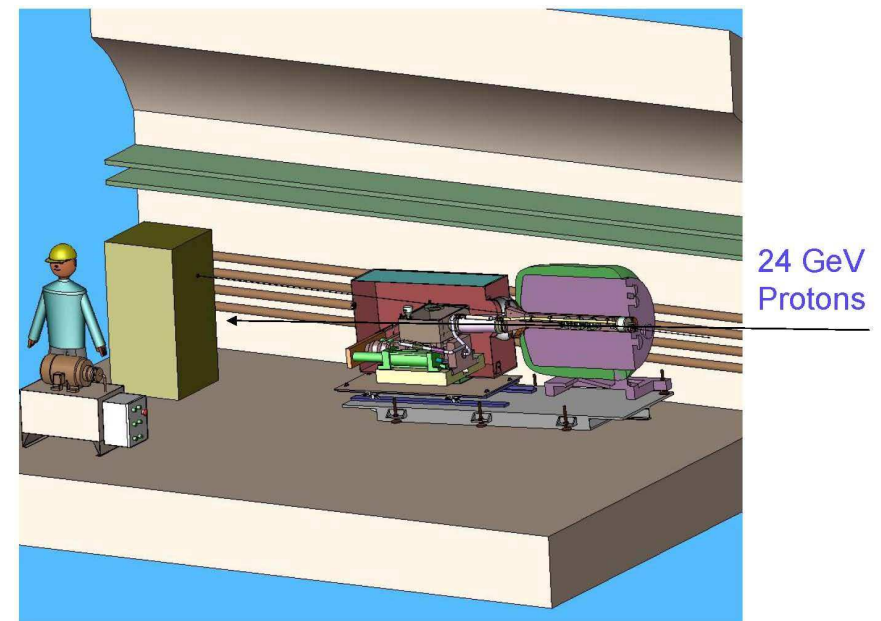
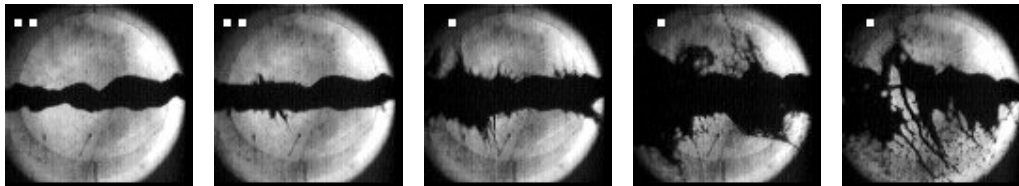
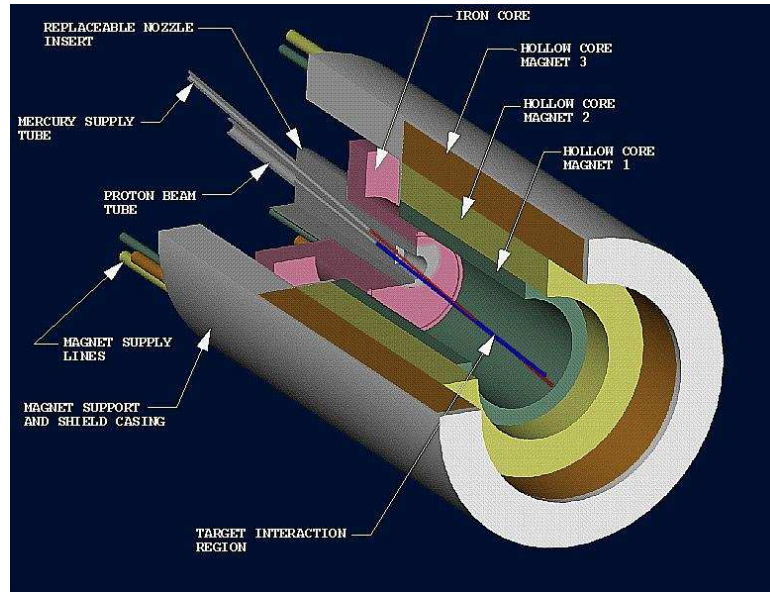

K.T. McDonald
Princeton U.
NuFACT'05
INFN Frascati
June 22, 2005

<http://puhep1.princeton.edu/mumu/target/>

(Proposed) Science with Multimegawatt Proton Sources

- **Neutrino Factories and Muon Colliders (1-4 MW).**
- **Neutron Spallation Sources (1-5 MW).**
- **Fusion Materials Test Facilities (10 MW).**
- **Accelerator Production of Tritium (4-40 MW).**
- **Accelerator Transmutation of Radioactive Waste (4-40 MW).**

High Power Target Issues

- **Target heating \Rightarrow Massive cooling and/or MOVING target.**
- **Radiation damage \Rightarrow Moving solid or LIQUID target.**
- **Thermal “shock” in pulsed beams \Rightarrow larger targets, or low-thermal expansion materials, or LIQUIDS.**

High-Power Targets Essential for Many Future Facilities

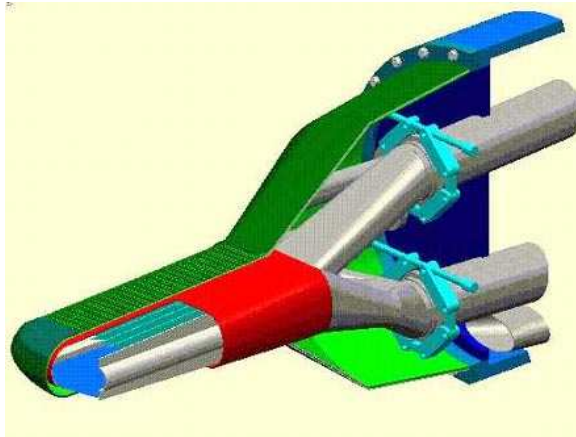

ESS

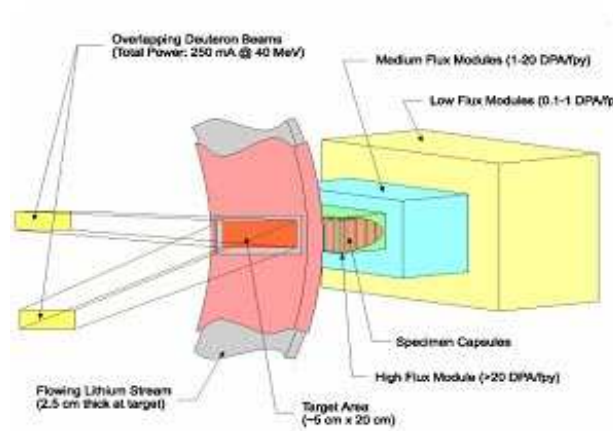

IFMIF

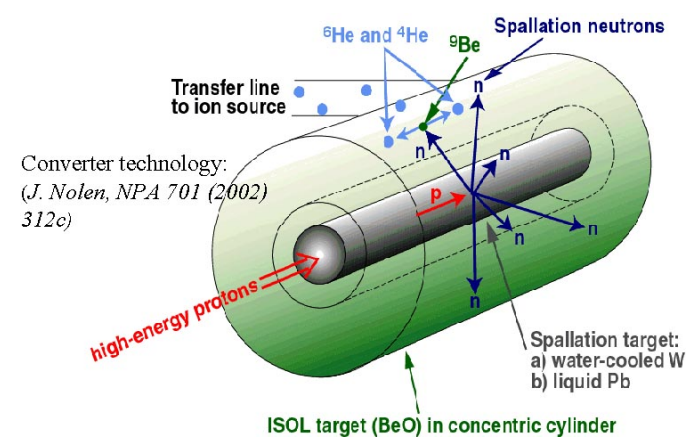

ISOL/ β Beams

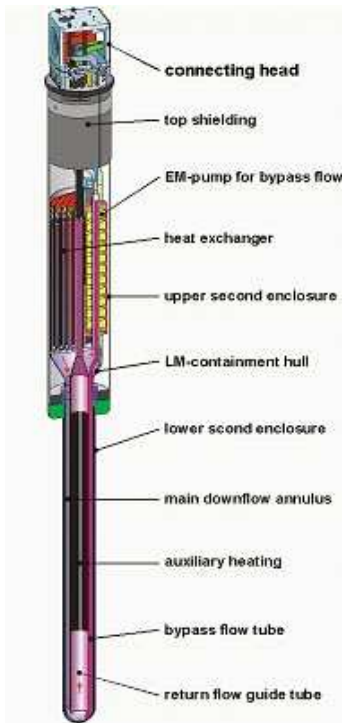

PSI

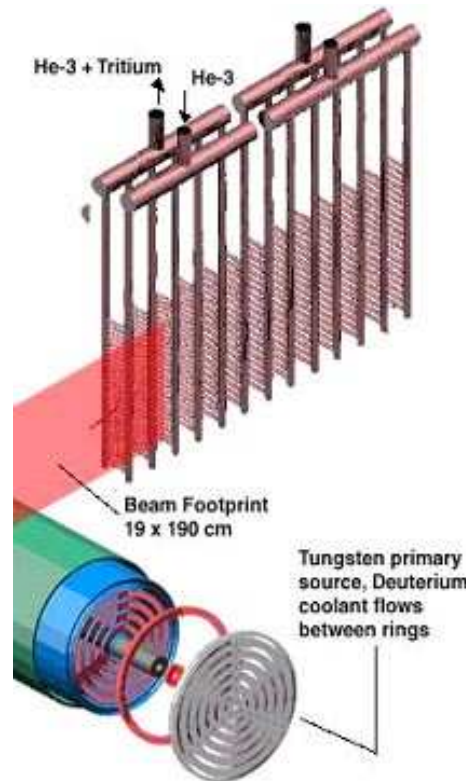

APT

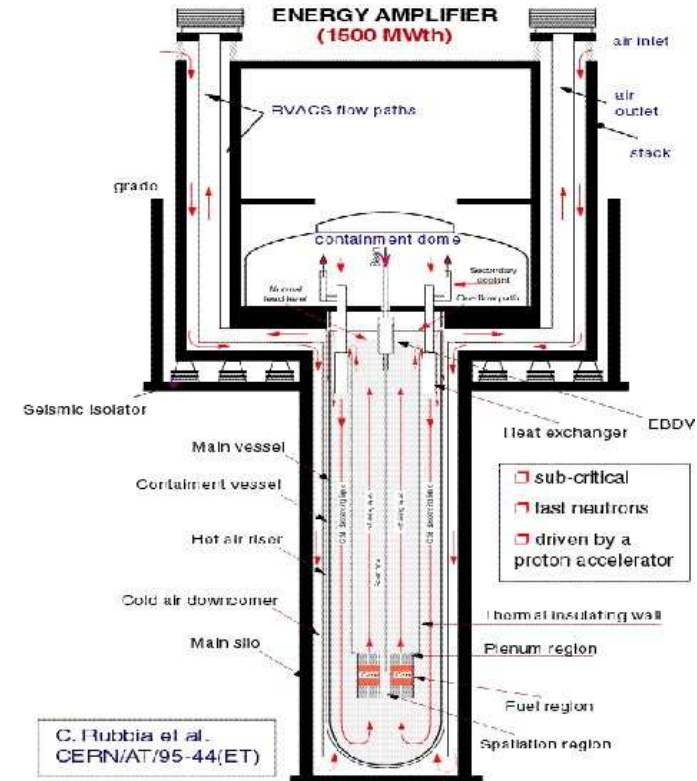

ATW

High-Performance Muon and Neutrino Beams Require a High-Performance Source

- The concept of a muon collider (Budker & Skrinsky – 1970's, Neuffer – 1980's) is enthusiastically revived during the 1992 Port Jefferson workshop.

Bob Noble proposes π/μ collection via a Li lens (toroidal magnetic field).

- Bob Palmer proposes solenoid capture of π 's & μ 's from a multimegawatt proton beam during the 1994 Sausalito workshop (BNL-61581, 1995).

Possibly inspired by Djilkibaev and Lobashev, Sov. J. Nucl. Phys. 49, 384 (1989), which also led to MECO.

- Colin Johnson proposes use of a mercury jet target for muon production during the (Jan.) 1997 Oxford, MS workshop, based on studies for an ACOL target in 1988.

- The Muon Collaboration is formed during the 1997 Orcas Island workshop, and inaugurates a program of high-power targetry R&D based on SOLENOID CAPTURE of π 's & μ 's from a FREE MERCURY JET TARGET.

A Liquid Metal Jet May Be the Best Target

for Beam Power above 1.5 MW (Neutrino Factory Feasibility Study 2)

Mercury jet target inside a magnetic bottle for good collection of low-energy pions: 20-T around target, dropping to 1.25 T in the pion decay channel.

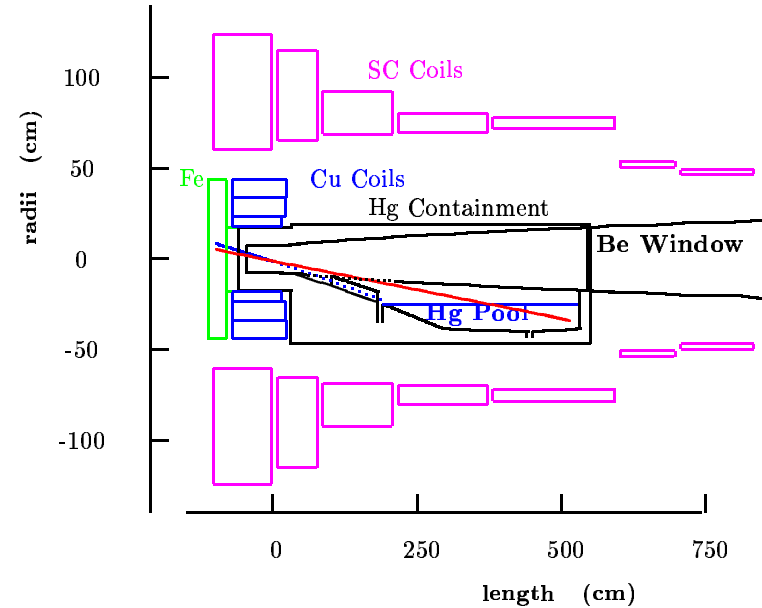

Mercury jet tilted by 100 mrad, proton beam tilted by 67 mrad, to increase yield of soft pions.

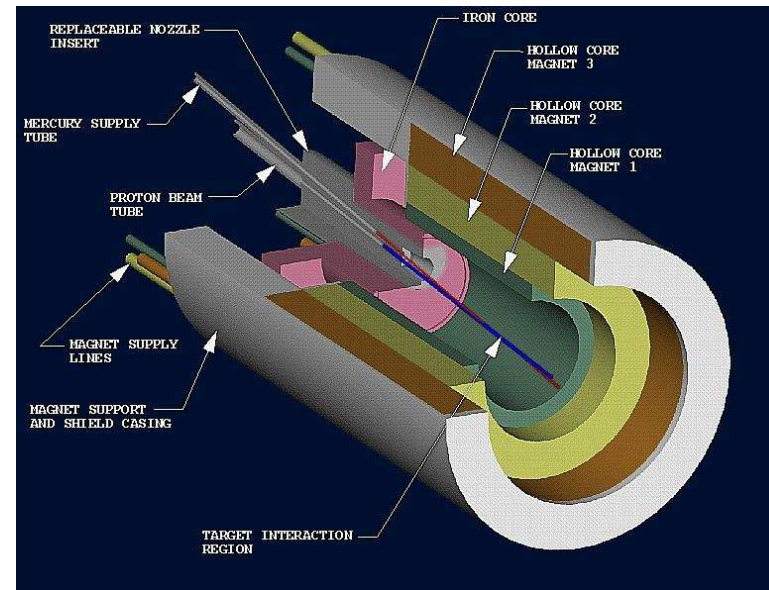

Beam-Induced Cavitation in Liquids Can Break Pipes

Snapping shrimp stun prey via cavitation bubbles.

ISOLDE:



BINP:

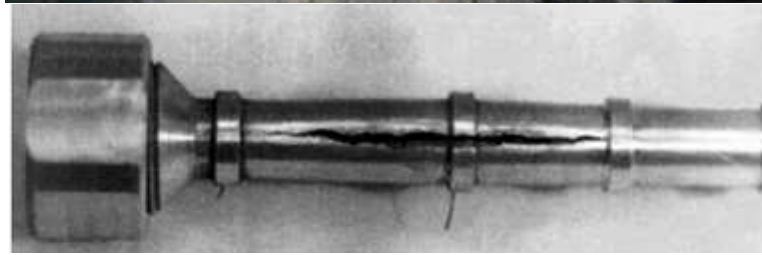

SNS:

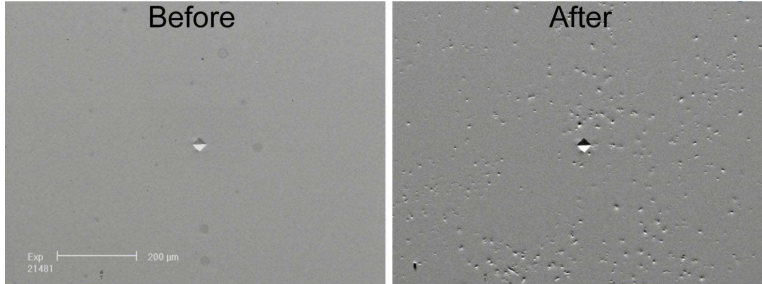

TL - High Power Target
 Specimen # 29754
 Equivalent SNS Power Level = 2.5

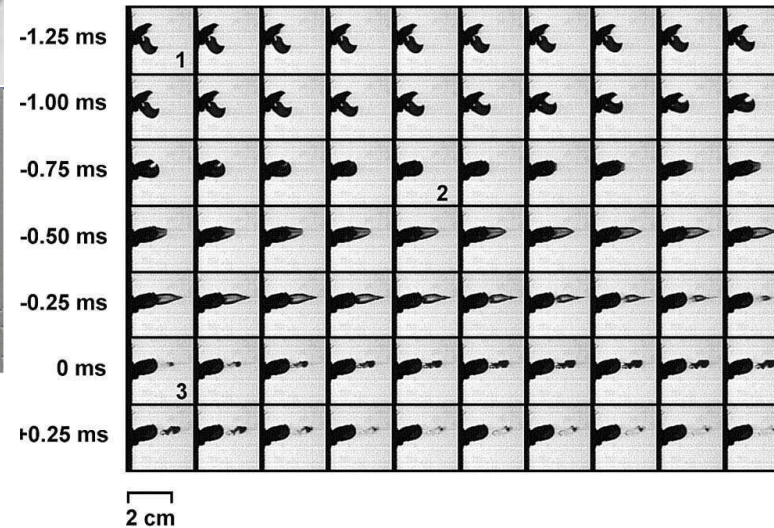
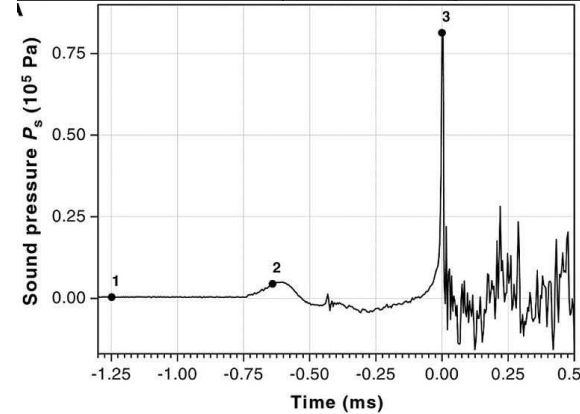
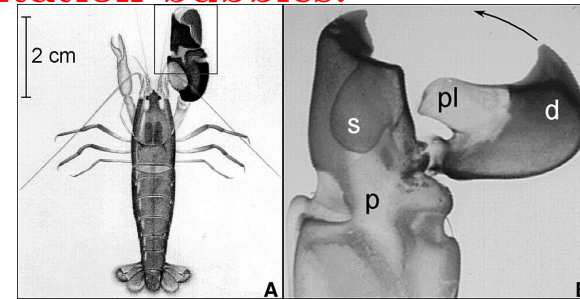

A “Conventional” Neutrino Horn

If desire secondary pions with $E_\pi \lesssim 0.5$ GeV (neutrino factories), a high- Z target is favored, but for $E_\pi \gtrsim 1$ GeV (“conventional” neutrino beams), low Z is preferred.

A conventional neutrino horn works better with a point target (high- Z).

Small horn ID is desirable \Rightarrow hard to provide target cooling for high beam intensity.

Carbon composite target with He gas cooling (BNL):

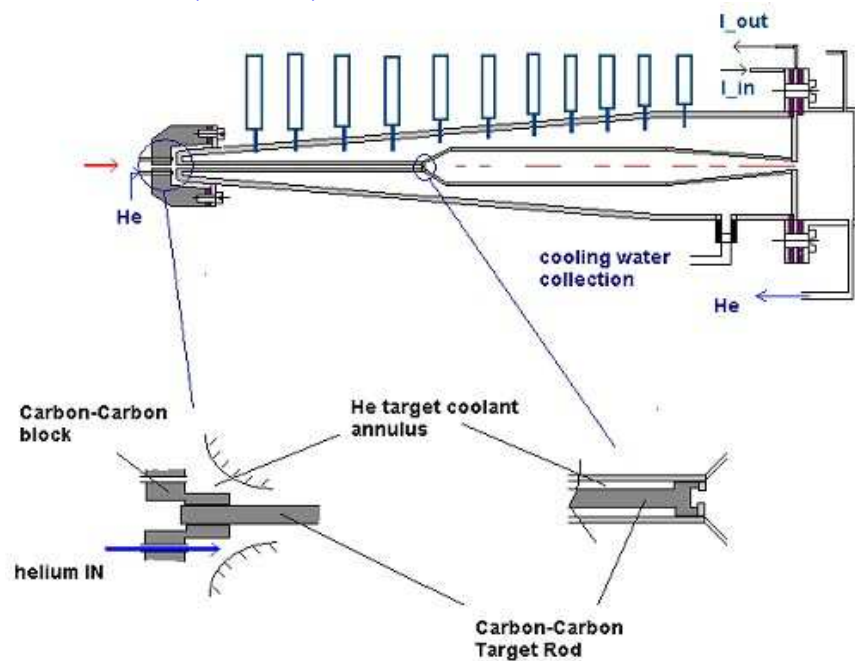

Mercury jet target (CERN SPL):

2.2 GeV
at 4MW
50 Hz
operation

Protons \rightarrow

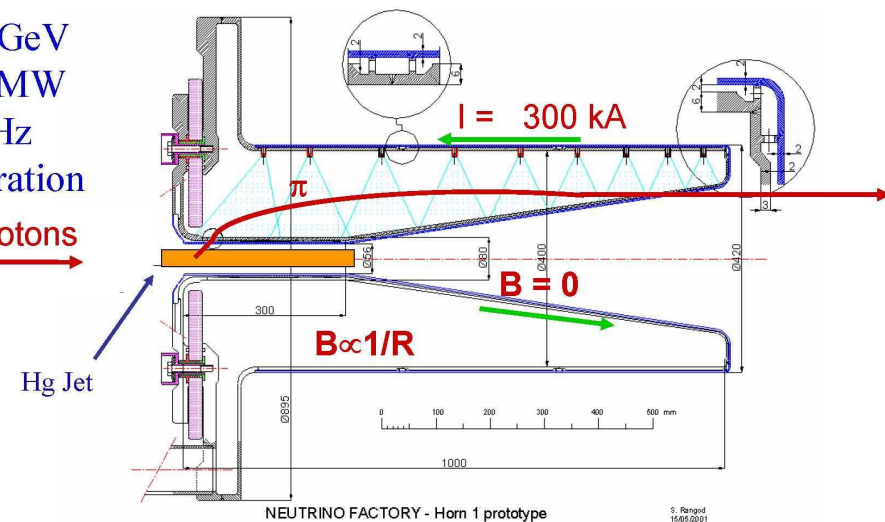

A Solenoidal Targetry System for a Superbeam

- A precursor to a Neutrino Factory is a Neutrino Superbeam based on decay of pions from a multimegawatt proton target station.
- 4 MW proton beams are achieved in both the BNL and FNAL (and CERN) scenarios via high rep rates: $\approx 10^6/\text{day}$.
- Classic neutrino horns based on high currents in conductors that intercept much of the secondary pions will have lifetimes of only a few days in this environment.
- Consider instead a solenoid “horn” with conductors at larger radii than the pions of interest – similar to the Neutrino Factory capture solenoid.
- Pions produced on axis inside the solenoid have zero (canonical) angular momentum, $L_z = r(P_\phi + eA_\phi/c) = 0$,
 $\Rightarrow P_\phi = 0$ on exiting the solenoid.
- If the pion has made exactly 1/2 turn on its helix when it reaches the end of the solenoid, then its initial P_r has been rotated into a pure P_ϕ , $\Rightarrow P_\perp = 0$ on exiting the solenoid,
 \Rightarrow Point-to-parallel focusing.

Narrowband Neutrino Beams via Solenoid Focusing

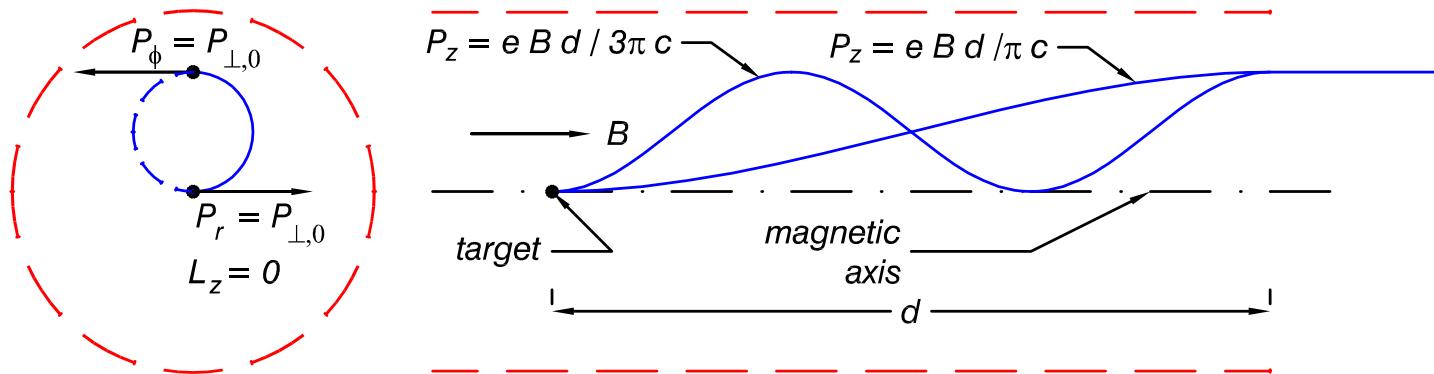

- The point-to-parallel focusing occurs for $P_\pi = eBd/(2n + 1)\pi c$.
- \Rightarrow Narrowband neutrino beams of energies

$$E_\nu \approx \frac{P_\pi}{2} = \frac{eBd}{(2n + 1)2\pi c}.$$

- \Rightarrow Can study several neutrino oscillation peaks at once (Marciano, hep-ph/0108181),

$$\frac{1.27M_{23}^2[\text{eV}^2] L[\text{km}]}{E_\nu[\text{GeV}]} = \frac{(2n + 1)\pi}{2}.$$

- Get both ν and $\bar{\nu}$ at the same time,
 - \Rightarrow Must use detector that can identify sign of μ and e ,
 - \Rightarrow Magnetized liquid argon TPC (astro-ph/0105442).

Other Alternatives

Rotating band target (B. King):

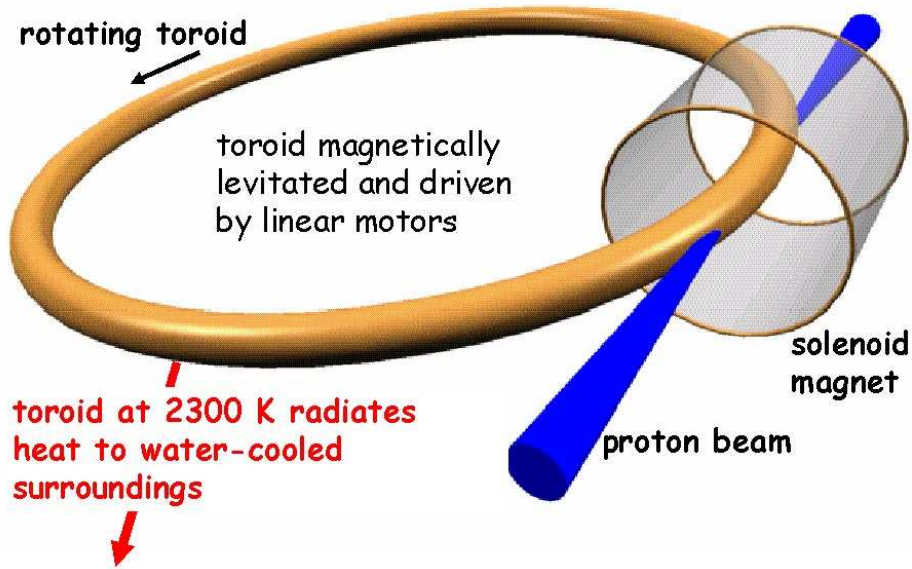

Granular target (P. Sievers):

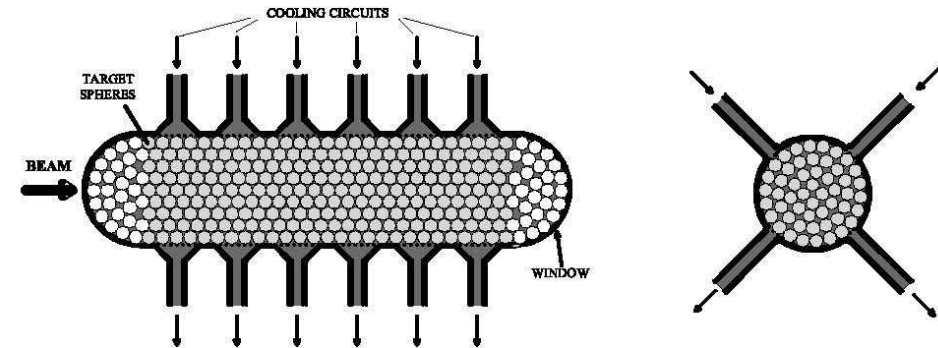

Also can consider multiple targets in multiple beams (B. Autin).

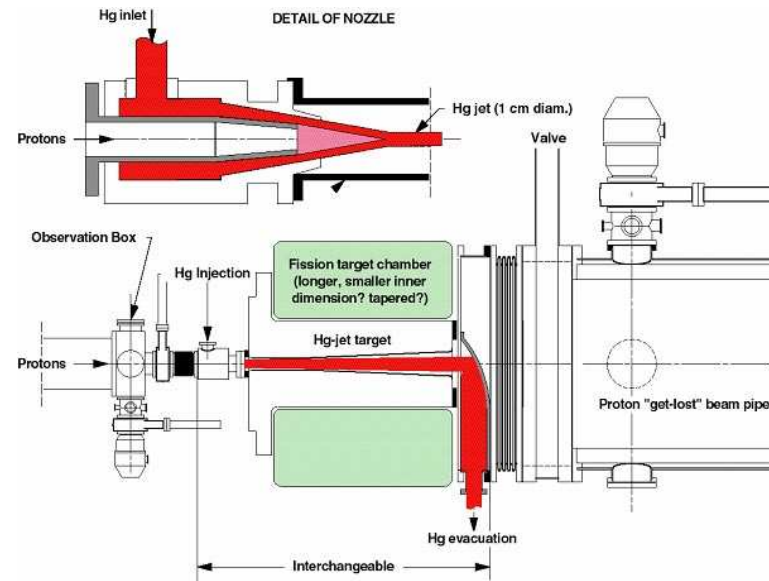
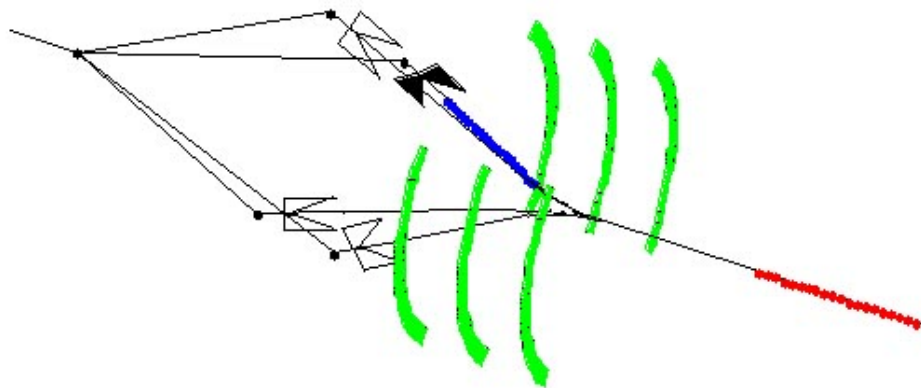

Major Milestones in the Targetry R&D Program

- **Sept. 1998:** Targetry R&D proposal submitted to BNL.
- **Oct. 1999:** BNL E951 approved.
- **Summer 2000:** Conceptual studies of a carbon target + 20-T hybrid solenoid for the 1.5-MW proton beam of Neutrino Factory Feasibility Study 1.
- **Mar.-Apr. 2001:** Tests of solid targets, a mercury “thimble” and a free mercury jet target with 24-GeV protons in the BNL A3 beamline.
- **Spring 2001:** Conceptual studies of mercury jet + 20-T solenoid for the 4-MW proton beam of Neutrino Factory Feasibility Study 2.
- **Aug. 2001:** Mercury “thimble” tests in the 2-GeV ISOLDE proton beam at CERN.
- **May, 2002:** 1st irradiation of solid targets at the BNL BLIP facility.
- **June 2002:** Studies of a mercury jet in a 20-T magnetic field, Grenoble. (A. Fabich Ph.D. thesis, Nov. 2002).

Major Milestones, cont'd.

- **Jan. 2003:** Letter of Intent to J-PARC for targetry R&D in a 50-GeV proton beam.
- **Sept. 2003:** High-Power Targetry workshop, Ronkonkoma, NY.
- **Oct. 2003:** Contract let to CVIP/Everson-Tesla for fabrication of a 15-T pulsed solenoid magnet.
- **Mar. 2004:** 2nd irradiation of solid targets at the BNL BLIP facility.
- **Apr. 2004:** Proposal for studies of a mercury jet + 15-T solenoid + 24-GeV proton beam at CERN.
- **Apr. 2005:** The CERN targetry experiment is approved as nToF11.

Thermal Shock is a Major Issue in High-Power Pulsed Beams

When beam pulse length t is less than target radius r divided by speed of sound v_{sound} , beam-induced pressure waves (thermal shock) are a major issue.

Simple model: if $U =$ beam energy deposition in, say, Joules/g, then the instantaneous temperature rise ΔT is given by

$$\Delta T = \frac{U}{C},$$

where $C =$ heat capacity in Joules/g/K.

The temperature rise leads to a strain $\Delta r/r$ given by

$$\frac{\Delta r}{r} = \alpha \Delta T = \frac{\alpha U}{C},$$

where $\alpha =$ thermal expansion coefficient.

The strain leads to a stress P (= force/area) given by

$$P = E \frac{\Delta r}{r} = \frac{E \alpha U}{C},$$

where E is the modulus of elasticity.

In many metals, the tensile strength obeys $P \approx 0.002E$,

$\alpha \approx 10^{-5}$, and $C \approx 0.3 \text{ J/g/K}$, in which case

$$U_{\max} \approx \frac{PC}{E\alpha} \approx \frac{0.002 \cdot 0.3}{10^{-5}} \approx 60 \text{ J/g}.$$

How Much Beam Power Can a Solid Target Stand?

How many protons are required to deposit 60 J/g in a material? What is the maximum beam power this material can withstand without cracking, for a 10-GeV beam at 10 Hz with area 0.1 cm^2 .

Ans. If we ignore “showers” in the material, we still have dE/dx ionization loss, of about 1.5 MeV/g/cm^2 .

Now, $1 \text{ MeV} = 1.6 \times 10^{-13} \text{ J}$, so 60 J/g requires a proton beam intensity of $60/(1.6 \times 10^{-13}) = 10^{15}/\text{cm}^2$.

Then, $P_{\max} \approx 10 \text{ Hz} \cdot 10^{10} \text{ eV} \cdot 1.6 \times 10^{-19} \text{ J/eV} \cdot 10^{15}/\text{cm}^2 \cdot 0.1 \text{ cm}^2$
 $\approx 1.6 \times 10^6 \text{ J/s} = 1.6 \text{ MW}$.

Solid targets are viable up to about 1.5 MW beam power!

Window Tests (BNL: $5e12$ ppp, 24 GeV, 100 ns)

Aluminum, Ti90Al6V4, Inconel 708, Havar, instrumented with fiberoptic strain sensors.

Good agreement between data and ANSYS models.

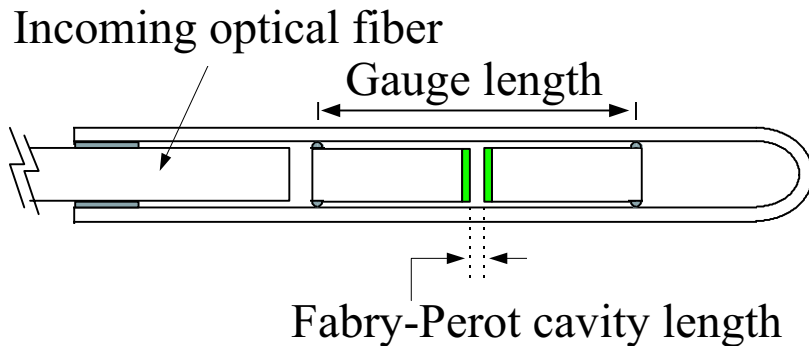
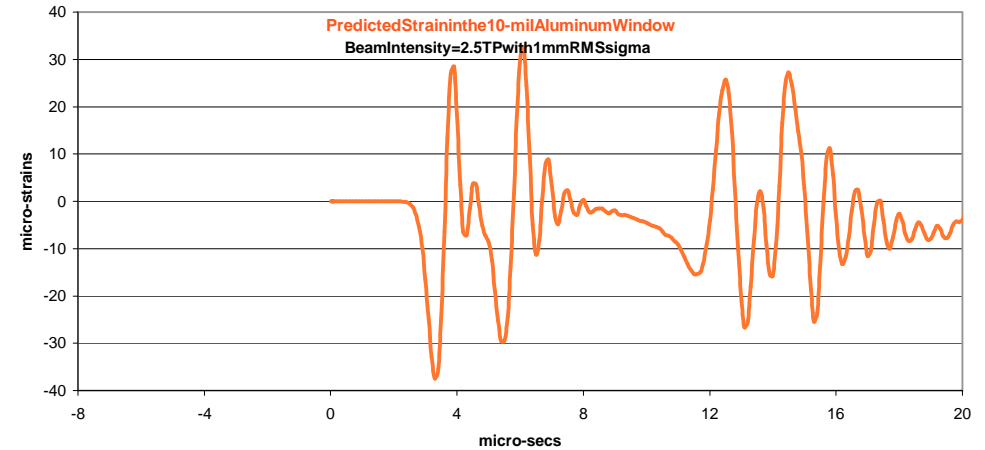
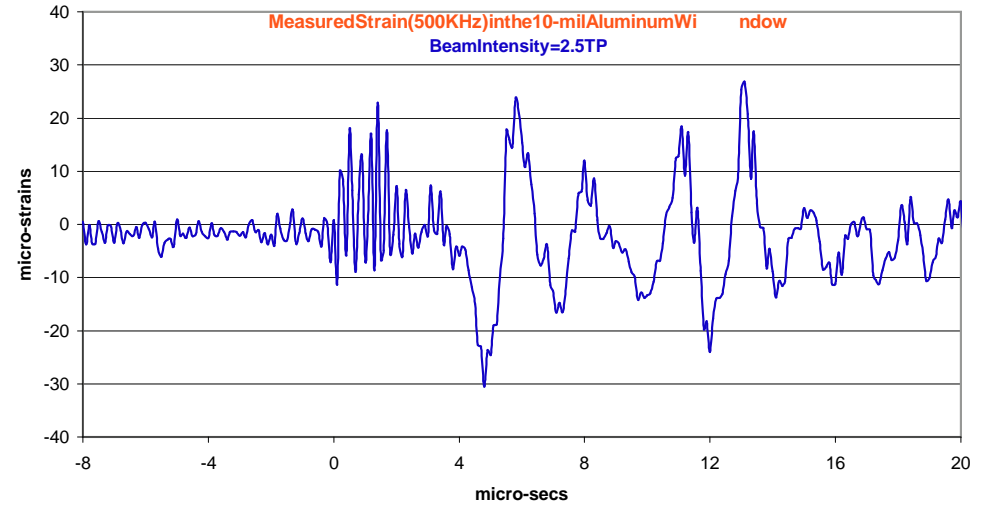
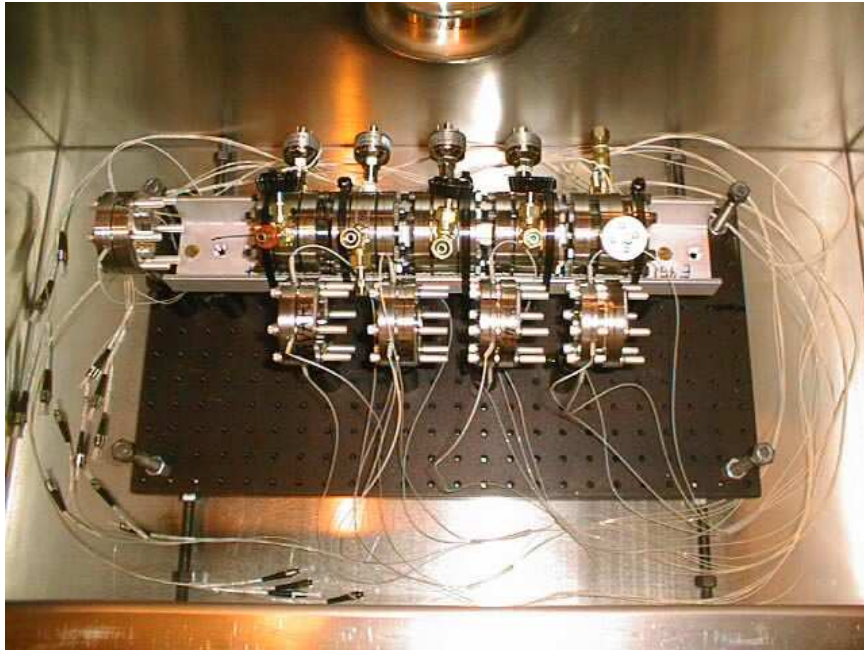

A Carbon Target is Feasible at 1-MW Beam Power

A carbon-carbon composite with near-zero thermal expansion is largely immune to beam-induced pressure waves.

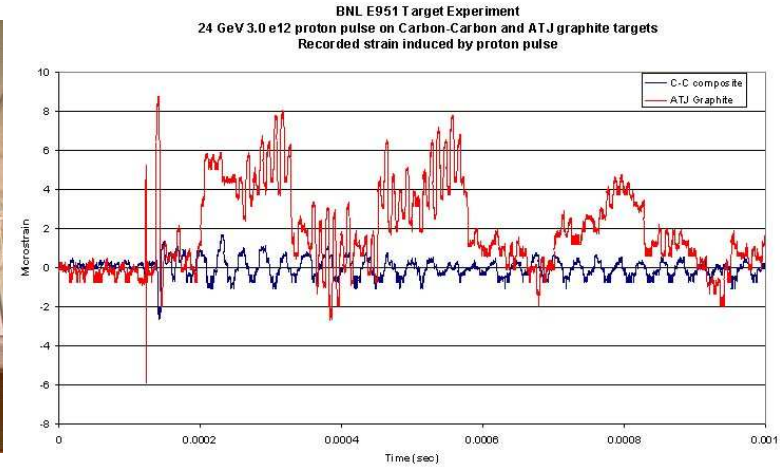

A carbon target in vacuum sublimates away in 1 day at 4 MW.

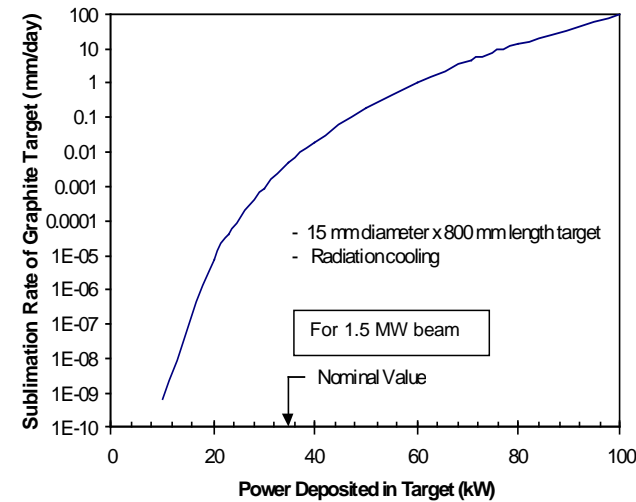

Sublimation of carbon is in a helium atmosphere (J. Haines, ORNL).

Radiation damage is limiting factor: ≈ 12 weeks at 1 MW.

Effects of Radiation on SuperInvar

(H. Kirk, P. Thieberger, N. Simos, BNL)

SuperInvar has a very low coefficient of thermal expansion (CTE),
 ⇒ Resistant to “thermal shock” of a proton beam.

However, irradiation at the BNL BLIP facility show that the CTE increases rapidly with radiation dose.

CTE *vs.* dose ⇒

SuperInvar is made stronger by moderate radiation doses (like many materials).

Yield strength *vs.* dose ⇒

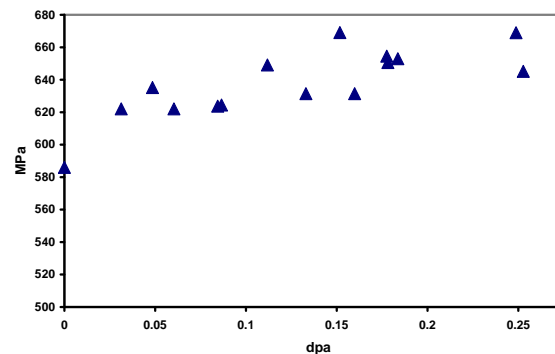
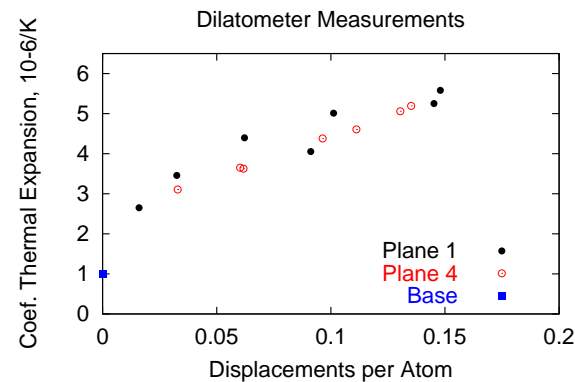
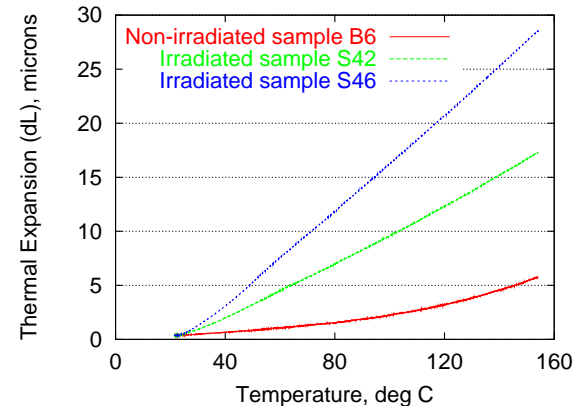

New Round of Solid Target Irradiation Studies

Are “high performance” alloys still high-performance after irradiation?

Materials irradiated at the BNL BLIP, March 2004:

1. Vascomax 350 (high strength steel for bandsaw target).
2. Ti90-Al6-V4 (titanium alloy for linear collider positron target).
3. Toyota “gum” metal (low-thermal expansion titanium alloy).
4. AlBeMet (aluminum/beryllium alloy).
5. IG-43 Graphite (baseline for J-PARC neutrino production target).
6. Carbon-carbon composite (3-d weave with low-thermal expansion).

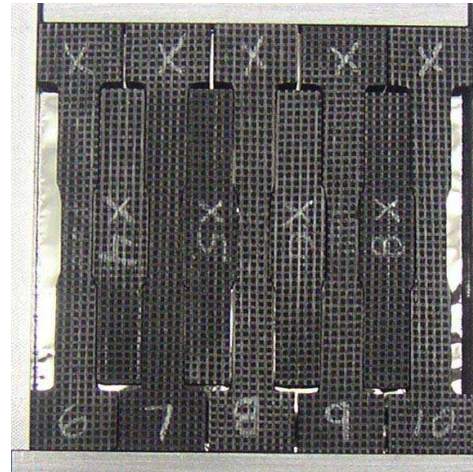
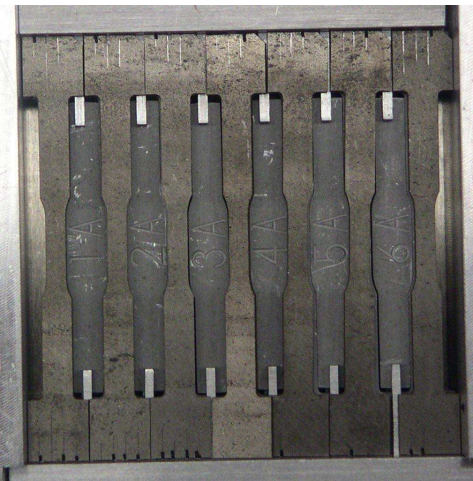
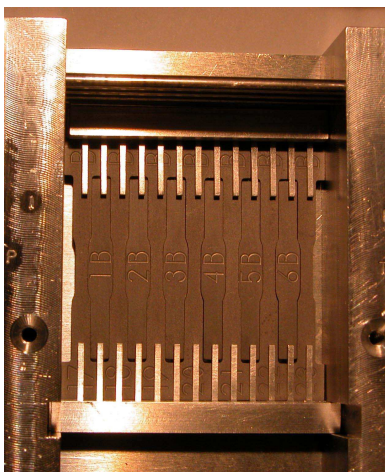

Annealing of the CTE by High-Temperature Cycles

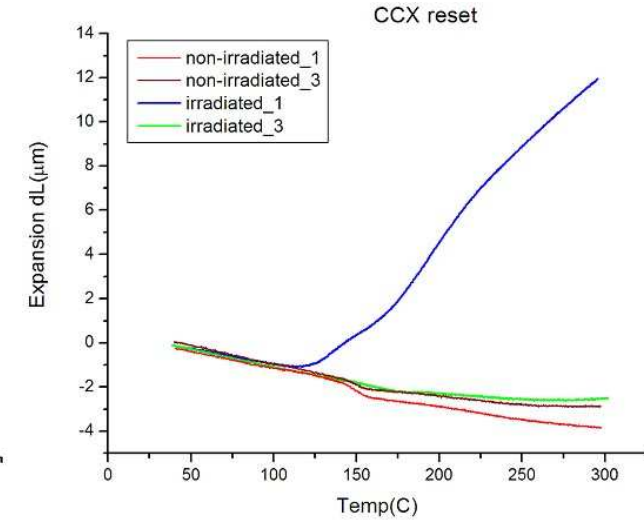
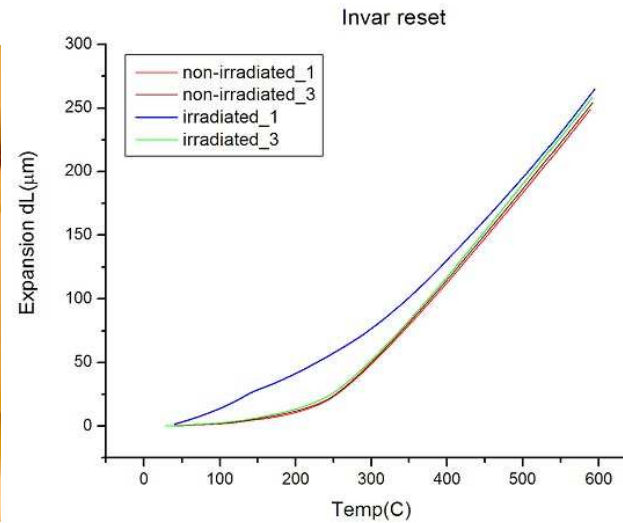
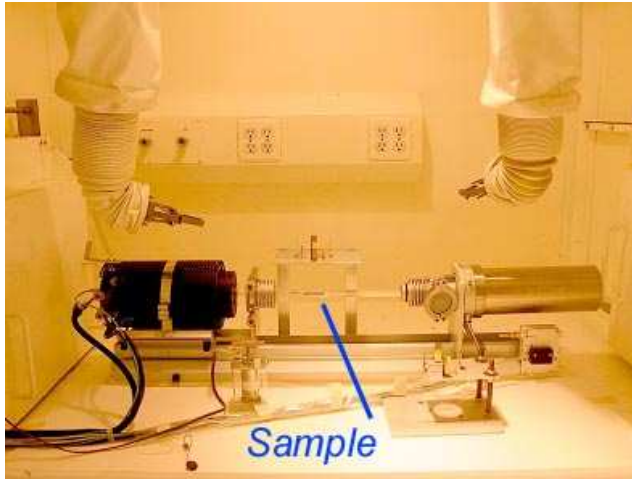

The Linseis dilatometer can now be cycled to 600 C (in the hot cell).

Thermal cycling of superinvar above 500 C anneals the radiation damage of the CTE.

The 3-d weave of carbon-carbon composite also showed deterioration of its CTE due to radiation, but the CTE was restored by thermal cycling to 300 C.

Small effects of radiation damage, and also of thermal annealing, seen in the Toyota titanium superalloy (“gum metal”).

Solid Target R&D at RAL

PPARC Award – 550k (J.R.J. Bennett *et al.*)

- Measure mechanical strength characteristics of tantalum under shock conditions at 2000C.
- Model the shock for different geometries, using codes from the explosives community.
- In-beam tests with proton at ISIS and/or ISOLDE.

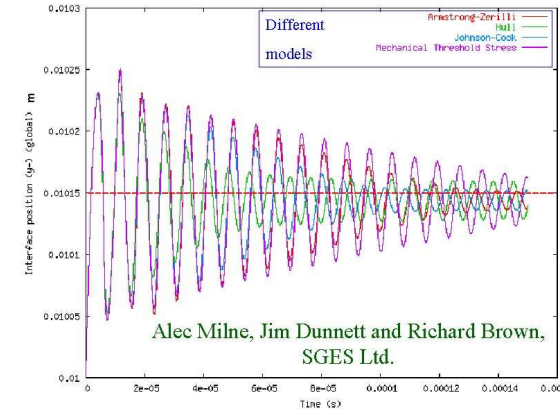

The radius of the bar versus time for a single pulse. Temperature jump from 300 to 2300 K.

Future: a proposal to the European Union Sixth Framework Programme (FP6) for a “Design Study for Neutrino Factory Target R&D” will be submitted in 2005.

Lead: R. Edgecock (RAL).

Rotating band option:

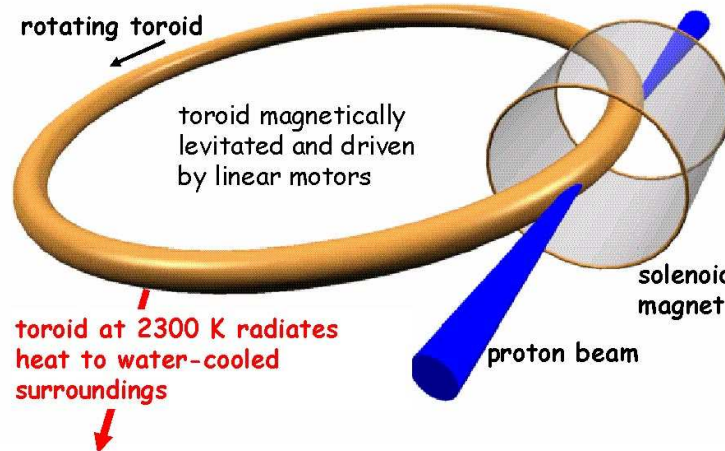

POWER DISSIPATION

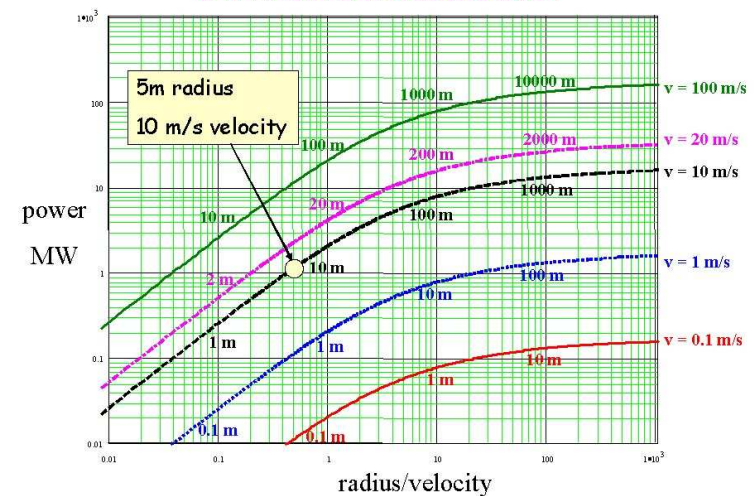

Passive Mercury Target Tests (BNL and CERN)

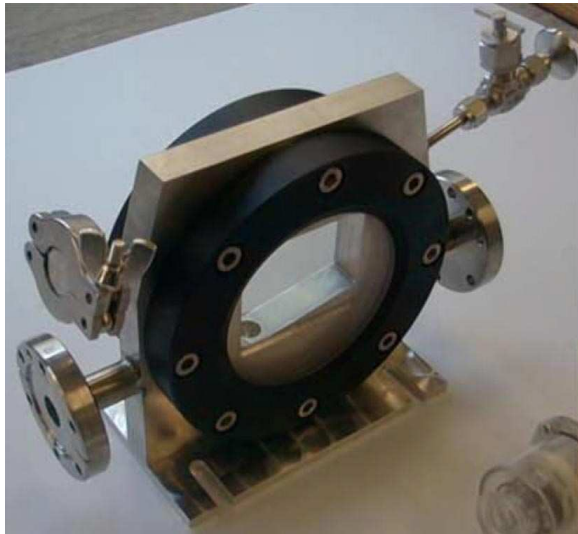

Exposures of $25 \mu\text{s}$ at
 $t = 0, 0.5, 1.6, 3.4 \text{ msec}$,
 $\Rightarrow v_{\text{splash}} \approx 20 - 40 \text{ m/s}$:

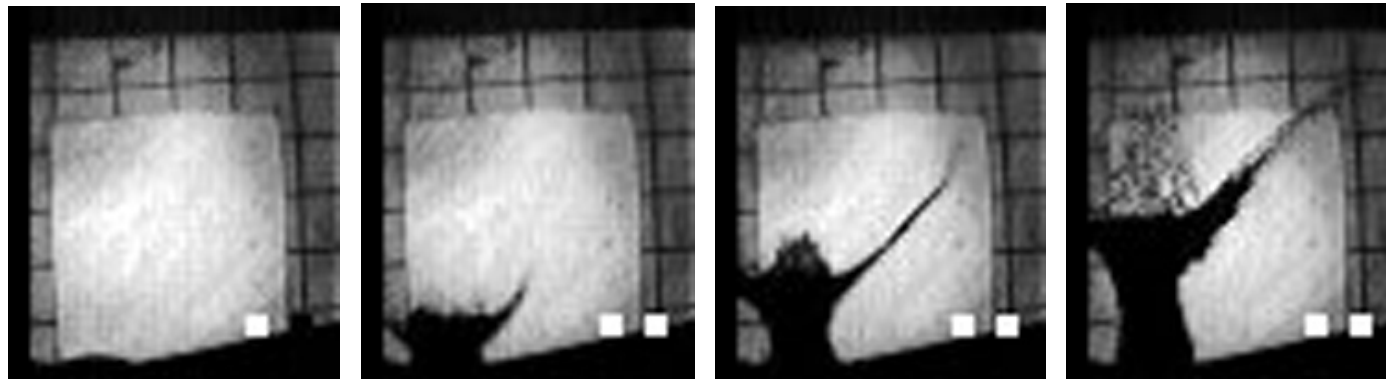

Two pulses of $\approx 250 \text{ ns}$ give larger dispersal velocity only if separated by less than $3 \mu\text{s}$.

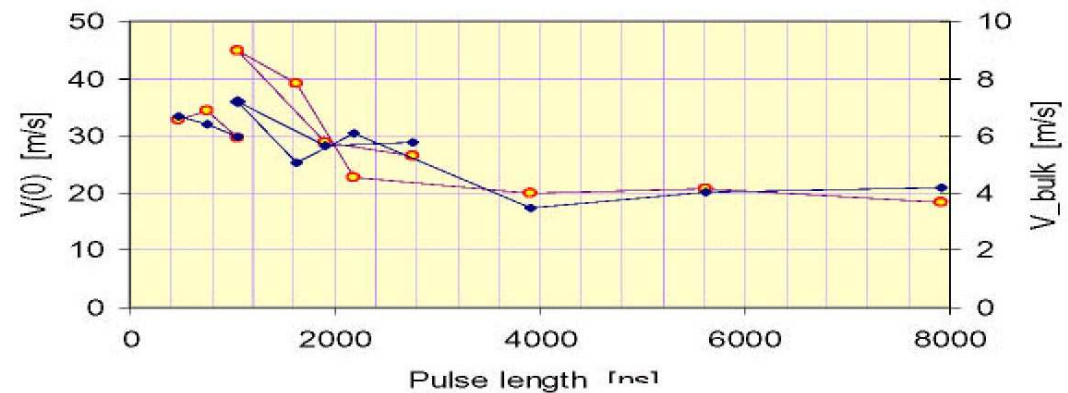

Studies of Proton Beam + Mercury Jet (BNL)

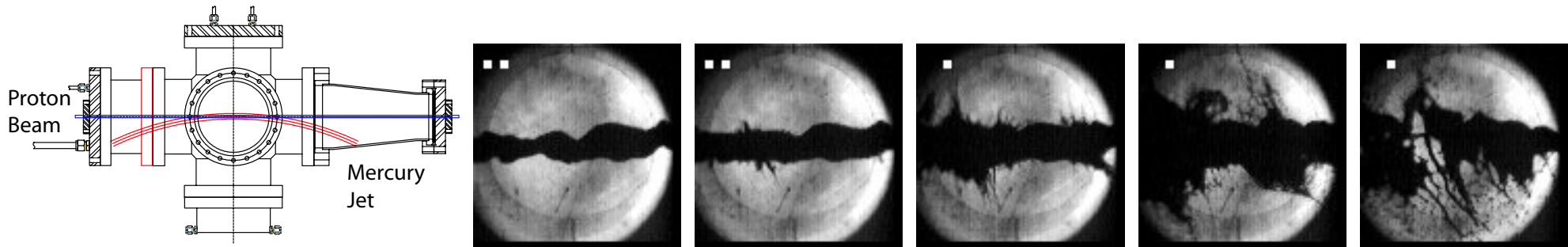

1-cm-diameter Hg jet in $2e12$ protons at $t = 0, 0.75, 2, 7, 18$ ms.

Model (Sievers):

$$v_{\text{dispersal}} = \frac{\Delta r}{\Delta t} = \frac{r\alpha\Delta T}{r/v_{\text{sound}}} = \frac{\alpha U}{C} v_{\text{sound}} \approx 50 \text{ m/s}$$

for $U \approx 100 \text{ J/g}$.

Data: $v_{\text{dispersal}} \approx 10 \text{ m/s}$ for $U \approx 25 \text{ J/g}$.

$v_{\text{dispersal}}$ appears to scale with proton intensity.

The dispersal is not destructive.

Filaments appear only $\approx 40 \mu\text{s}$ after beam,

\Rightarrow after several bounces of waves, or v_{sound} very low.

Tests of a Mercury Jet in a 20-T Magnetic Field

(CERN/Grenoble, A. Fabich, Ph.D. Thesis)

Eddy currents may distort the jet as it traverses the magnet.

Analytic model suggests little effect if jet nozzle inside field.

4 mm diam. jet,
 $v \approx 12$ m/s,
 $B = 0, 10, 20$ T.

⇒ Damping of surface-tension waves (Rayleigh instability).

Will the beam-induced dispersal be damped also?

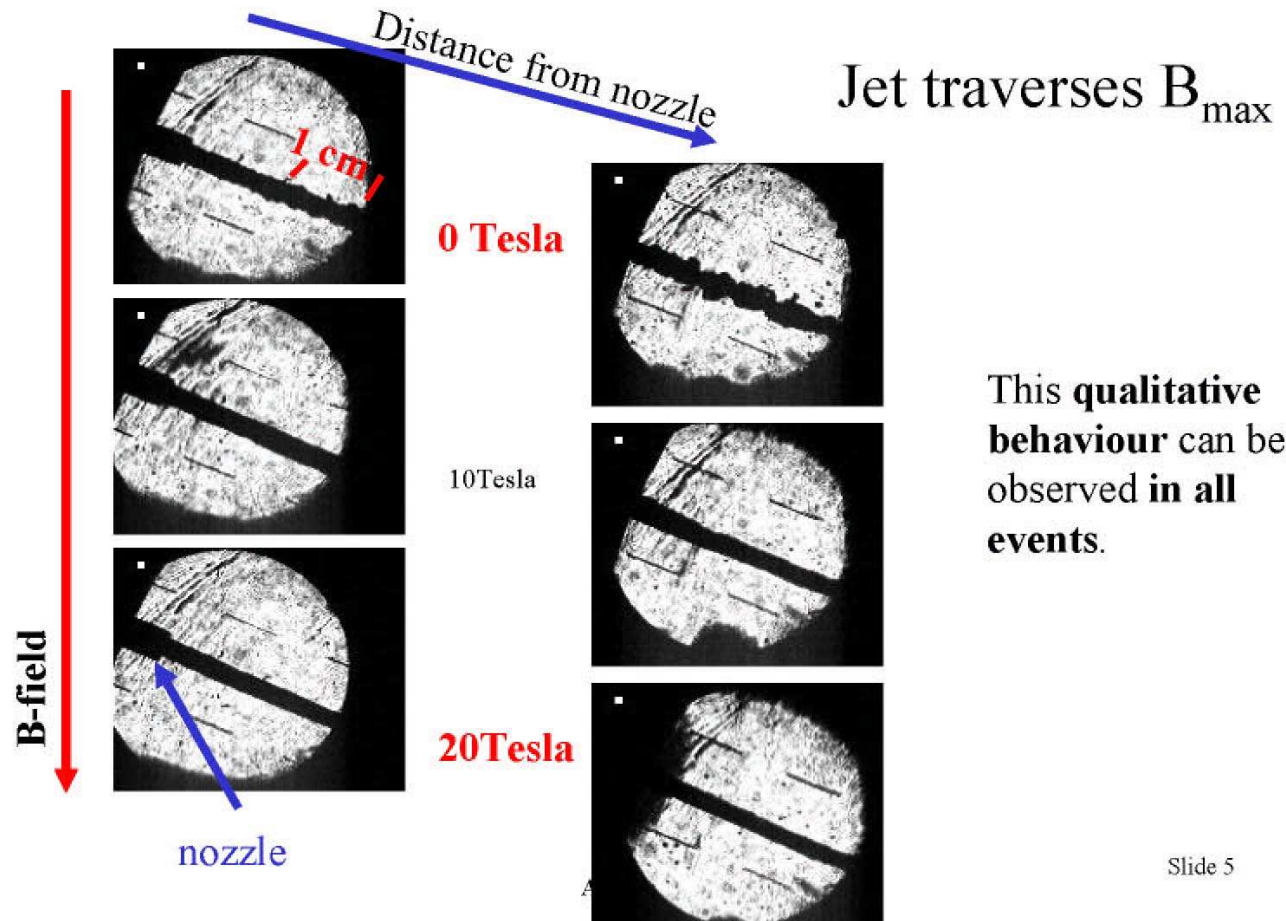

Slide 5

Laser-Induced Breakup of a Water Jet

(J. Lettry, CERN)

A laser pulse is sent down the axis of a water jet, creating internal cavitation bubbles.

A focused laser pulse leads to localized dispersion of the jet, with fine fine-grained filamentation (as predicted by Samulyak).

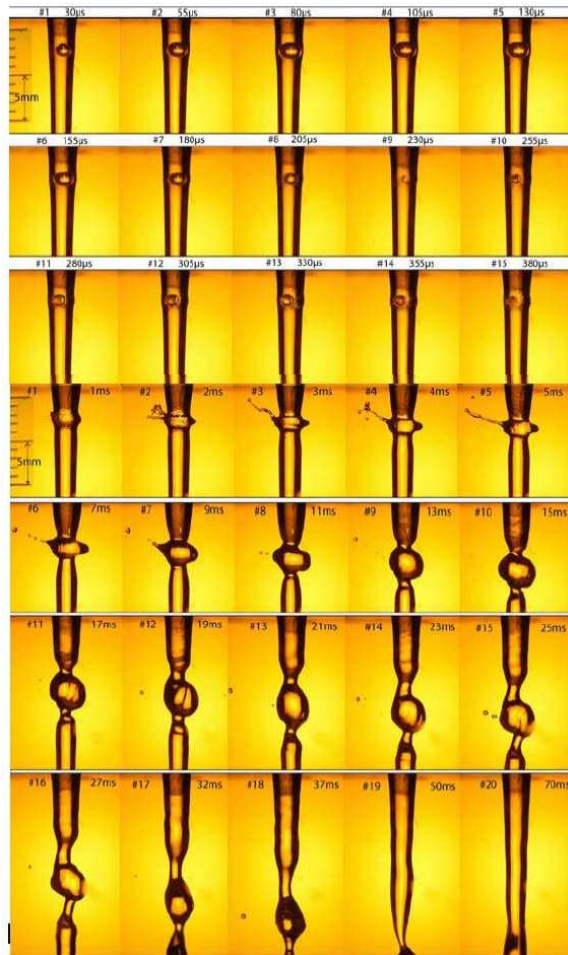

Water jet ripples generated by a
 8 mJ Laser cavitation bubble



Computational Magnetohydrodynamics

(R. Samulyak, Y. Pyrkarpatsky)

Use equation of state that supports negative pressures, but gives way to cavitation.

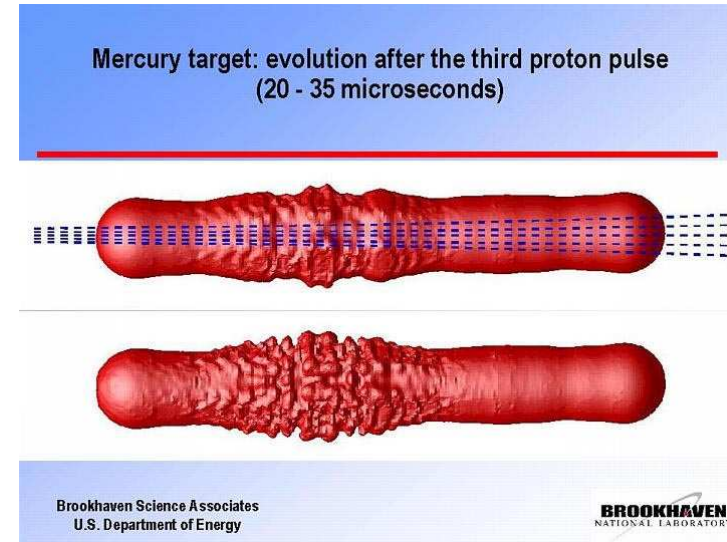

Thimble splash at 0.24, 0.48, 0.61, 1.01 μs

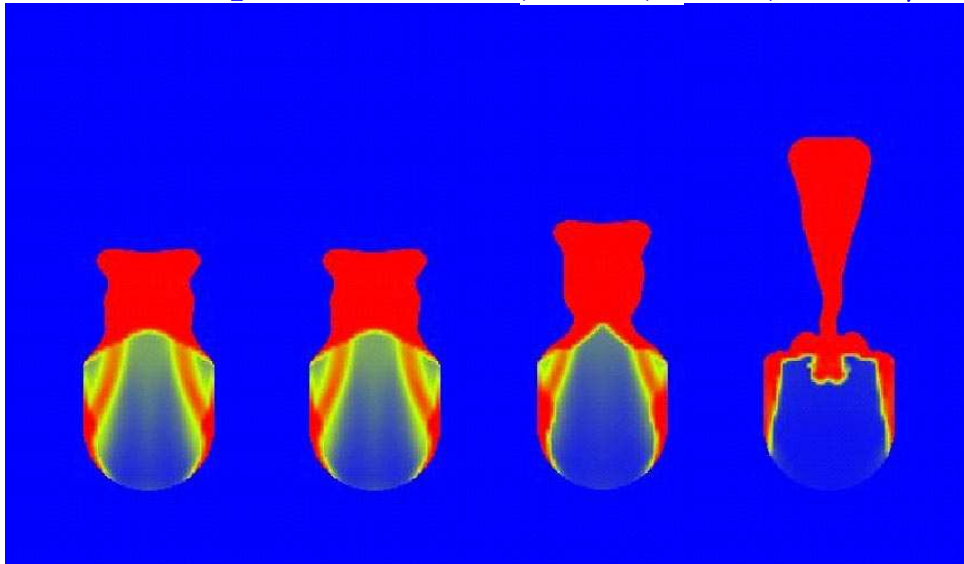

Magnetic damping of beam-induced filamentation:

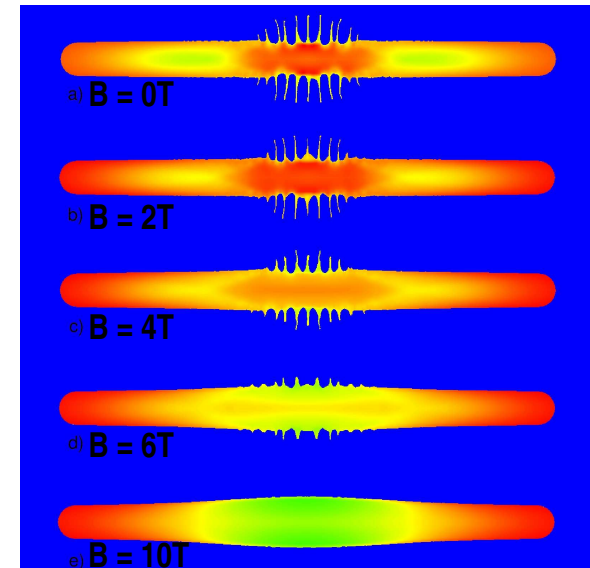

Target System Support Facility

Extensive shielding and remote handling capability.

[P. Spampinato *et al.*,
Neutrino Factory Feasibility Study 2
 (2001)]

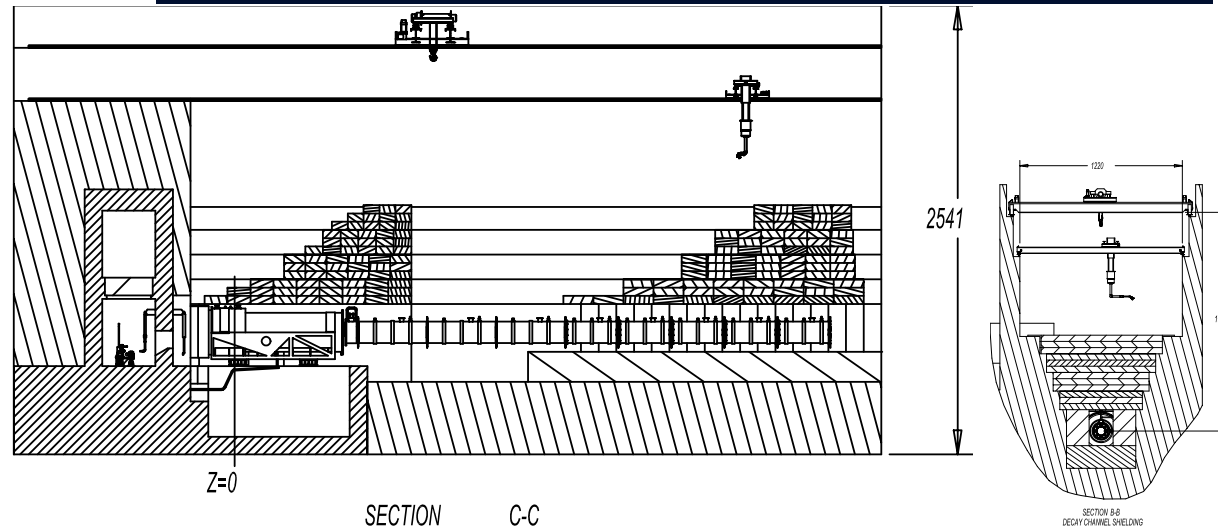
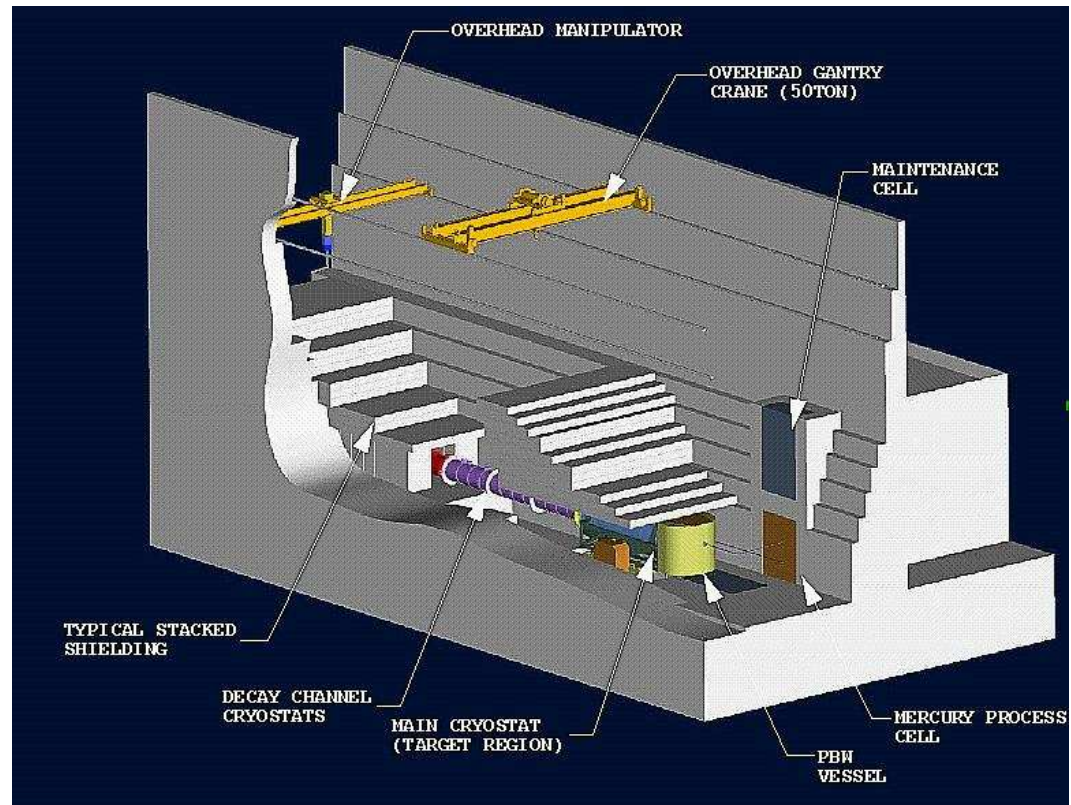

Lifetime of Components in the High Radiation Environment

Component	Radius (cm)	Dose/yr (Grays/ 2×10^7 s)	Max allowed Dose (Grays)	1 MW Life (years)	4 MW life (years)
Inner shielding	7.5	5×10^{10}	10^{12}	20	5
Hg containment	18	10^9	10^{11}	100	25
Hollow conductor coil	18	10^9	10^{11}	100	25
Superconducting coil	65	5×10^6	10^8	20	5

Some components must be replaceable.

[MARS calculations (N. Mokhov, FNAL):]

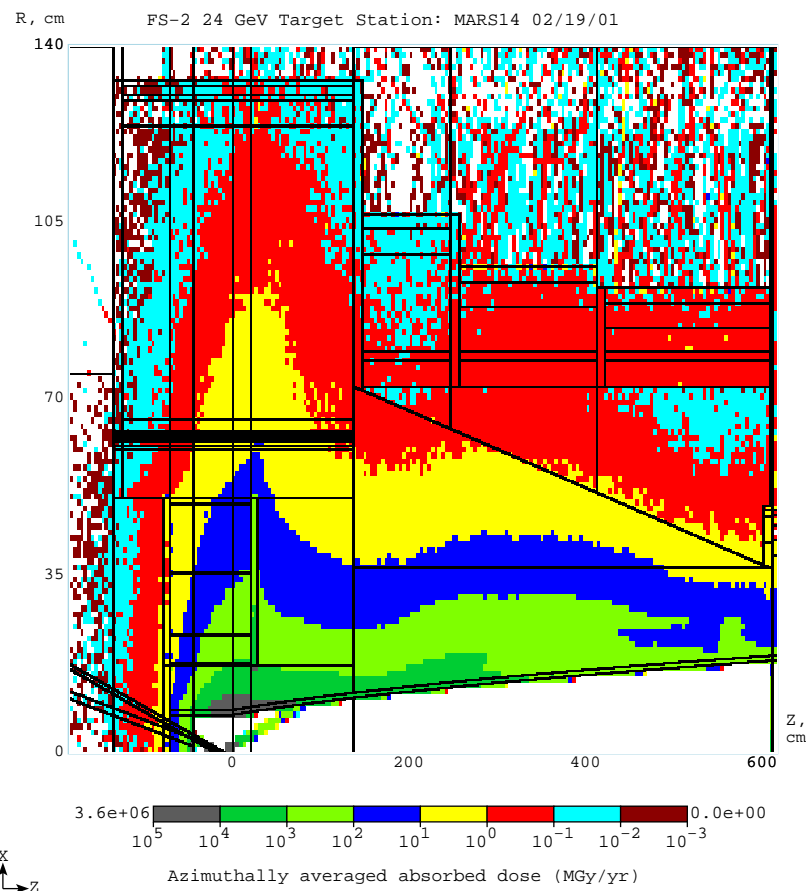

What Have We Learned?

- **Solid targets are viable in pulsed proton beams of up to 1-2 MW.**
- **Engineered materials with low coefficients of thermal expansion are desirable, but require further qualification for use at high radiation dose.**
- **A mercury jet appears to behave well in a proton beam at zero magnetic field, and in a high magnetic field without proton beam.**

Issues for Further Targetry R&D

- **Continue numerical simulations of MHD + beam-induced effects.**
- **For solid targets, study radiation damage – and issues of heat removal from solid metal targets (carbon/carbon, Toyota Ti alloy, bands, chains, *etc.*).**
- **Proof-of-Principle test of an intense proton beam with a mercury jet inside a high-field magnet.**
 1. **MHD effects in a prototype target configuration.**
 2. **Magnetic damping of mercury-jet dispersal.**
 3. **Beam-induced damage to jet nozzle – in the magnetic field.**

Proof-of-Principle of Liquid Jet + Magnet + Proton Beam

- **Foreseen since inception of the targetry R&D program in 1997.**
- **Active planning since 2002, after success of separate beam + jet, and magnet + jet studies.**
- **Diminished option to perform the test at BNL.**
- **Long-term option to perform the test at J-PARC
(LOI submitted Jan 2003).**
- **Good opportunity at CERN in 2007 (LOI submitted Nov 2003).**
- **Contract awarded in late 2003 for fabrication of the 15-T pulsed solenoid coil + cryostat.**
- **Proposal submitted to CERN in Apr 2004 by a collaboration from BNL, CERN, KEK, ORNL, Princeton and RAL.**

CERN-INTC-2004-016
 INTC-P-186
 26 April 2004

A Proposal to
 the ISOLDE and Neutron Time-of-Flight Experiments
 Committee

Studies of a Target System for
 a 4-MW, 24-GeV Proton Beam

J. Roger J. Bennett¹, Luca Bruno², Chris J. Densham¹, Paul V. Drumm¹,
 T. Robert Edgecock¹, Adrian Fabich², Tony A. Gabriel³, John R. Haines³,
 Helmut Haseroth², Yoshinari Hayato⁴, Steven J. Kahn⁵, Jacques Lettry², Changguo Lu⁶,
 Hans Ludewig⁵, Harold G. Kirk⁵, Kirk T. McDonald⁶, Robert B. Palmer⁵,
 Yarema Prykarpatsky⁵, Nicholas Simos⁵, Roman V. Samulyak⁵, Peter H. Thieberger⁵,
 Koji Yoshimura⁴

Spokespersons: H.G. Kirk, K.T. McDonald
 Local Contact: H. Haseroth

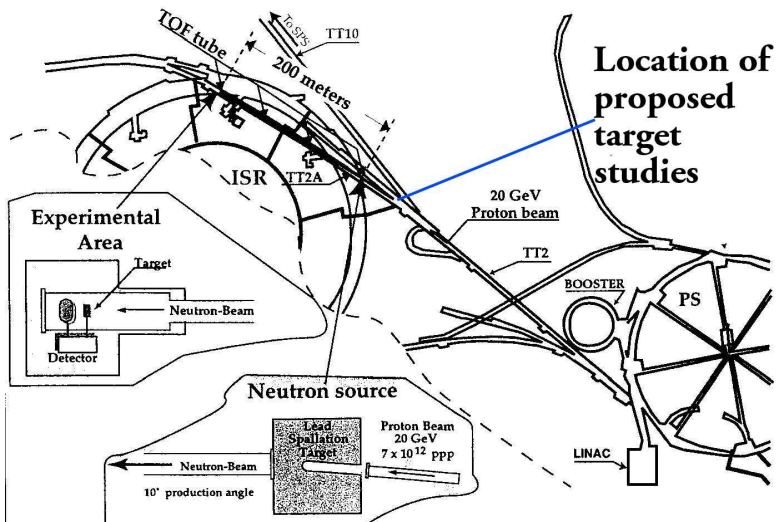
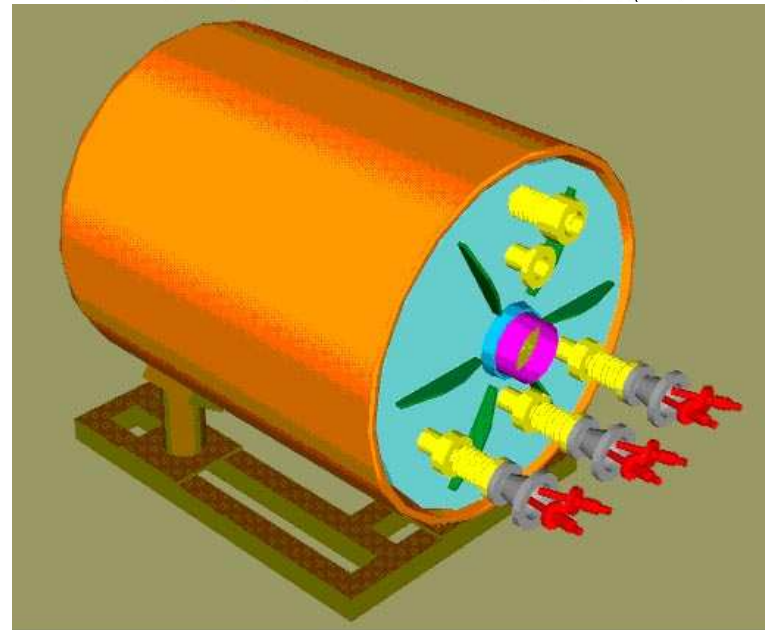
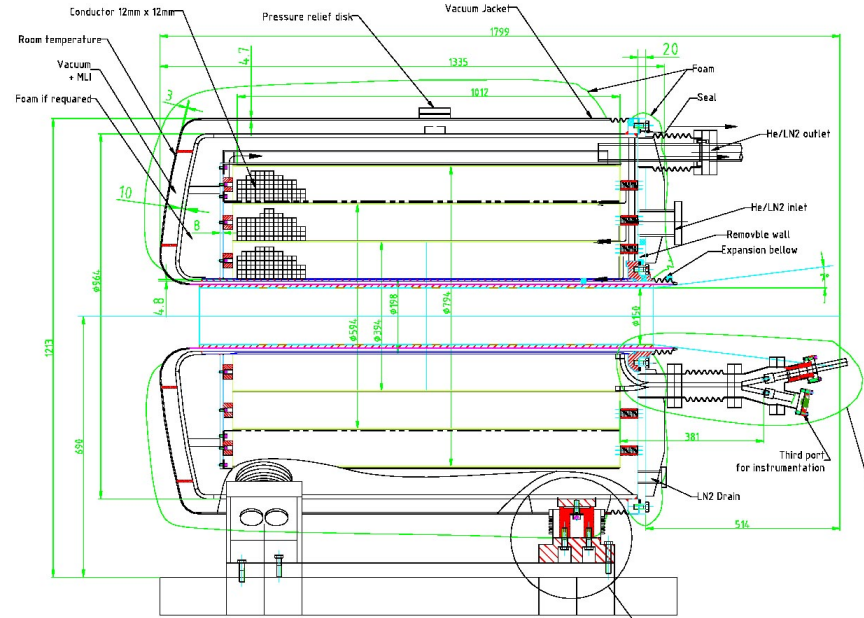

Approved on 5 April 2005 as nToF11; to run in 2007.

Experiment To Be Performed in the CERN TT2A Tunnel (Presently the Neutron Time-of-Flight Beamline)

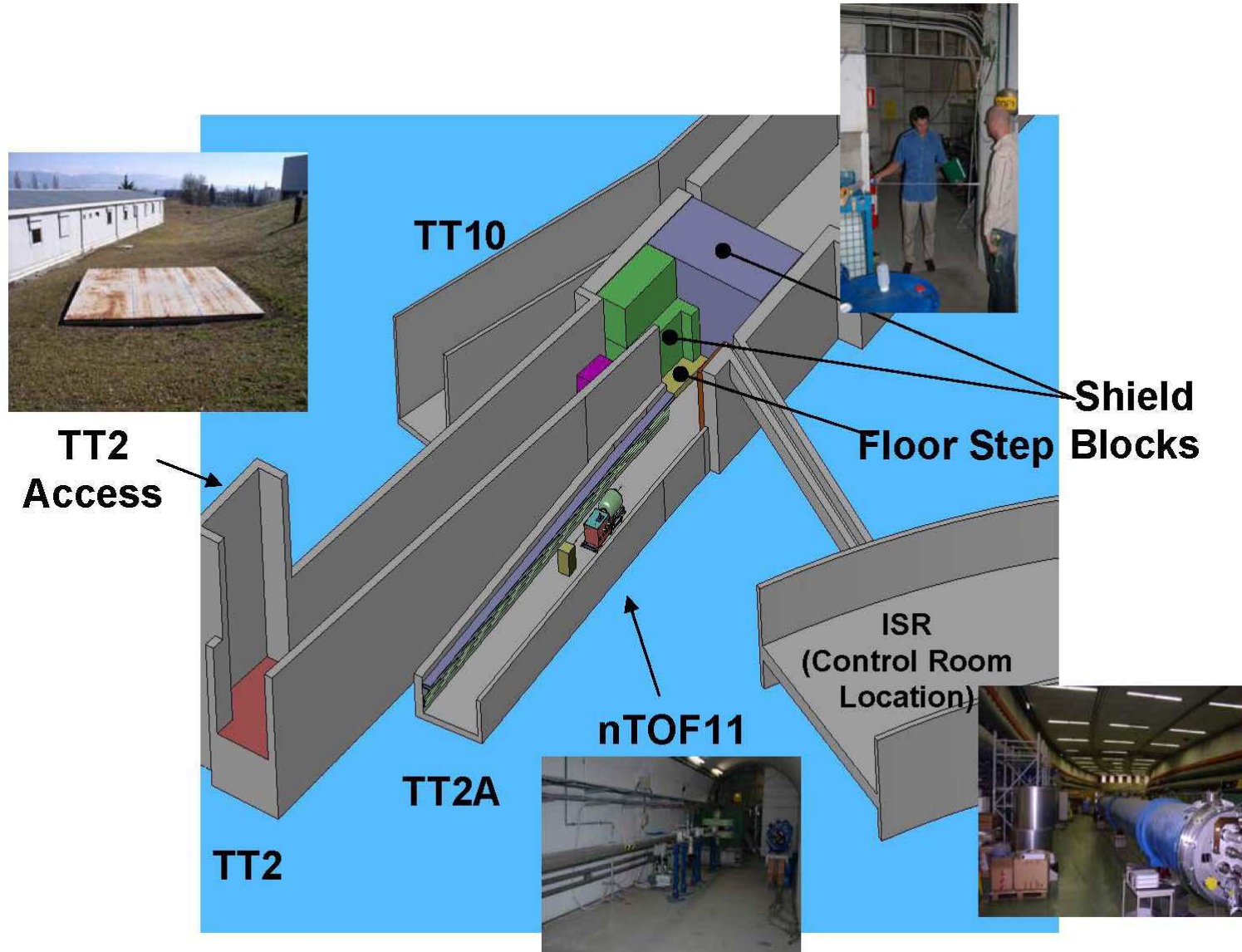

Coil/Cryostat Fabrication at CVIP & Everson-Tesla

Design: P. Titus, R. Weggel (MIT)

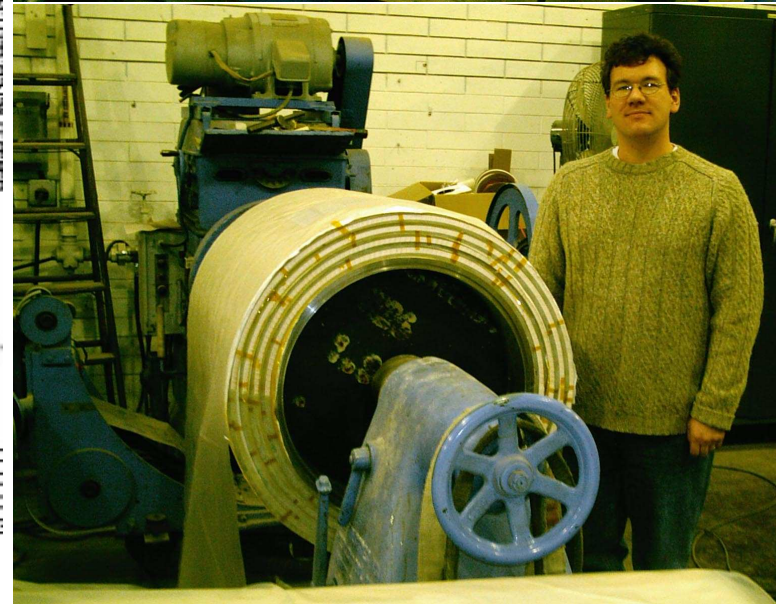
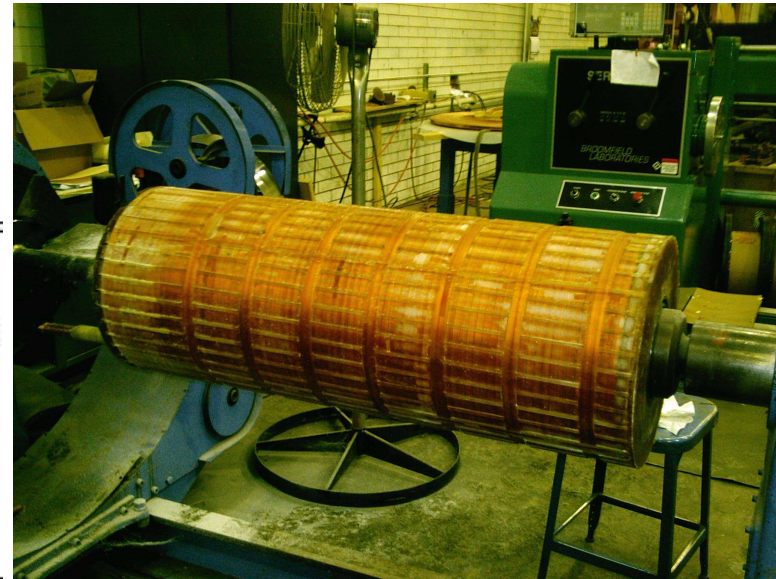
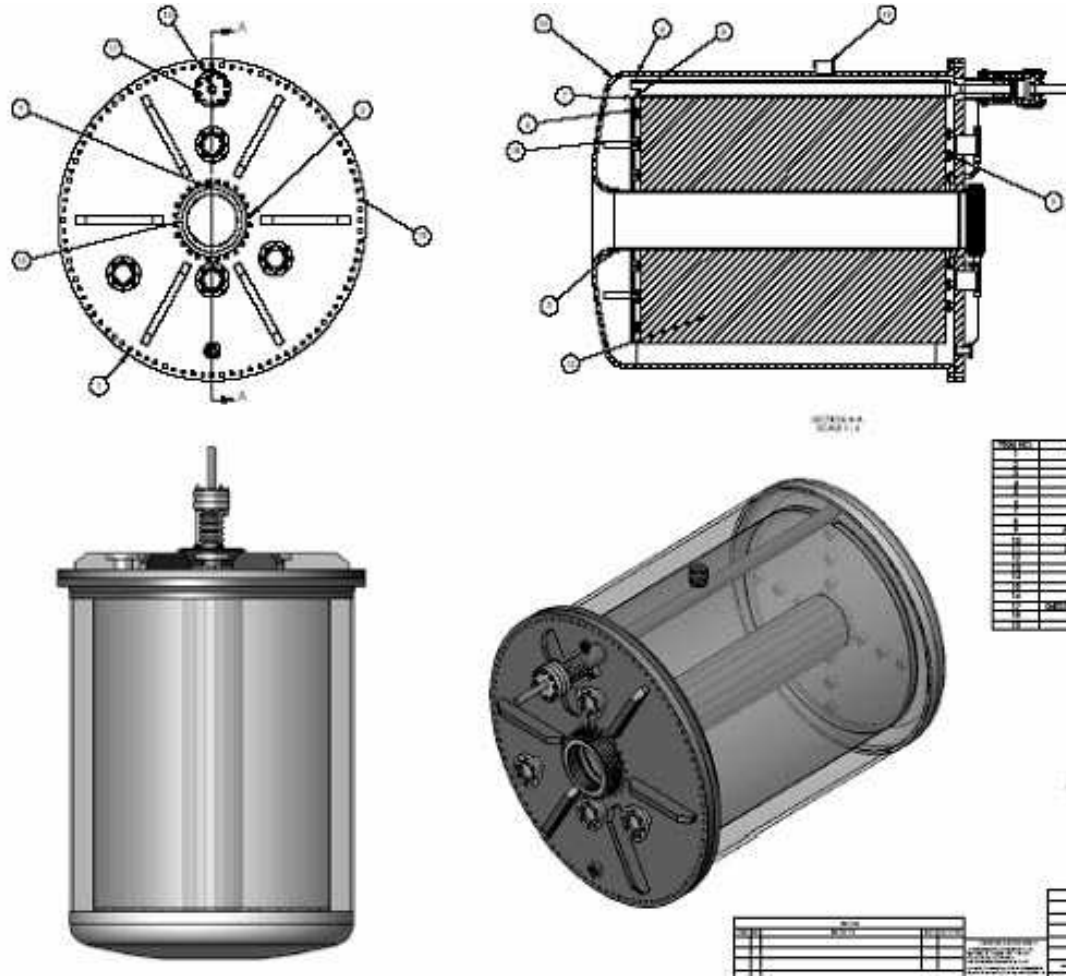

The LN₂ Cryogenic System

- **CARN/RAL responsibility (F. Haug, Y. Ivanyschenko)**
- **Operate magnet at 80K.**
- **Purge magnet of LN₂ before each beam pulse to minimize air activation.**
- **Recycle purged LN₂ via a buffer tank.**
- **Vent warm LN₂/gas to TT10 tunnel.**

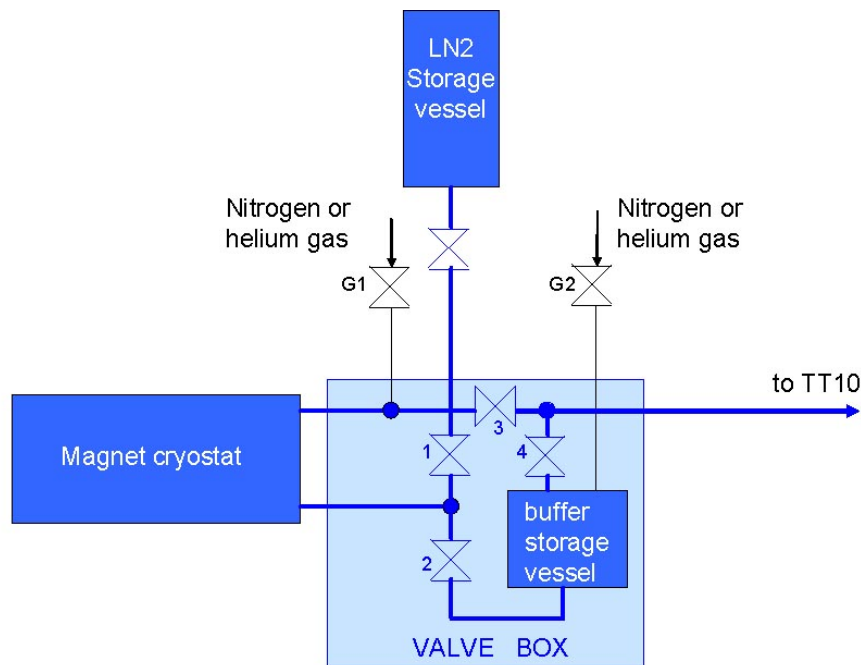

Schematic diagram of the cryogenic system

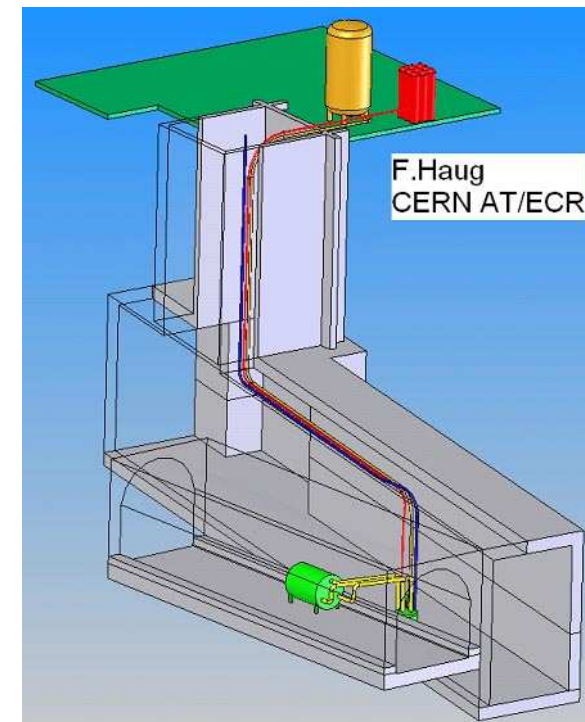

5-MW Power Supply

Rebuild an 8-MW supply decommissioned from the SPS transfer line.



(Lights will dim slightly all over CERN when this supply is pulsed.)

Mercury Jet System

(V. Graves/P. Spampinato, ORNL)

“Syringe” pump system delivers 1.6 l/s of mercury in a 20-m/s jet for 10-20 s.

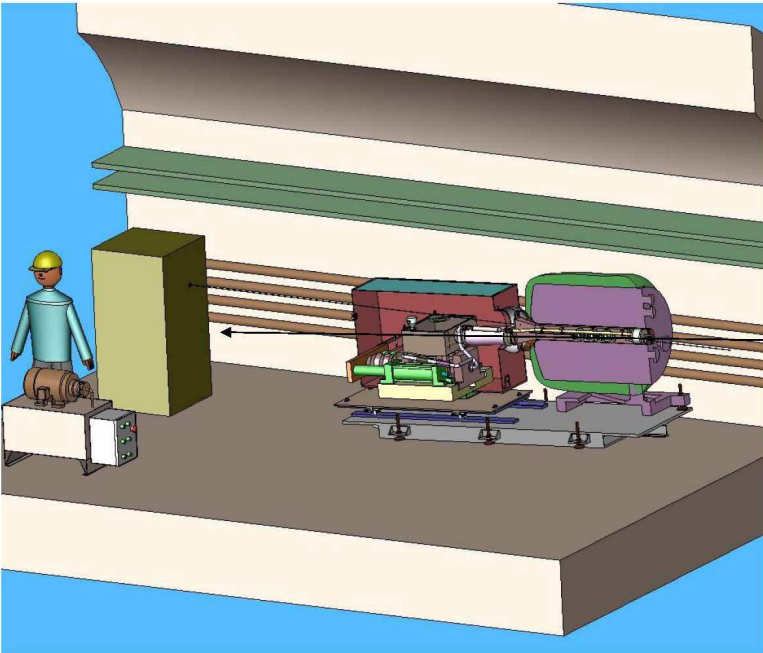

24 GeV
 Protons

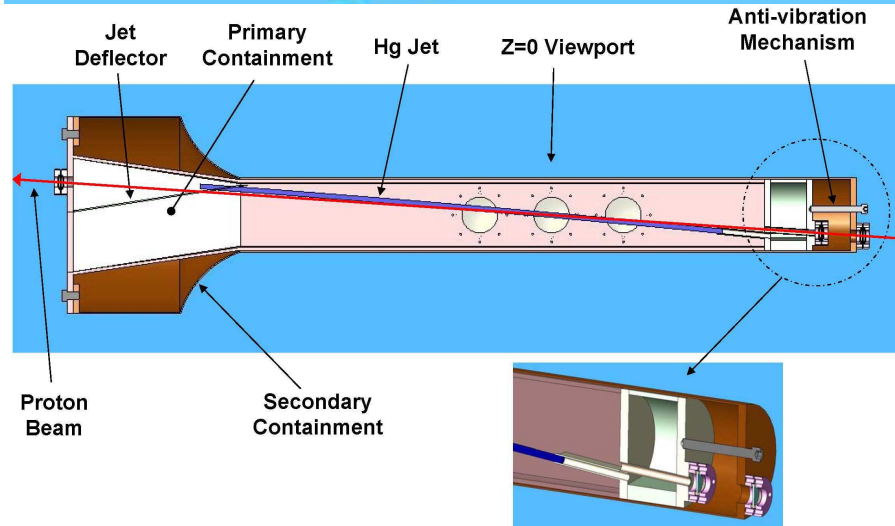
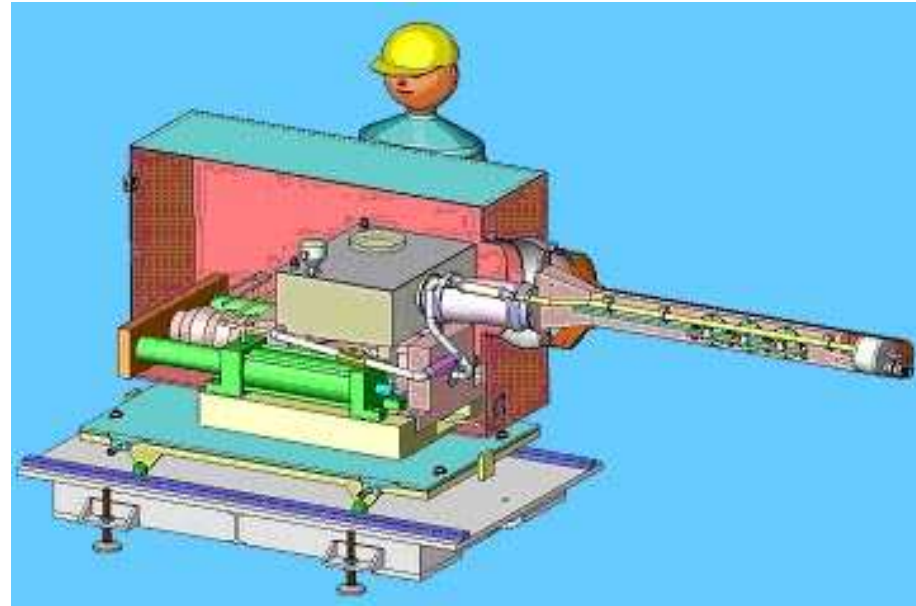

Optical Diagnostics

(T. Tsang, BNL)

Variant of E-951 optics.

Fiber bundle delivers laser light to 45° mirror.

Light is retroreflected by spherical mirror.

Fiber bundle carries shadow image to remote camera.

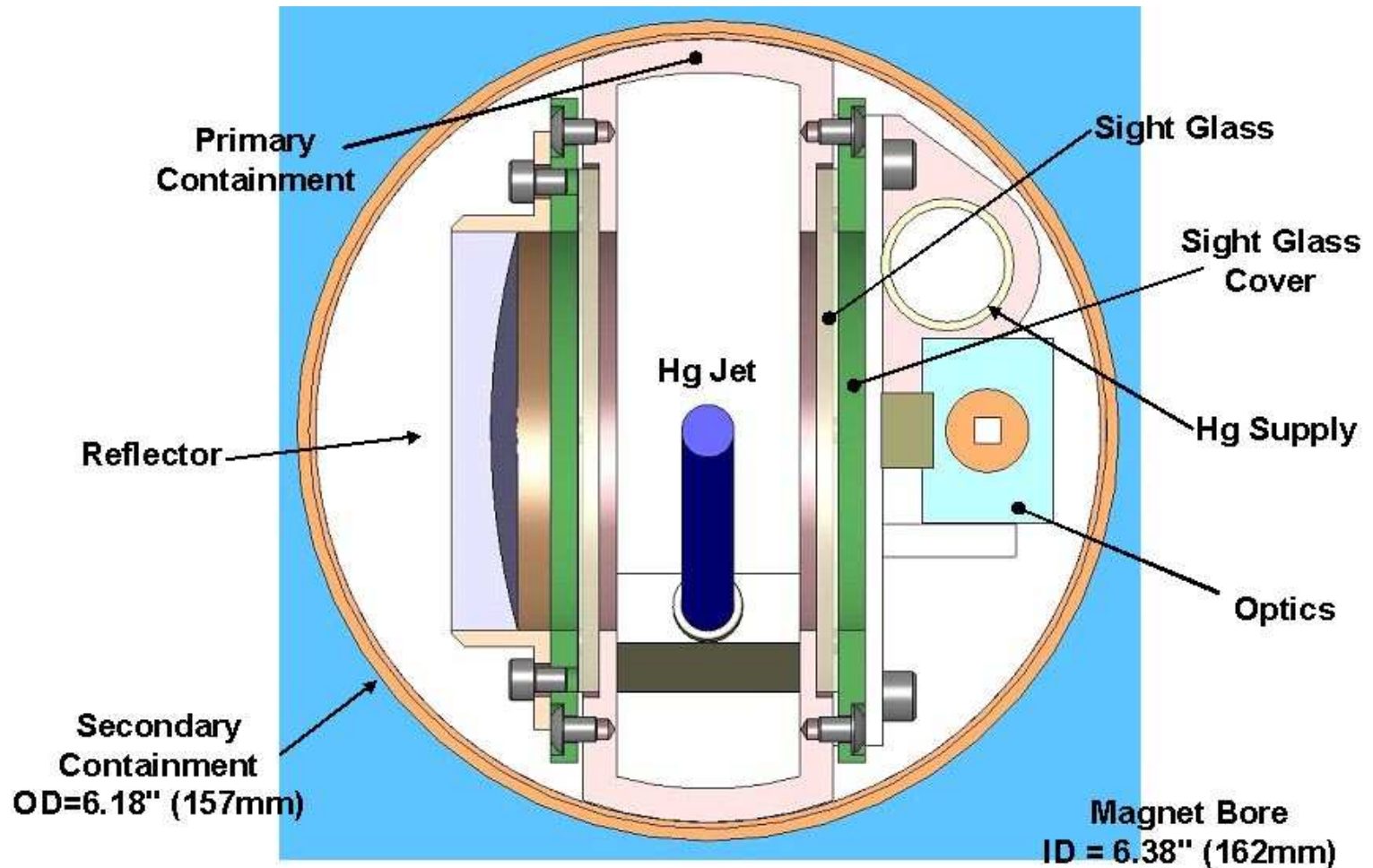

nToF11 Run Plan

- **24-GeV proton beam.**
- **Up to 28×10^{12} protons per 2-s spill.**
- **Can vary bunch spacing from 0.5-10 μ s.**
- **Can also study bunches 20 ms apart (50-Hz equivalent).**
- **Proton beam spot with $\sigma_r = 1.5$ mm \Rightarrow 180 J/g deposited.**
- **1-cm-diameter mercury jet, with velocity 20 m/s.**
- **Magnetic axis 100 mrad from mercury jet axis.**
- **\sim 100 beam/magnet pulses, with 30 min between pulses.**
- **Each pulse is a separate experiment.**

Summary

- Improved performance of High Power Targets is a cost-effective path to improved performance of future muon and neutrino beams.
- Relevant R&D on high-performance solid and liquid targets is being carried out by an international collaboration.
- We are poised to perform the needed proof-of-principle test of a liquid jet + magnet + beam (CERN experiment nToF11).