

# Physics at the High-Energy Frontier with Colliding Beams of Muons

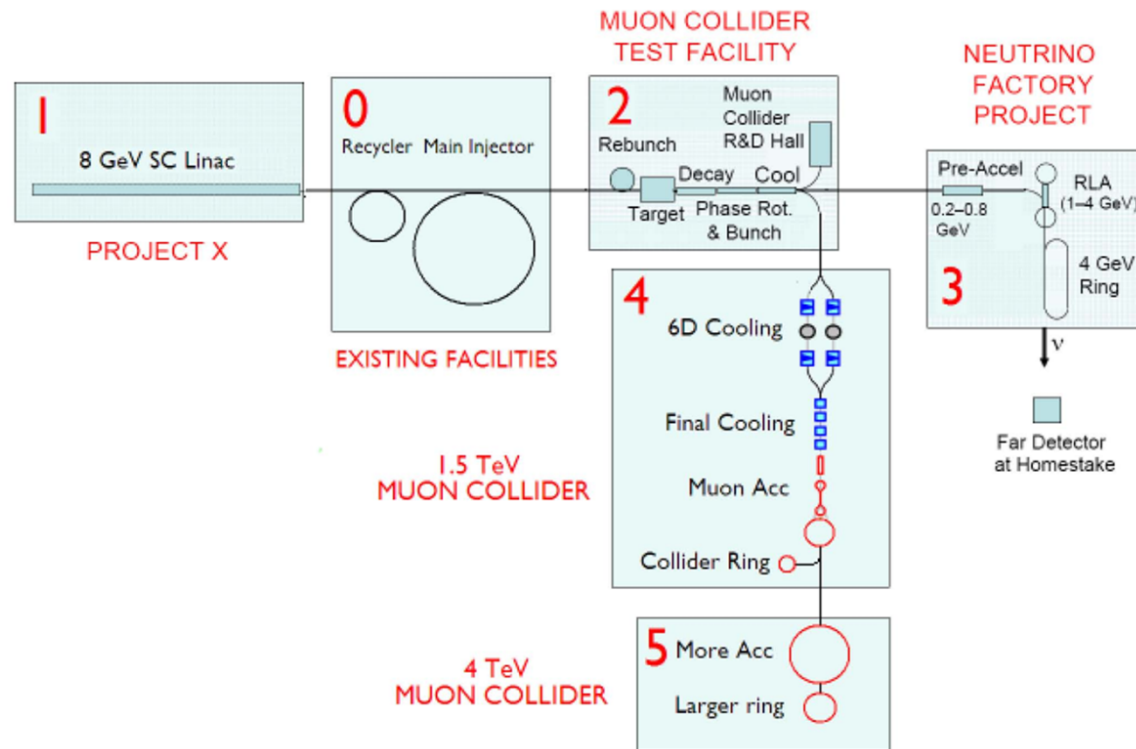

K. McDonald

*Princeton U.*

(Aug 22, 2011)

*UT Knoxville*

(Aug 23, 2011)

*ORNL*



# Atoms

Speculation that we and our world is made from smaller "particles" is very ancient:

Mochus (Phoenicia) [identified by Newton as Moses]

Leucippis, Democritus, Epicurus, ..., among the Greeks

Lucretius among the Romans

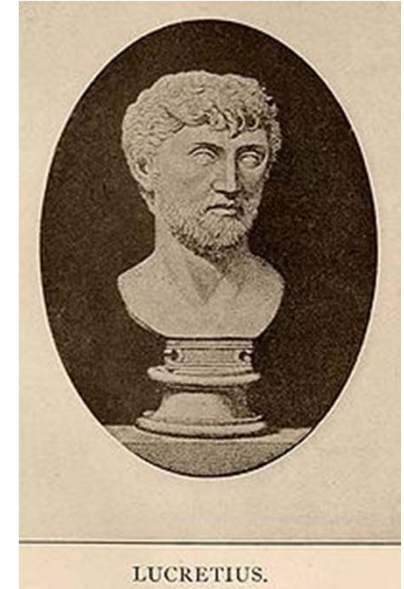
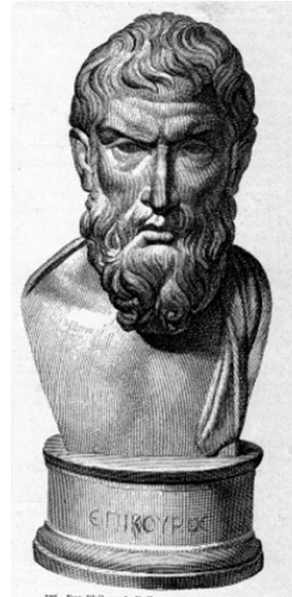
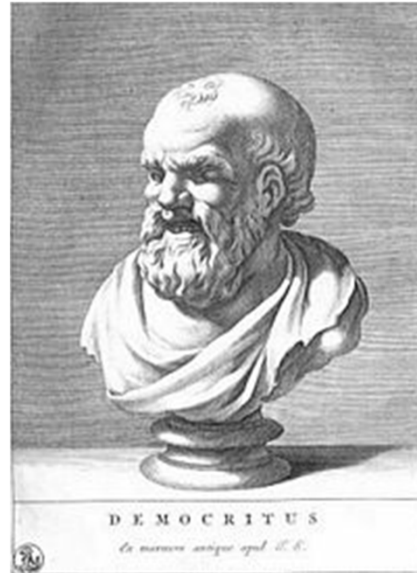
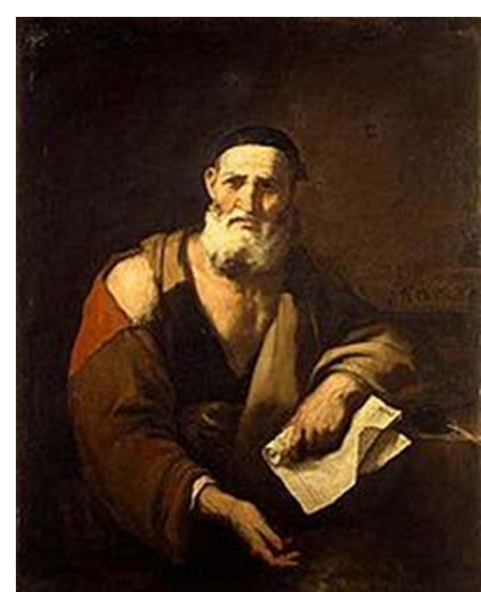

Leucippis and Democritus held a deterministic view, but Epicurus and Lucretius considered "swerving of the atoms", i.e., that Nature has a fundamentally random character.

However, even as late as 1900 people such as Mach doubted that atoms exist, perhaps because "seeing is believing", and atoms are too small to be "seen" with visible light.

⇒ Need better microscopes!

[And need better vacuum, so individual atoms have a long mean free path.]

In memoriam: UT philosopher and "amateur" antenna physicist, L.B. Cebik (1939-2008).



# Subatomic Particles

The era of particle physics began in 1897 with the "discovery" of the electron by JJ Thomson. This effort followed many other studies of "rays" in partially evacuated tubes.

Thomson had the better vacuum pump, but poor enough that the glow of gas atoms struck by electrons circling in a magnetic field could still be "seen".

The discovery that the nucleus of the atom is very small is due to Geiger, Marsden and Rutherford (1909).

They used a "microscope" in which  $\alpha$ -particles (helium nuclei), rather than light, reflected off a heavy nucleus, which latter was thereby "seen."

Heisenberg (1927) transforms the resolving power of a microscope,  $\theta = \lambda / d$ , into the "uncertainty principle:  $\Delta x = \hbar / \Delta p$ ,  
 $\Rightarrow$  Need high energy/momentum to "see" small objects.



# A Century of Elementary Particle Physics

## Standard Model of FUNDAMENTAL PARTICLES AND INTERACTIONS

The Standard Model is a quantum theory that summarizes our current knowledge of the physics of fundamental particles and fundamental interactions (interactions are manifested by forces and by decay rates of unstable particles).

### FERMIONS

matter constituents  
spin = 1/2, 3/2, 5/2, ...

Leptons spin = 1/2		
Flavor	Mass GeV/c <sup>2</sup>	Electric charge
$\nu_e$ lightest neutrino*	$(0-0.13)\times 10^{-9}$	0
e electron	0.000511	-1
$\nu_\mu$ middle neutrino*	$(0.009-0.13)\times 10^{-9}$	0
$\mu$ muon	0.106	-1
$\nu_\tau$ heaviest neutrino*	$(0.04-0.14)\times 10^{-9}$	0
$\tau$ tau	1.777	-1

Quarks spin = 1/2		
Flavor	Approx. Mass GeV/c <sup>2</sup>	Electric charge
u up	0.002	2/3
d down	0.005	-1/3
c charm	1.3	2/3
s strange	0.1	-1/3
t top	173	2/3
b bottom	4.2	-1/3

\*See the neutrino paragraph below.

Spin is the intrinsic angular momentum of particles. Spin is given in units of  $\hbar$ , which is the quantum unit of angular momentum where  $\hbar = h/2\pi = 6.58 \times 10^{-25}$  GeV s =  $1.05 \times 10^{-34}$  J s.

Electric charges are given in units of the proton's charge. In SI units the electric charge of the proton is  $1.60 \times 10^{-19}$  coulombs.

The energy unit of particle physics is the electronvolt (eV), the energy gained by one electron in crossing a potential difference of one volt. Masses are given in GeV/c<sup>2</sup> (remember  $E = mc^2$ ) where  $1 \text{ GeV} = 10^9 \text{ eV} = 1.60 \times 10^{-10}$  joule. The mass of the proton is  $0.938 \text{ GeV}/c^2 = 1.67 \times 10^{-27}$  kg.

### Neutrinos

Neutrinos are produced in the sun, supernovae, reactors, accelerator collisions, and many other processes. Any produced neutrino can be described as one of three neutrino flavor states  $\nu_e$ ,  $\nu_\mu$ , or  $\nu_\tau$ , labelled by the type of charged lepton associated with its production. Each is a defined quantum mixture of the three definite mass neutrinos  $\nu_1$ ,  $\nu_2$ , and  $\nu_3$  for which currently allowed mass ranges are shown in the table. Further exploration of the properties of neutrinos may yield powerful clues to puzzles about matter and antimatter and the evolution of stars and galaxy structures.

### Matter and Antimatter

For every particle type there is a corresponding antiparticle type, denoted by a bar over the particle symbol (unless + or - charge is shown). Particle and antiparticle have identical mass and spin but opposite charges. Some electrically neutral bosons (e.g.,  $Z^0$ ,  $\gamma$ , and  $\eta_c = c\bar{c}$  but not  $K^0 = d\bar{s}$ ) are their own antiparticles.

### Particle Processes

These diagrams are an artist's conception. Blue-green shaded areas represent the cloud of gluons.

A free neutron (udd) decays to a proton (uud), an electron, and an antineutrino via a virtual (mediating) W boson. This is neutron  $\beta$  (beta) decay.

An electron and positron (antilepton) colliding at high energy can annihilate to produce  $B^0$  and  $B^0$  mesons via a virtual Z boson or a virtual photon.

### Standard Model of

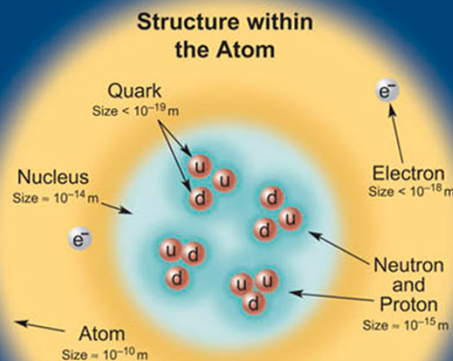

If the proton and neutrons in this picture were 10 cm across, then the quarks and electrons would be less than 0.1 mm in size and the entire atom would be about 10 km across.

### Properties of the Interactions

The strengths of the interactions (forces) are shown relative to the strength of the electromagnetic force for two u quarks separated by the specified distances.

Property	Gravitational Interaction	Weak Interaction (Electroweak)	Electromagnetic Interaction	Strong Interaction
Acts on:	Mass - Energy	Flavor	Electric Charge	Color Charge
Particles experiencing:	All	Quarks, Leptons	Electrically Charged	Quarks, Gluons
Particles mediating:	Graviton (not yet observed)	$W^+$ $W^-$ $Z^0$	$\gamma$	Gluons
Strength at $\begin{cases} 10^{-18} \text{ m} \\ 3 \times 10^{-17} \text{ m} \end{cases}$	$10^{-41}$	0.8	1	25
	$10^{-41}$	$10^{-4}$	1	60

### Unsolved Mysteries

Driven by new puzzles in our understanding of the physical world, particle physicists are following paths to new wonders and startling discoveries. Experiments may even find extra dimensions of space, mini-black holes, and/or evidence of string theory.

#### Universe Accelerating?

The expansion of the universe appears to be accelerating. Is this due to Einstein's Cosmological Constant? If not, will experiments reveal a new force of nature or even extra (hidden) dimensions of space?

#### Why No Antimatter?

Matter and antimatter were created in the Big Bang. Why do we now see only matter except for the tiny amounts of antimatter that we make in the lab and observe in cosmic rays?

#### Dark Matter?

Invisible forms of matter make up much of the mass observed in galaxies and clusters of galaxies. Does this dark matter consist of new types of particles that interact very weakly with ordinary matter?

#### Origin of Mass?

In the Standard Model, for fundamental particles to have masses, there must exist a particle called the Higgs boson. Will it be discovered soon? Is supersymmetry theory correct in predicting more than one type of Higgs?

Unified Electroweak spin = 1		
Name	Mass GeV/c <sup>2</sup>	Electric charge
$\gamma$ photon	0	0
$W^-$	80.39	-1
$W^+$	80.39	+1
$Z^0$ Z boson	91.188	0

### BOSONS

force carriers  
spin = 0, 1, 2, ...

Strong (color) spin = 1		
Name	Mass GeV/c <sup>2</sup>	Electric charge
g gluon	0	0

### Color Charge

Only quarks and gluons carry "strong charge" (also called "color charge") and can have strong interactions. Each quark carries three types of color charge. These charges have nothing to do with the colors of visible light. Just as electrically charged particles interact by exchanging photons, in strong interactions, color-charged particles interact by exchanging gluons.

### Quarks Confined in Mesons and Baryons

Quarks and gluons cannot be isolated - they are confined in color-neutral particles called hadrons. This confinement (binding) results from multiple exchanges of gluons among the color-charged constituents. As color-charged particles (quarks and gluons) move apart, the energy in the color-force field between them increases. This energy eventually is converted into additional quark-antiquark pairs. The quarks and antiquarks then combine into hadrons; these are the particles seen to emerge.

Two types of hadrons have been observed in nature mesons  $q\bar{q}$  and baryons  $qqq$ . Among the many types of baryons observed are the proton (uud), antiproton ( $\bar{u}\bar{u}\bar{d}$ ), neutron (udd), lambda  $\Lambda$  (uds), and omega  $\Omega^-$  (sss). Quark charges add in such a way as to make the proton have charge 1 and the neutron charge 0. Among the many types of mesons are the pion  $\pi^+$  ( $u\bar{d}$ ), kaon  $K^-$  ( $s\bar{u}$ ),  $B^0$  ( $d\bar{s}$ ), and  $\eta_c$  ( $c\bar{c}$ ). Their charges are +1, -1, 0, 0 respectively.

Visit the award-winning web feature [The Particle Adventure at ParticleAdventure.org](http://TheParticleAdventure.org)

This chart has been made possible by the generous support of:  
U.S. Department of Energy  
U.S. National Science Foundation  
Lawrence Berkeley National Laboratory

©2006 Contemporary Physics Education Project. CPEP is a non-profit organization of teachers, physicists, and educators. For more information see

[CPEPweb.org](http://CPEPweb.org)

# The Astrophysical Picture (WMAP)

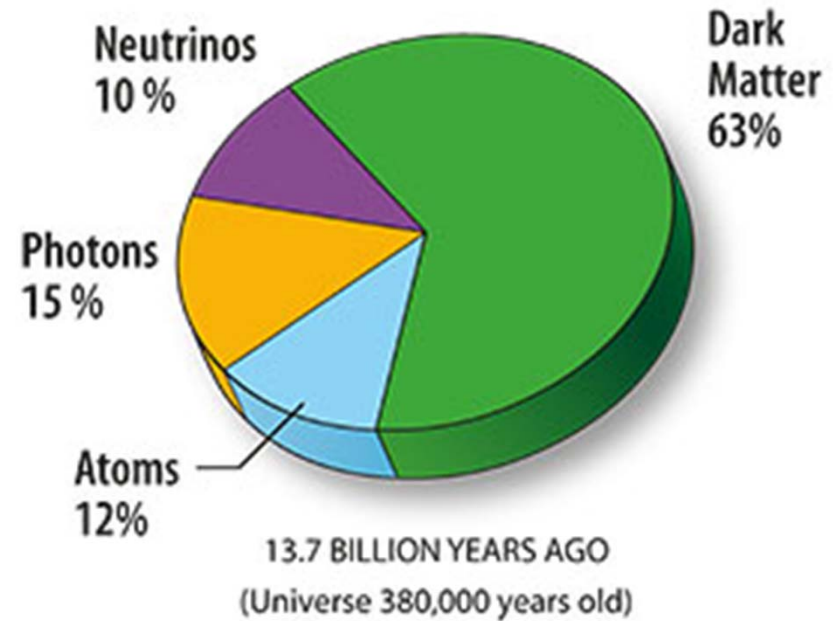
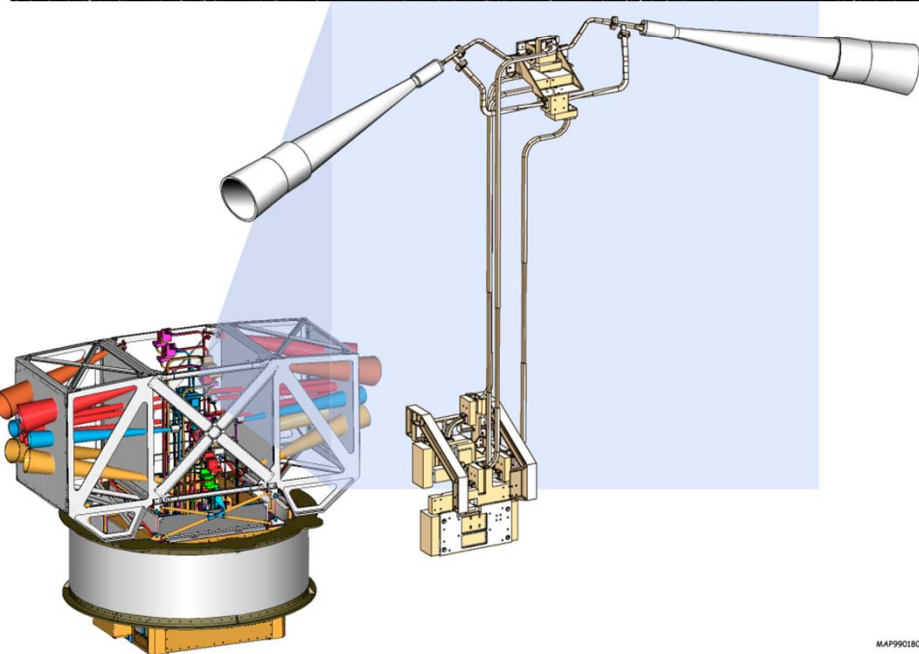
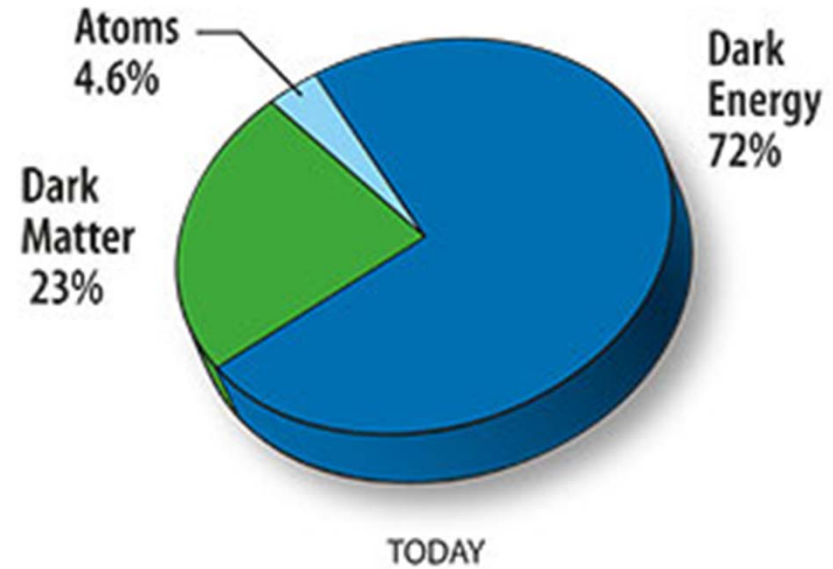
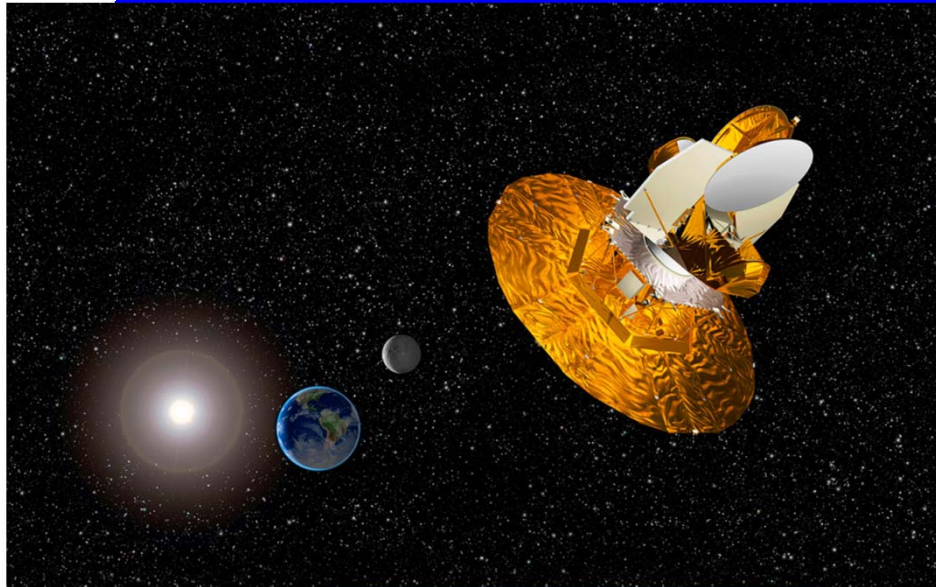

# Questions for Future Particle Physics Experiments

## Unsolved Mysteries

Driven by new puzzles in our understanding of the physical world, particle physicists are following paths to new wonders and startling discoveries. Experiments may even find extra dimensions of space, mini-black holes, and/or evidence of string theory.

### Universe Accelerating?



The expansion of the universe appears to be accelerating. Is this due to Einstein's Cosmological Constant? If not, will experiments reveal a new force of nature or even extra (hidden) dimensions of space?

### Why No Antimatter?



Matter and antimatter were created in the Big Bang. Why do we now see only matter except for the tiny amounts of antimatter that we make in the lab and observe in cosmic rays?

### Dark Matter?



Invisible forms of matter make up much of the mass observed in galaxies and clusters of galaxies. Does this dark matter consist of new types of particles that interact very weakly with ordinary matter?

### Origin of Mass?



In the Standard Model, for fundamental particles to have masses, there must exist a particle called the Higgs boson. Will it be discovered soon? Is supersymmetry theory correct in predicting more than one type of Higgs?

Of these 4 questions, 3 can be addressed by experiments with particle-beam "microscopes".

Why no antimatter?

Dark Matter?

Origin of Mass?

Clues from neutrino mixing.

Search for production of new particles

Search for evidence of the Higgs particle/field



# Are Particles Really Quasiparticles?

Quasiparticles are "particles" whose mass is affected/determined by their interaction with a "background field."

An early concept of a quasiparticle is a charged particle in a strong electromagnetic wave (Volkow, 1937), where  $m_{\text{eff}} = m\sqrt{1+\eta^2}$ , with  $\eta = eE / m\omega c$ .

In the Standard Model, a scalar background field is thought to affect (determine?) the masses of the "elementary" particles (Higgs, 1964).

⇒ Search for the Higgs boson.

SLAC E-144 was an experiment with electrons and a laser beam for which  $\eta \approx 0.3$ , such that a 10% electron mass shift occurred (and  $e^+e^-$  pairs were produced in light-by-light collisions.)

[Photon "solid:"  
The number density of photons at the laser focus was 10 times the electron density in lead.]

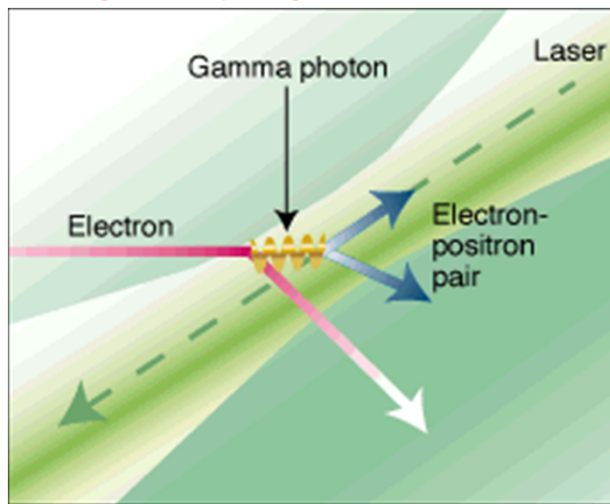

Phys. Rev. D **60**, 092004 (1999)



# "Microscopes" for Future Particle Physics

---

Since the time of Rutherford, "microscopes" for study of elementary particles do not use light/photons, but rather charged particles (electrons or protons) to illuminate/probe small objects.

**Electron** beams probe the electromagnetic structure of matter.

**Proton** (and **neutron**) beams probe the strong (quark/gluon) structure of matter.

Since ~ 1970, **neutrino** beams have also been used to probe the weak (hypercharge) structure of matter.

Since quarks are electrically charged, and have weak hypercharge as well, all 3 types of beams probe aspects of all known "matter."

Protons are composed of quarks and gluons, so proton beams are in effect quark/gluon beams, in which the energy/momentum of the quarks and gluons has a broad spectrum.

⇒ Protons beams good for providing a "broad-brush" picture of elementary particles, whereas leptons beams (electrons and neutrinos) can provide finer detail.

The present major effort with high-energy particle beams is at the CERN Large Hadron Collider (LHC), which uses proton beams.





# High-Energy Collisions Create Particles

An aspect of Nature not captured by the "microscope" analogy to its study is  $E = m c^2$ .

If the energy of a beam particle is a few times larger than its mass (or the mass of the target/illuminated particle), then the interaction of beam and target includes the creation of new particles.

This complication has become a central feature of "high-energy microscopes", as it greatly expands the types of matter that can be studied.

If the goal is to produce new particles, it is advantageous that the center of mass energy of the beam and target particles be as large as possible.

⇒ Best to have both beam and target particles in motion, such that they collide head-on.

## High-Energy Microscopes Are Beam-Beam Colliders

Hence the Large Hadron Collider is a proton-proton collider (with options for heavy-ion collisions).



# A New Type of Collider: $\mu^+\mu^-$

As far as we know, electrons (and positrons) are not composite particles, so an  $e^+e^-$  collider provides a well-defined initial state in which all energy is concentrated in two fundamental particles.

However, electrons have relatively low mass,  $m_e$ , so the electric field  $E$  of one beam can lead to substantial acceleration of electrons in the other beam.

⇒ Initial state radiation, with power  $P \sim a^2 \sim E^2 / m_e^2$ , which smears the energy of eventual  $e^+e^-$  collisions.

This effect is much stronger at high energy, because the electric field  $E$  of fast-moving charges is “flattened into a pancake” ⇒ much larger  $E$ .

Solution: Use a beam particle that is not composite, but has higher mass than electron.

## Enter the Muon ( $\mu^\pm$ )

$m_\mu / m_e \sim 207$ , but otherwise their properties are very similar.

I.I. Rabi: “Who ordered that?”

One answer: Designers of better high-energy microscopes.



# Physics Advantages of a $\mu^+\mu^-$ Collider

Narrower center-of-mass energy spread at high energies ( $\Rightarrow$  precision studies of partners  $Z'$  to the  $Z^0$  vector boson, if these exist)

Since the coupling of the Higgs boson to particles is proportional to their mass, will have good rate for the process  $\mu^+\mu^- \rightarrow h$ , if the Higgs particle  $h$  actually exists (**Higgs Factory**).

Muons decay to neutrinos, so the technology of a  $\mu^+\mu^-$  collider also leads to a so-called **Neutrino Factory**.

(V. Shiltsev, 6/9/09)

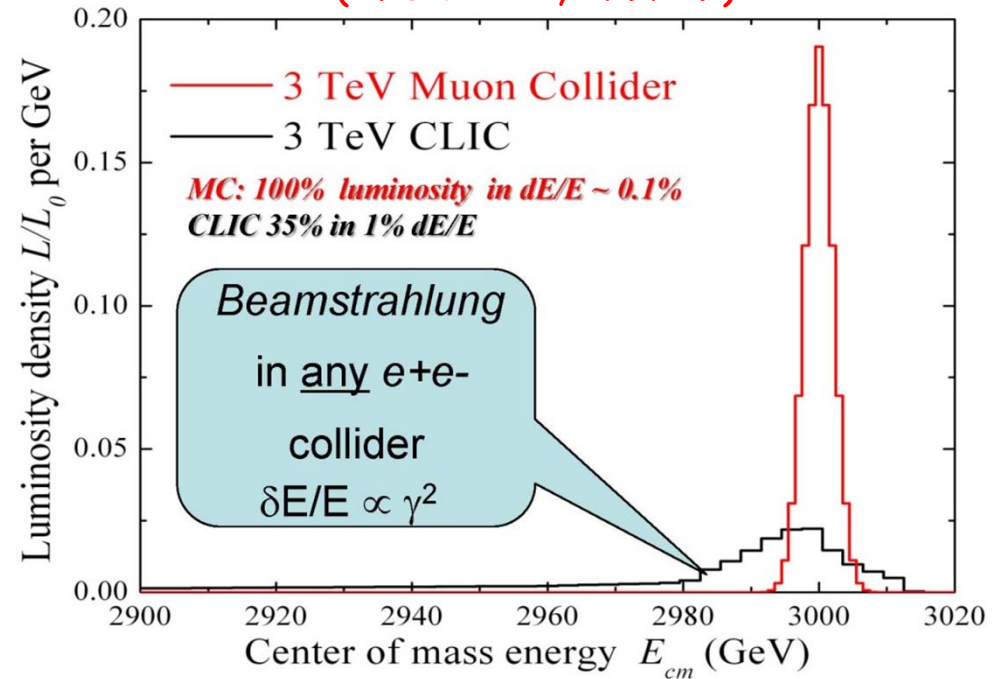

LHC  
PP  
(1.5 TeV)

ILC  $e^+e^-$  (.5 TeV)

CLIC  $e^+e^-$  (3TeV)

FNAL site Mu-Mu (4 TeV)

10 km

(R.B. Palmer, 6/27/11)

## Technical Advantage

A muon collider can circular, and much smaller than  $pp$  or  $e^+e^-$  colliders of comparable center of mass energies.



# Sketch of a Muon Collider (and a Neutrino Factory)

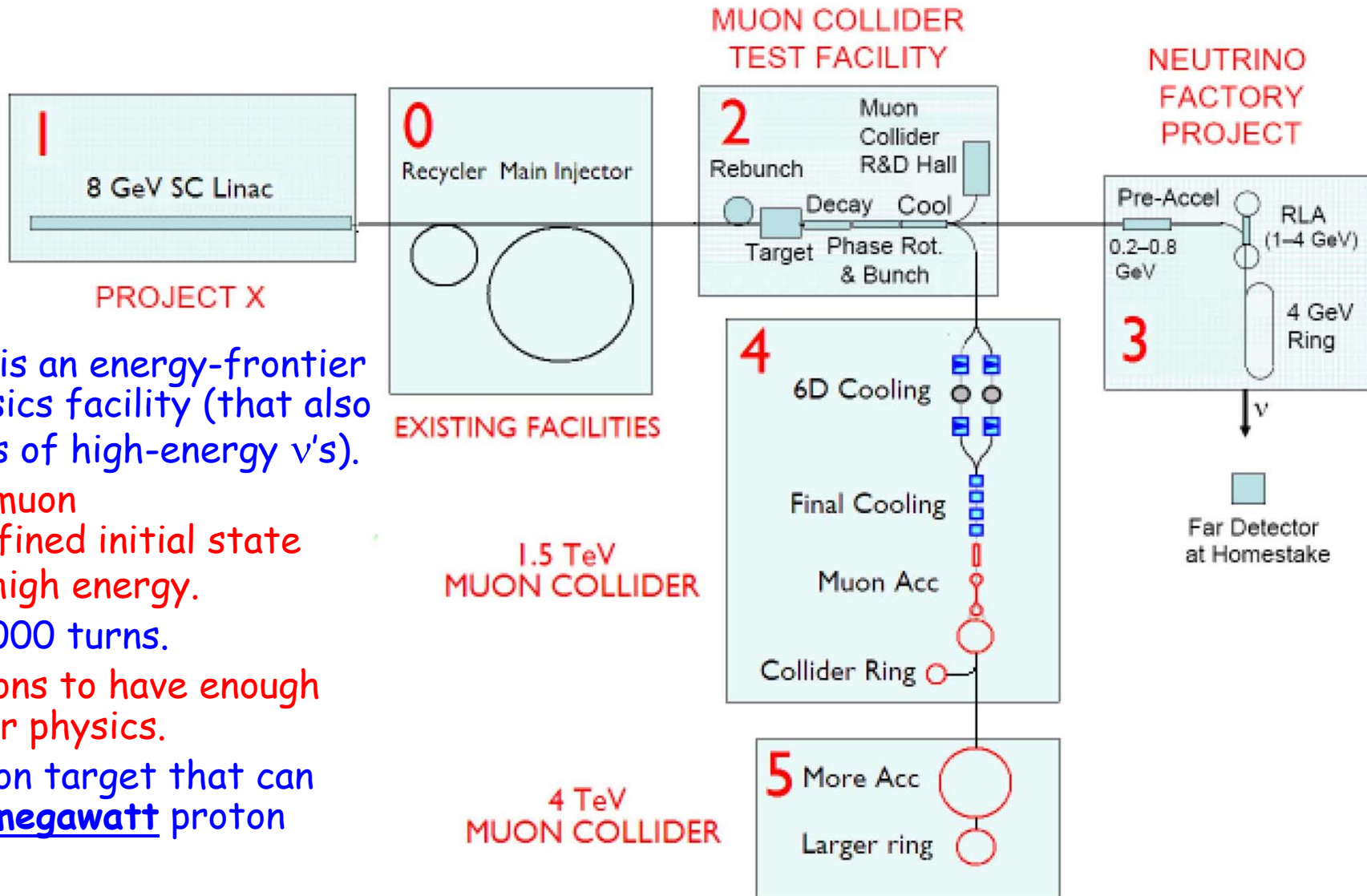

A Muon Collider is an energy-frontier particle-physics facility (that also produces lots of high-energy  $\nu$ 's).

Higher mass of muon  
 $\Rightarrow$  Better defined initial state than  $e^+e^-$  at high energy.

A muon lives  $\approx 1000$  turns.

Need lots of muons to have enough luminosity for physics.

Need a production target that can survive multimegawatt proton beams.



# START WITH PROJECT X at Fermilab

Neutrinos  
Muons  
Kaons  
Nuclei

“simultaneously”

(S. Geer, 6/30/11)

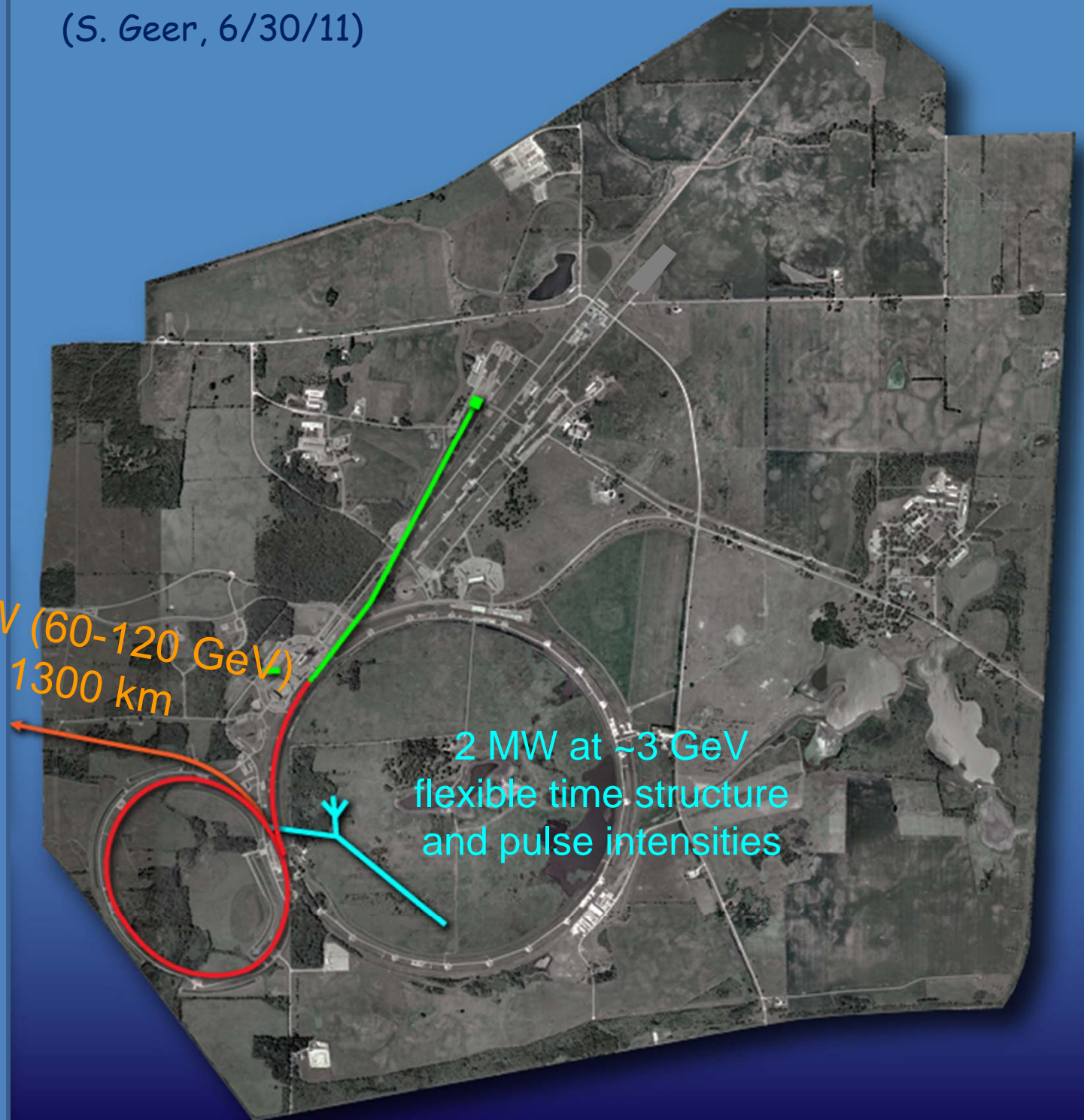

# ADD NEUTRINO FACTORY

Enhanced Neutrinos  
Enhanced Muons  
Muon Collider test bed  
Kaons  
Nuclei

“simultaneously”

4MW protons  
5 GeV muons  
1300 km

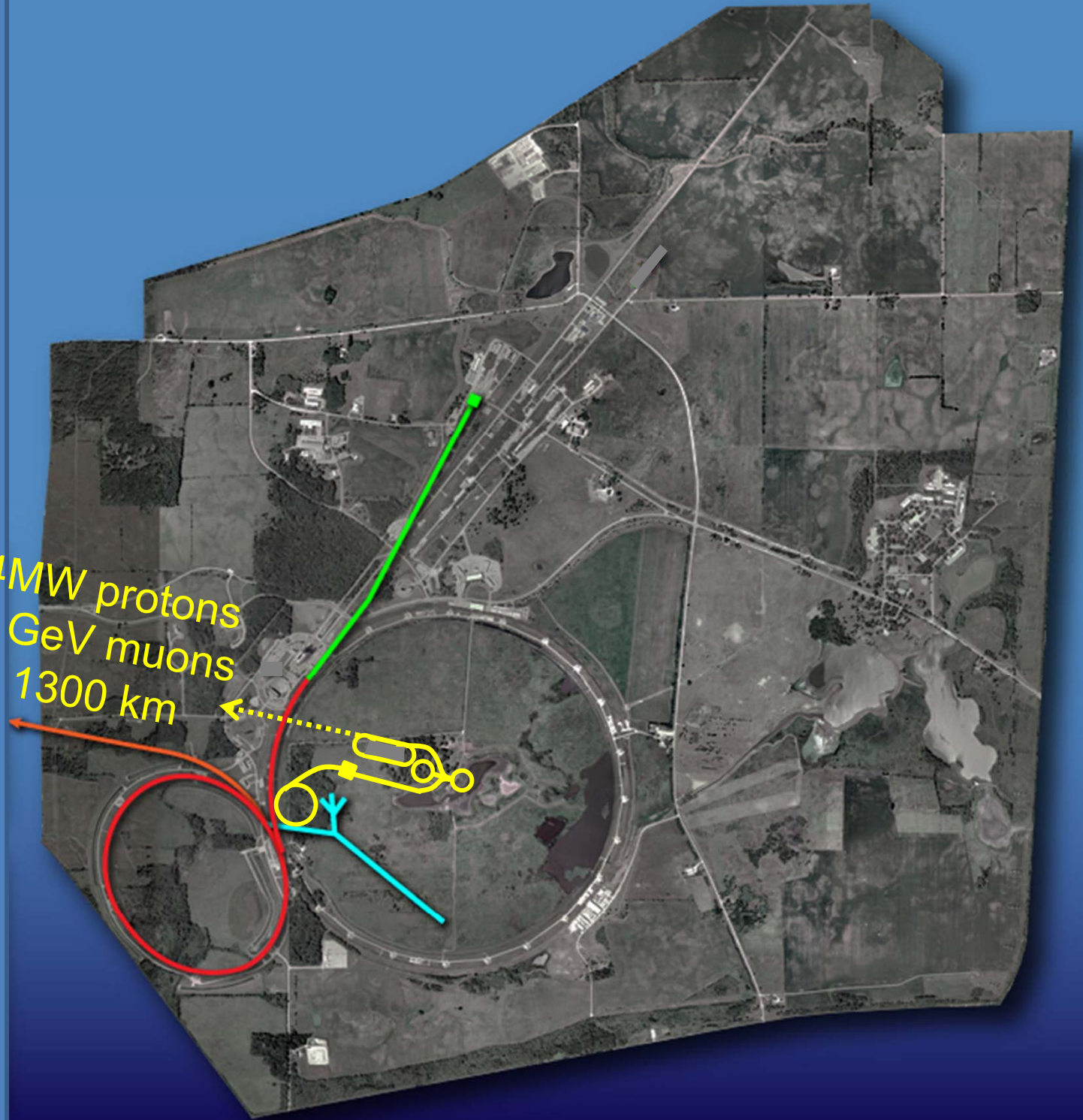

ADD  
MUON  
COLLIDER

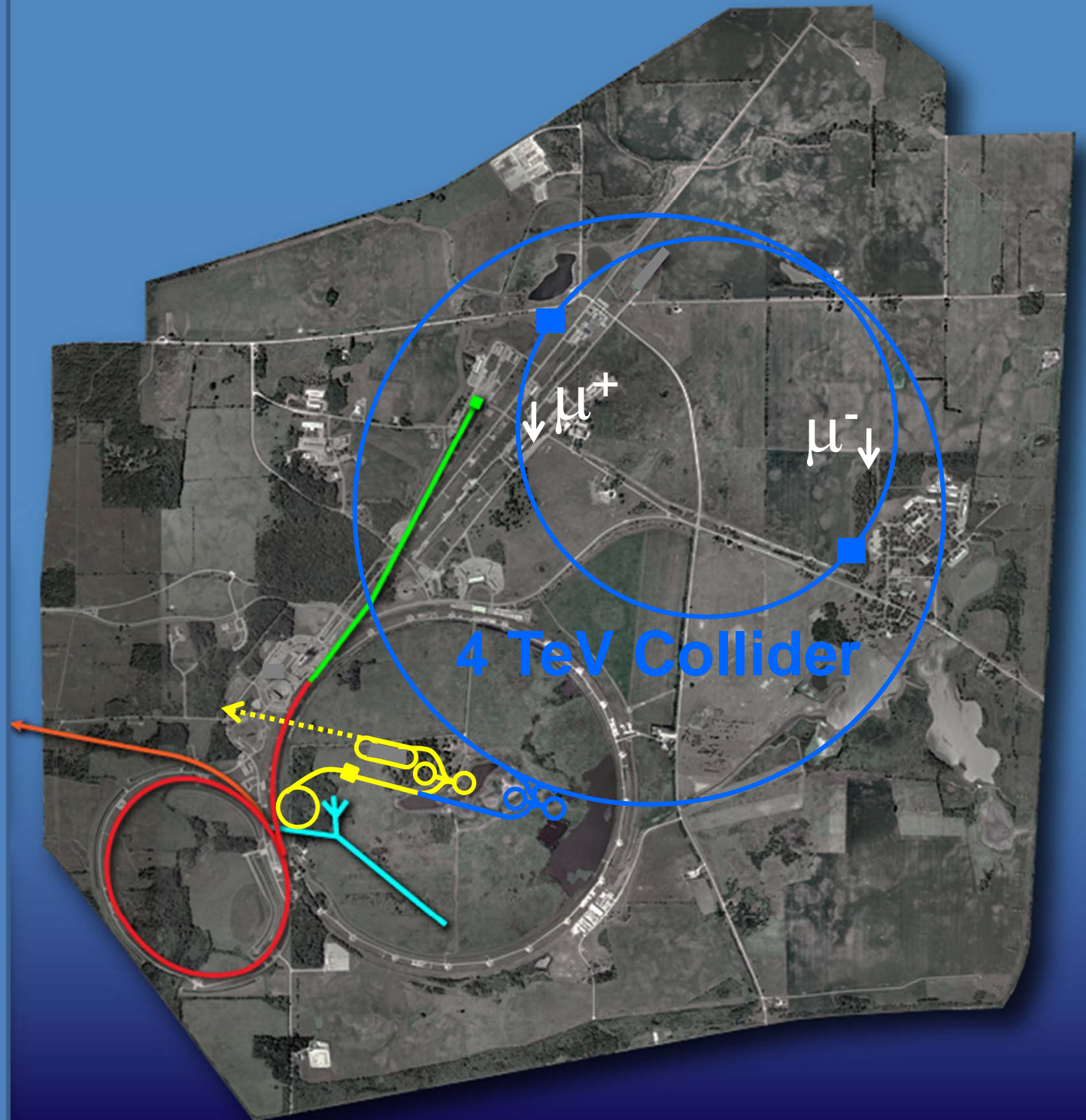

But, is it as easy as 1-2-3?

- Muons created as tertiary beam ( $p \rightarrow \pi \rightarrow \mu$ )
  - low production rate
    - need target that can tolerate multi-MW beam
  - large energy spread and transverse phase space
    - need emittance cooling
    - high-acceptance acceleration system and decay ring
- Muons have short lifetime ( $2.2 \mu\text{s}$  at rest)
  - puts premium on rapid beam manipulations
    - high-gradient radio-frequency (RF) cavities (in magnetic field for cooling)
    - presently untested ionization cooling technique
    - fast acceleration system



- Ionization cooling analogous to familiar synchrotron radiation (SR) damping process in electron storage rings
  - energy loss (SR or  $dE/dx$ ) reduces  $p_x, p_y, p_z$
  - energy gain (RF cavities) restores only  $p_z$
  - repeating this reduces  $p_{x,y}/p_z$

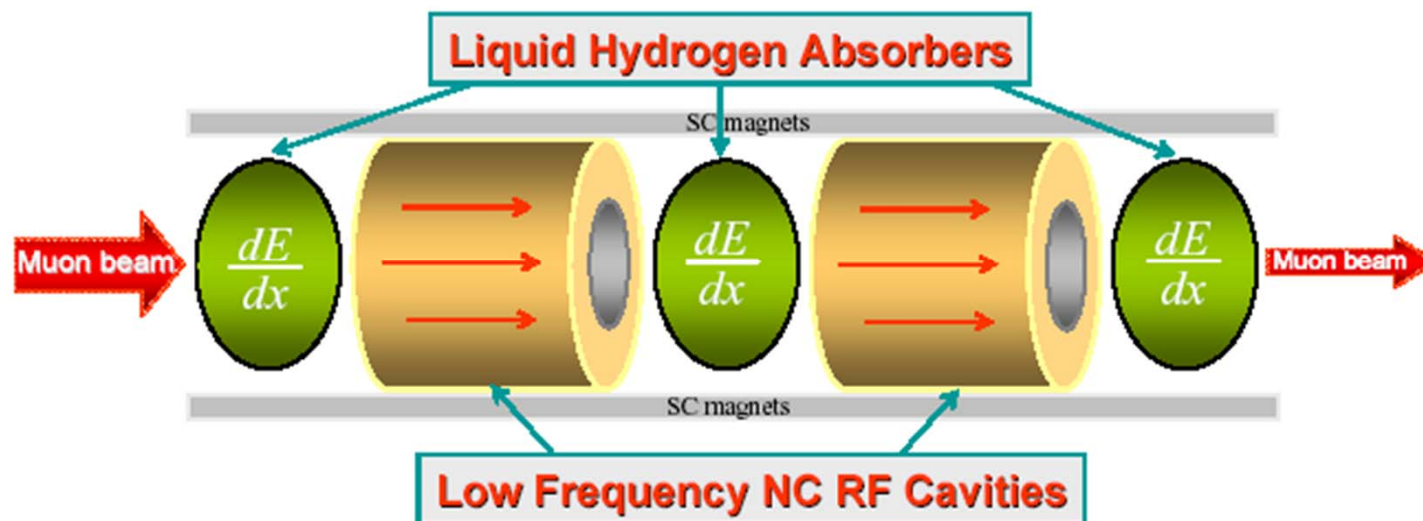

- There is also a heating term
  - for synchrotron radiation (in electron rings) it is quantum excitation [aka Hawking/Unruh thermal bath seen by accelerated observers (J.S. Bell, 1982)]
  - for ionization cooling it is multiple scattering

- Balance between heating and cooling gives equilibrium emittance

$$\frac{d\varepsilon_N}{ds} = - \frac{1}{\beta^2} \left| \frac{dE_\mu}{ds} \right| \frac{\varepsilon_N}{E_\mu} + \frac{\beta_\perp (0.014 \text{ GeV})^2}{2 \beta^3 E_\mu m_\mu X_0}$$

Cooling

Heating

$$\varepsilon_{x,N,equil.} = \frac{\beta_\perp (0.014 \text{ GeV})^2}{2 \beta m_\mu X_0 \left| \frac{dE_\mu}{ds} \right|}$$

- prefer low  $\beta_\perp$  (strong focusing), large  $X_0$  and  $dE/ds$  ( $H_2$  is best)

## Proton beam parameters

- desired proton intensity for Neutrino Factory is 4 MW
  - *e.g.*,  $3.1 \times 10^{15}$  p/s at 8 GeV or  $6.2 \times 10^{13}$  p/pulse at 50 Hz
- desired rms bunch length is 1-3 ns to minimize intensity loss
  - not easily done at high intensity and moderate energy

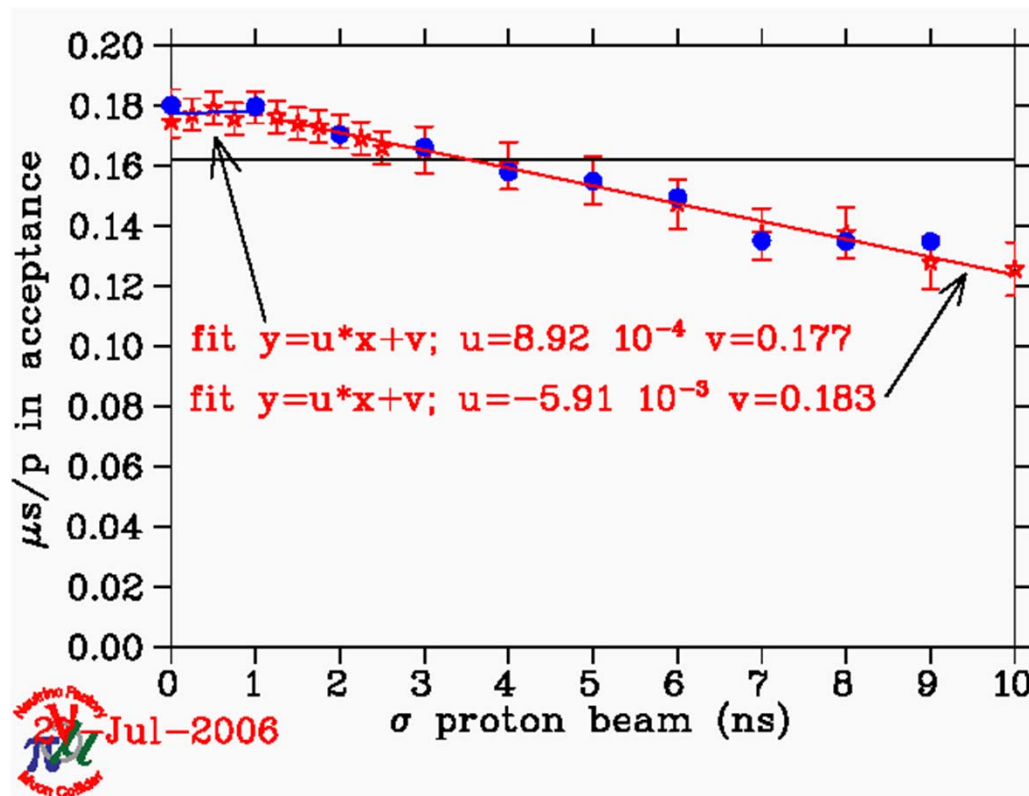

Difficult requirement at low beam energy (5-10 GeV)

## • Target

- favored target concept based on Hg jet in 20-T solenoid
  - jet velocity of  $\sim 20$  m/s establishes “new” target each beam pulse
    - magnet shielding is daunting, but appears manageable
- alternative approaches (powder or solid targets) also being pursued within EUROnu

### Hg-jet target (MERIT)

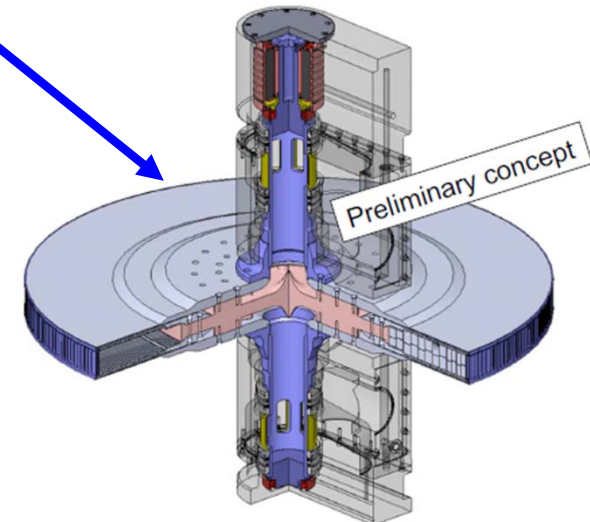
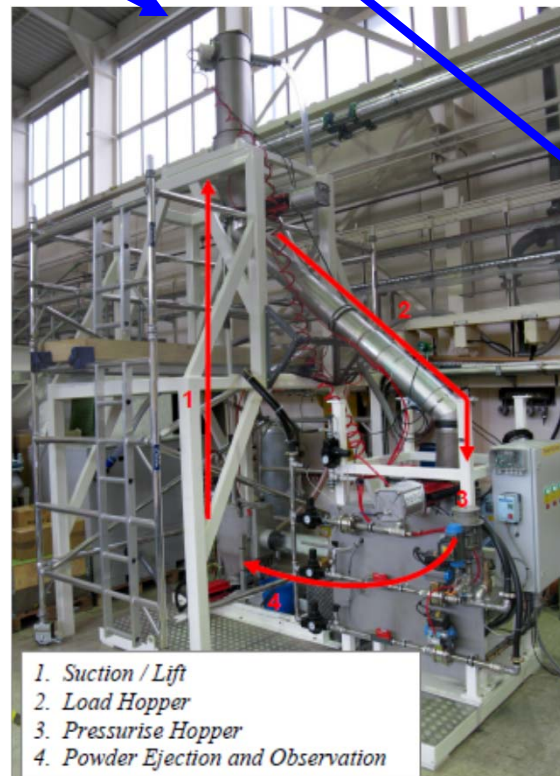
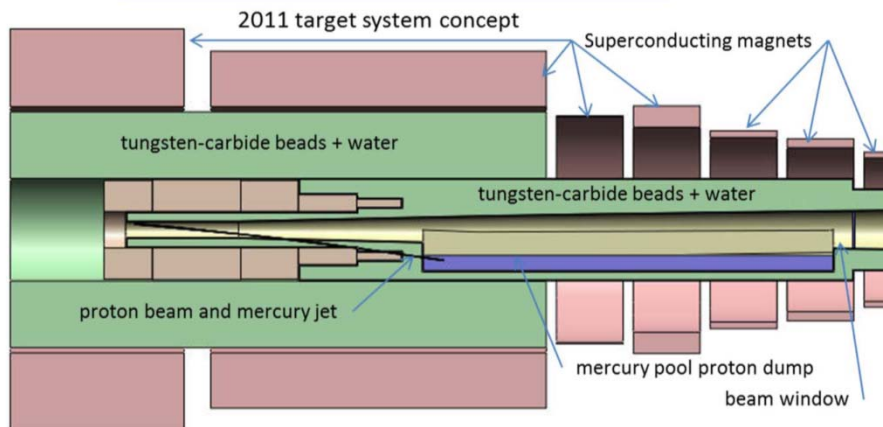

- Normal conducting RF in magnetic field
  - cooling channel requires this
    - 805-MHz experiments indicate substantial degradation of gradient in such conditions
      - initial 201-MHz tests show similar behavior
    - gas-filled cavities avoid performance degradation in magnetic field
      - effects of intense ionizing radiation traversing gas now under study
        - first indications are that beam loading is severe

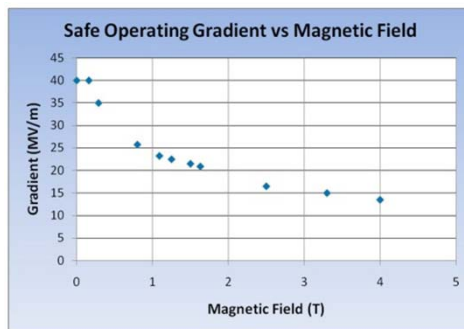
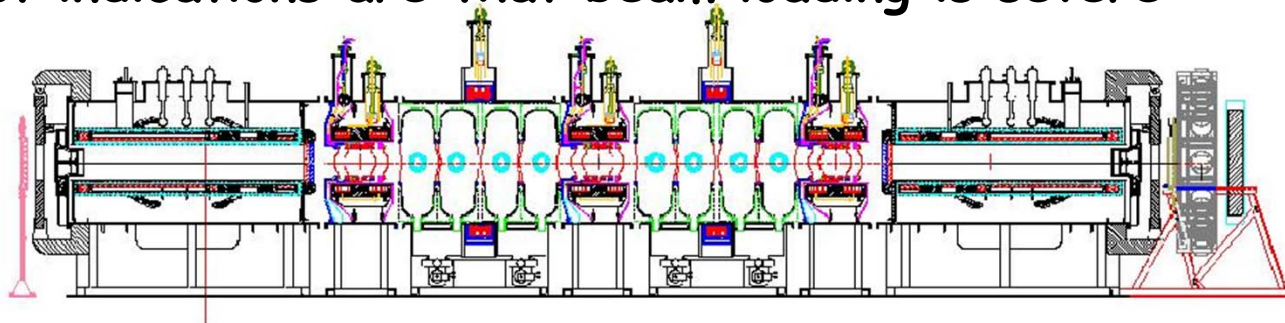

N<sub>2</sub> 500 psi

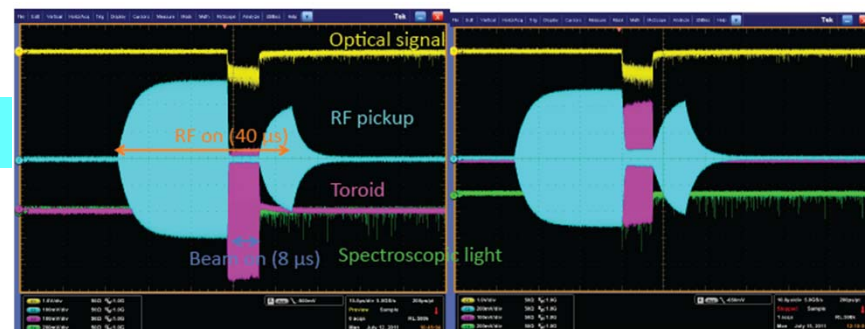

H<sub>2</sub> 900 psi



# Challenges ↔ Opportunities

---



↑  
R&D

In the USA, an R&D consortium has existed since 1997 [first called the Muon Collider (and Neutrino Factory) Collaboration] and now called the Muon Accelerator Program.

<http://map.fnal.gov/>

The Neutrino Factory is pursued in a worldwide context via the International Design Study for a Neutrino Factory.

<https://www.ids-nf.org/wiki/FrontPage>

# Example: Challenges in the Target System

- 5-50 GeV beam energy appropriate for Superbeams, Neutrino Factories and Muon Colliders.  
0.8-2.5  $\times 10^{15}$  pps; 0.8-2.5  $\times 10^{22}$  protons per year of  $10^7$  s.
  - MW energy dissipation requires liquid coolant somewhere in system!  

⇒ No such thing as "solid-target-only" at this power level.
  - Rep rate 15-50 Hz at Neutrino Factory/Muon Collider, as low as  $\approx 2$  Hz for Superbeam.  
⇒ Protons per pulse from  $1.6 \times 10^{13}$  to  $1.25 \times 10^{15}$ .  
⇒ Energy per pulse from 80 kJ to 2 MJ.
  - Small beam size preferred:  
 $\approx 0.1 \text{ cm}^2$  for Neutrino Factory/Muon Collider.
  - Pulse width: 

< 2 ns

 desired for Neutrino Factory/Muon Collider.
- ⇒ Severe materials issues for target AND beam dump.
- Radiation Damage.
  - Melting.
  - Cracking (due to single-pulse "thermal shock").



# Target and Capture Topology: Solenoid

Desire  $\approx 10^{14}$   $\mu/s$  from  $\approx 10^{15}$  p/s ( $\approx 4$  MW proton beam).

Highest rate  $\mu^+$  beam to date: PSI  $\mu E4$  with  $\approx 10^9$   $\mu/s$  from  $\approx 10^{16}$  p/s at 600 MeV.

$\Rightarrow$  Some R&D needed!

R. Palmer (BNL, 1994) proposed a solenoidal capture system.

Low-energy  $\pi$ 's collected from side of long, thin cylindrical target.

Collects both signs of  $\pi$ 's and  $\mu$ 's,

$\Rightarrow$  Shorter data runs (with magnetic detector).

Solenoid coils can be some distance from proton beam.

$\Rightarrow$   $\geq 4$ -year life against radiation damage at 4 MW.

Liquid mercury jet target replaced every pulse.

Proton beam readily tilted with respect to magnetic axis.

$\Rightarrow$  Beam dump (mercury pool) out of the way of secondary  $\pi$ 's and  $\mu$ 's.



## Present Target Concept

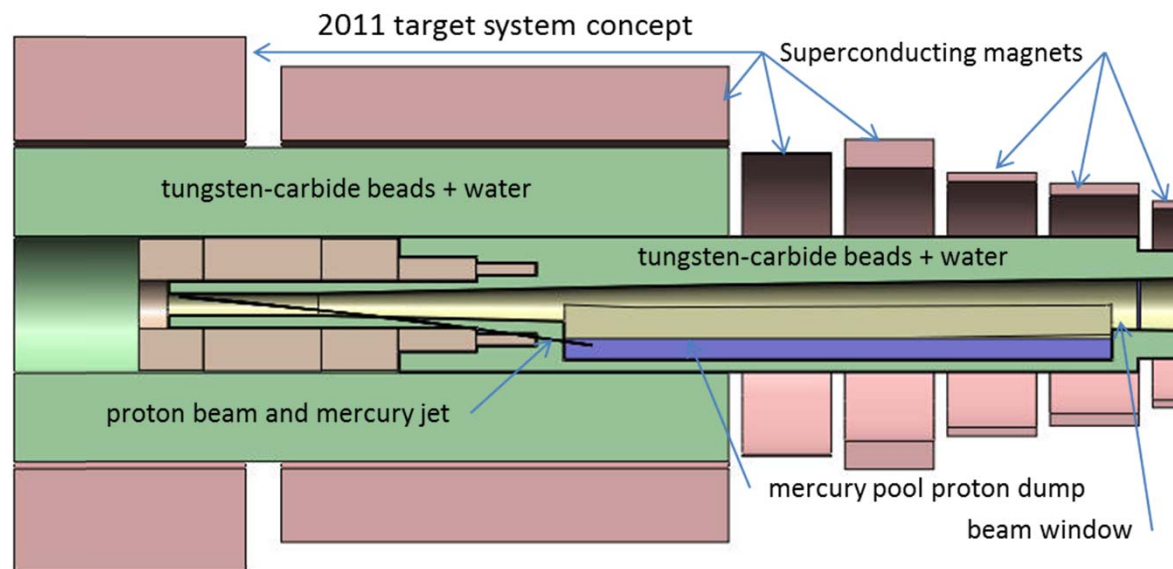

Shielding of the superconducting magnets from radiation is a major issue.

Magnet stored energy  $\sim 3$  GJ!

Use of "magnetic bottles" around production targets proposed by Djilkibaev and Lobashev, [http://puhep1.princeton.edu/~mcdonald/examples/detectors/djilkibaev\\_aipcp\\_372\\_53\\_95.pdf](http://puhep1.princeton.edu/~mcdonald/examples/detectors/djilkibaev_aipcp_372_53_95.pdf)





# Why 20 T?

---

The baseline scenario has pions produced (almost) on axis of a 20-T solenoid, followed by an “adiabatic” field tapered down to 1.5 T = field strength of front-end  $\pi/\mu$  beam transport.

We desire to capture all pions with  $p_{\perp} \leq 200 \text{ MeV}/c$ .

If used a 1.5-T solenoid around the target, would need aperture of radius 80 cm to capture these pions.

But, if use a 20-T solenoid these pions fit within an aperture of 7.5 cm.

The adiabatic taper down to 1.5 T has the adiabatic invariant  $\Phi_0 = \pi R_0^2 B_0 = \pi c^2 p_{0\perp}^2 / e^2 B_0$ , which implies that at the end of the taper the pions fit in an aperture of only 30 cm.

That is, the use of an initial strong solenoid provides a kind of “transverse cooling”.

In principle, this “cooling” would be even stronger if we could use a field higher than 20 T.



# CERN MERIT Experiment (Nov 2007)

Proof-of-principle demonstration of a mercury jet target in a strong magnetic field, with proton bunches of intensity equivalent to a 4-MW beam.

Performed in the TT2A/TT2 tunnels at CERN.

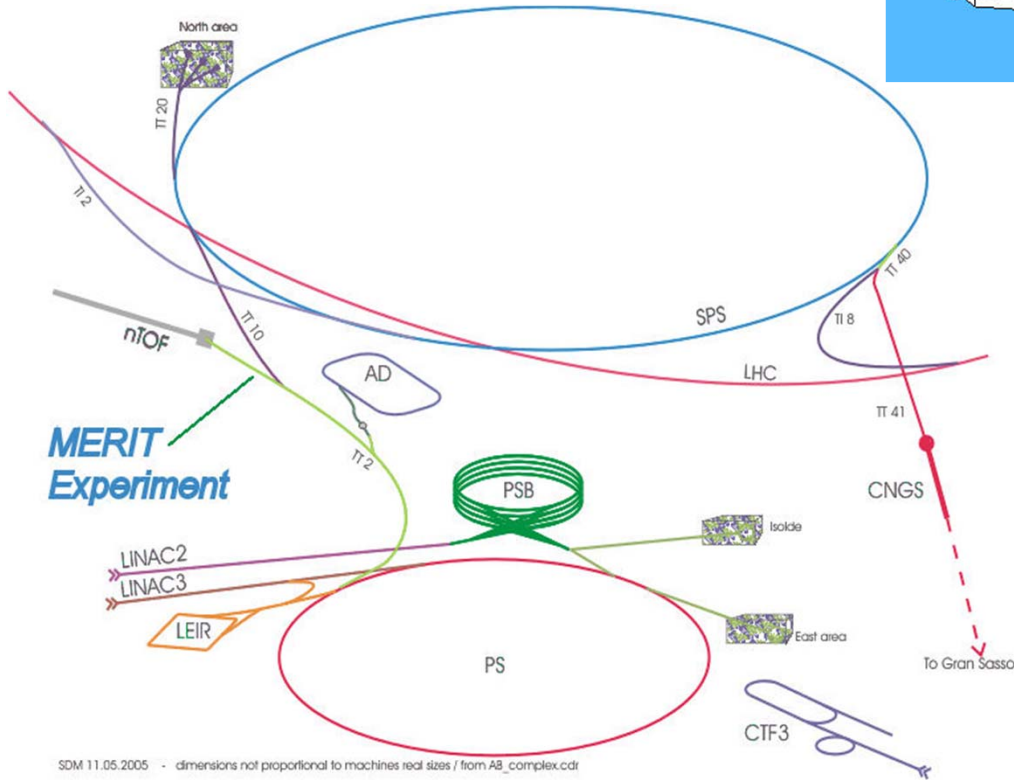
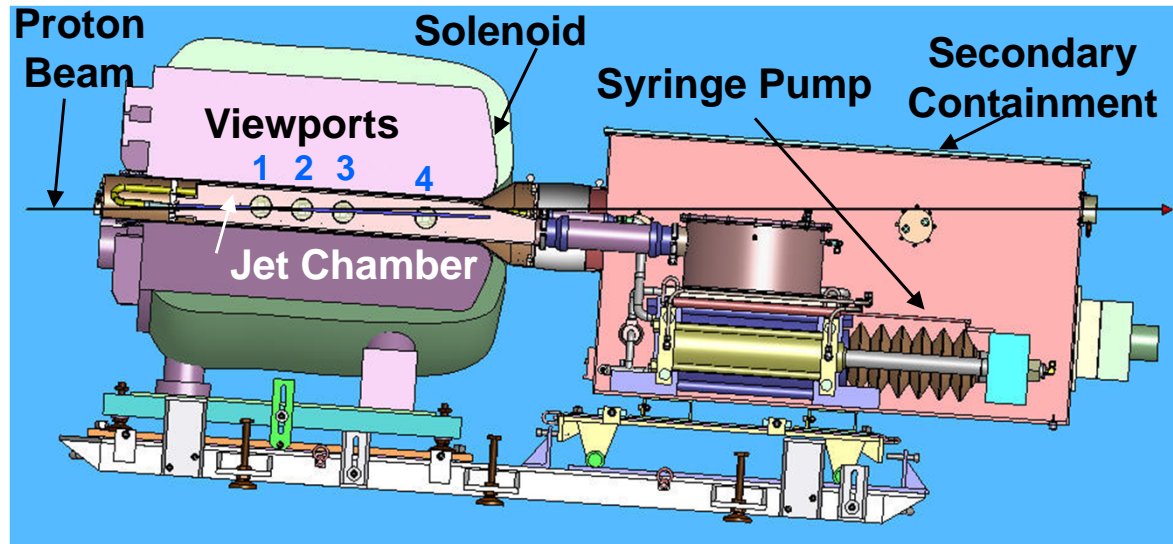

SDM 11.05.2005 - dimensions not proportional to machines real sizes / from AB\_complex.cdr



# MERIT Beam Pulse Summary

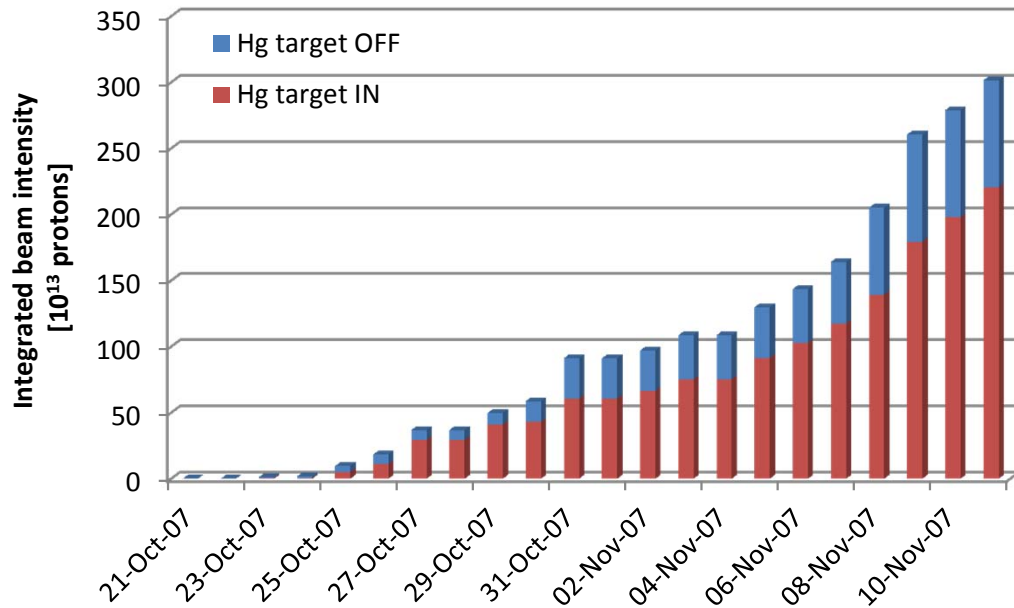

MERIT was not to exceed  $3 \times 10^{15}$  protons on Hg to limit activation.

**30 Tp shot @ 24 GeV/c**

- 115 kJ of beam power
- a PS machine record !

1 Tp =  $10^{12}$  protons

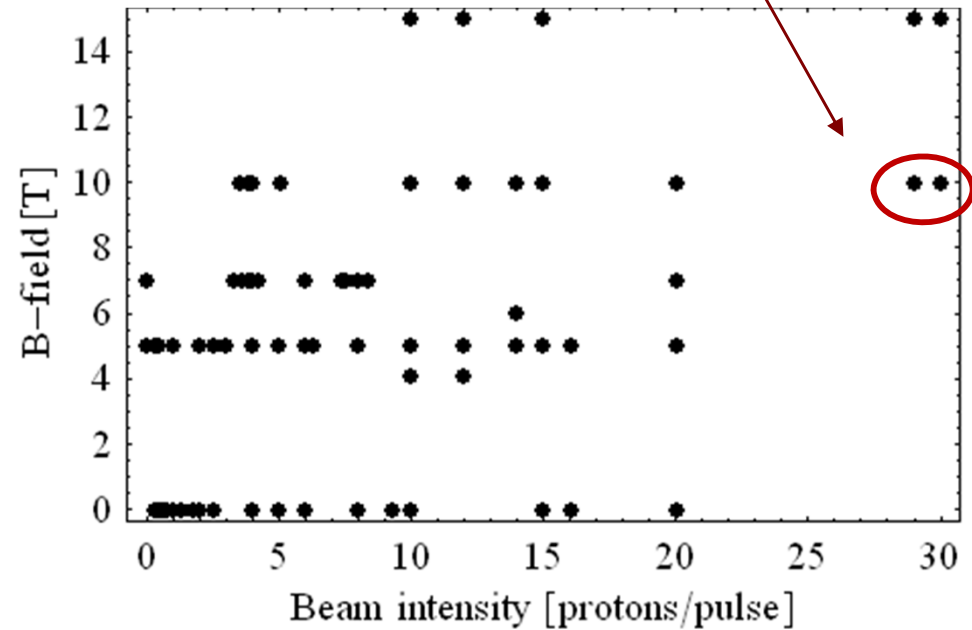

# Disruption Length Analysis (H. Park, PhD Thesis)

Observe jet at viewport 3 at 500 frames/sec,  
measure total length of disruption  
of the mercury jet by the proton beam.

Images for 10 T<sub>p</sub>, 24 GeV, 10 T:

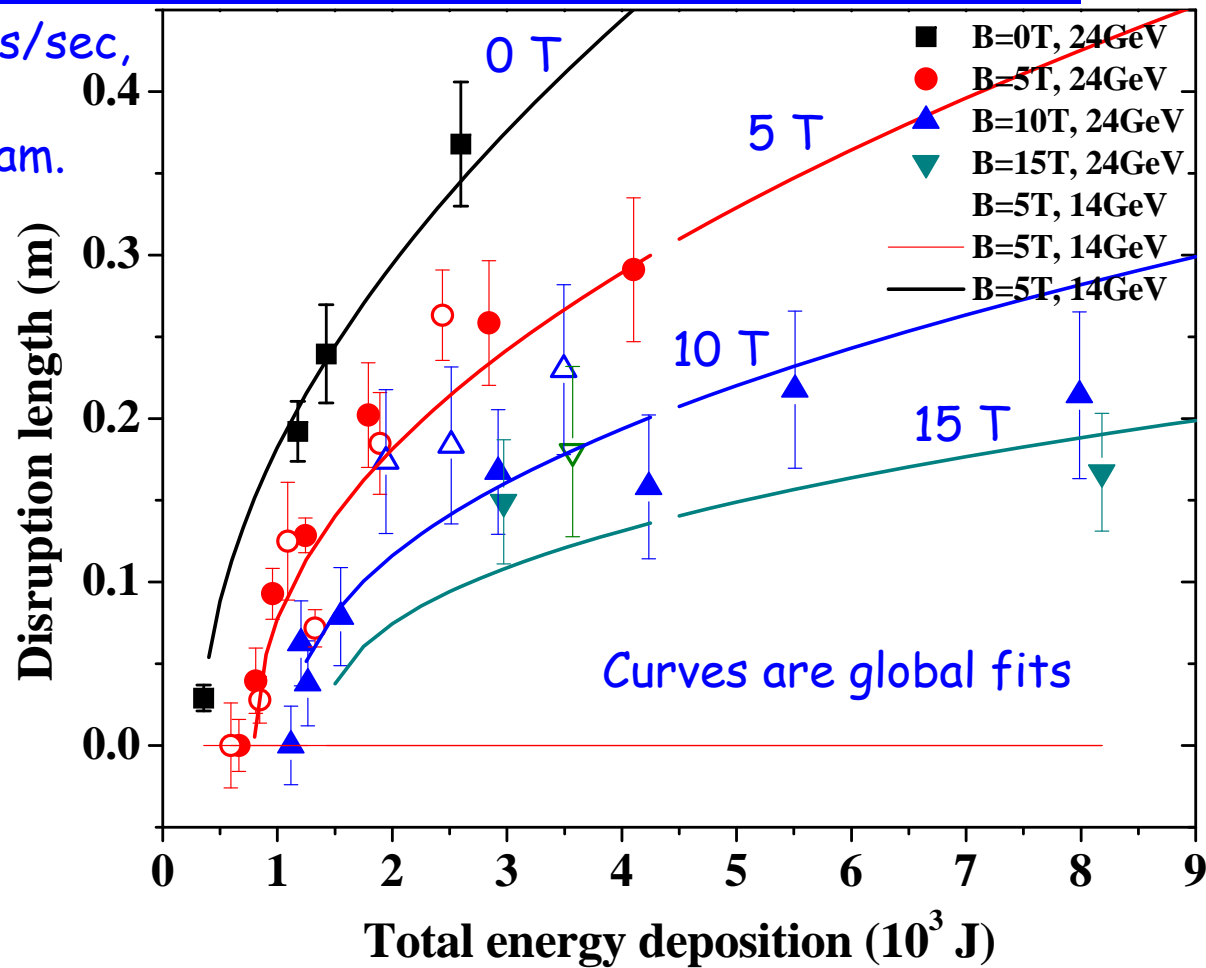
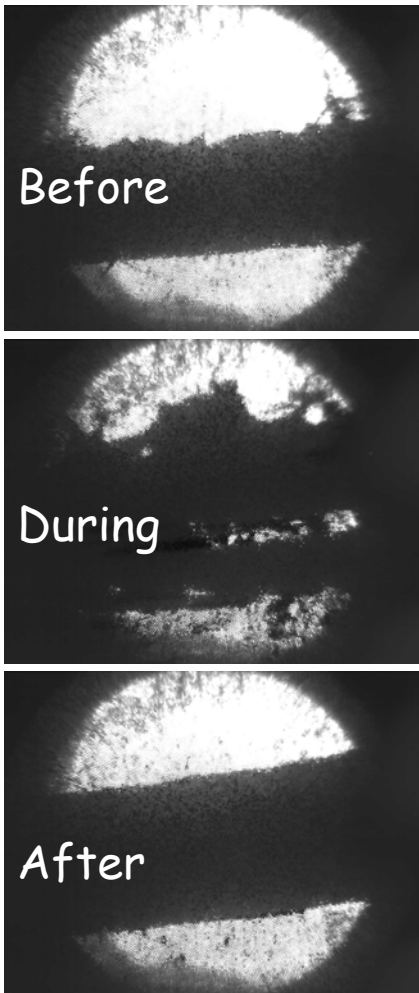

Disruption length never longer than region of overlap of jet with proton beam.

No disruption for pulses of  $< 2 T_p$  in 0 T ( $< 4 T_p$  in 10 T).

Disruption length shorter at higher magnetic field.



# Filament Velocity Analysis (H. Park)

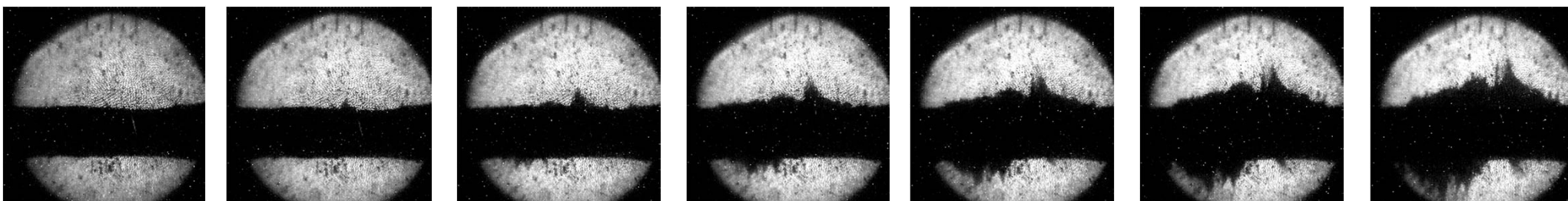

Measure position of tip of filament in each frame, and fit for  $t_v$  and  $v$ .

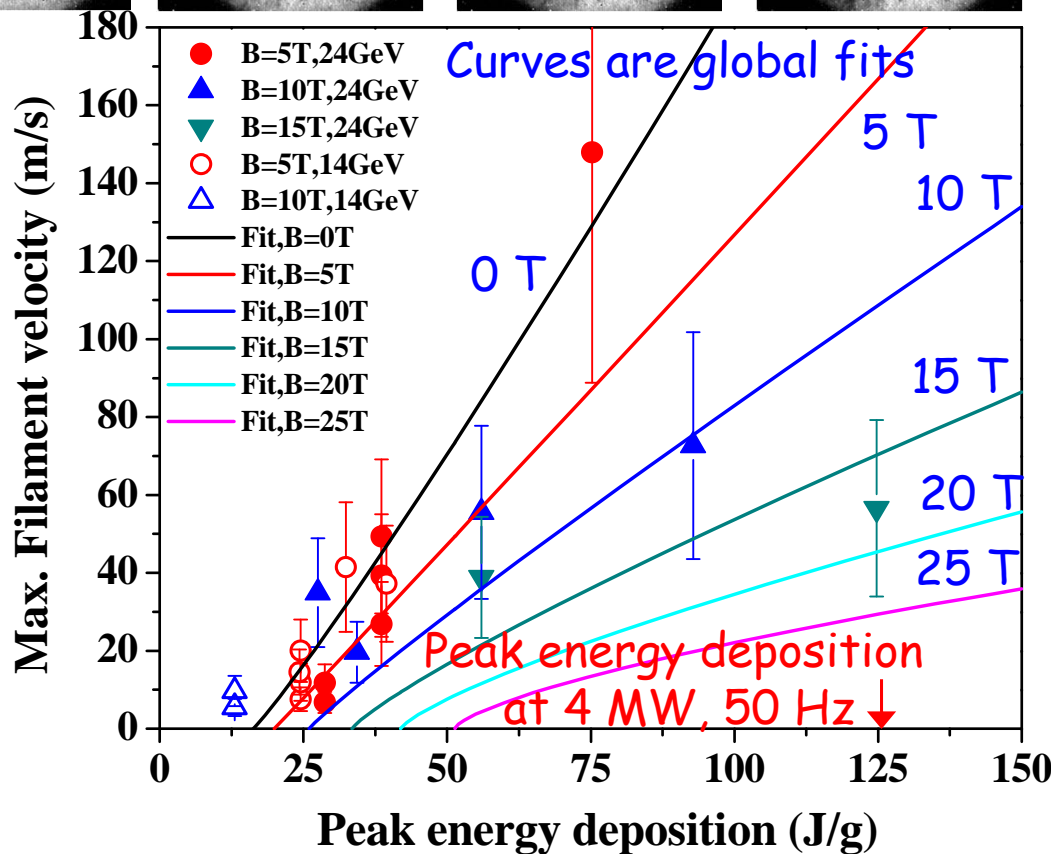
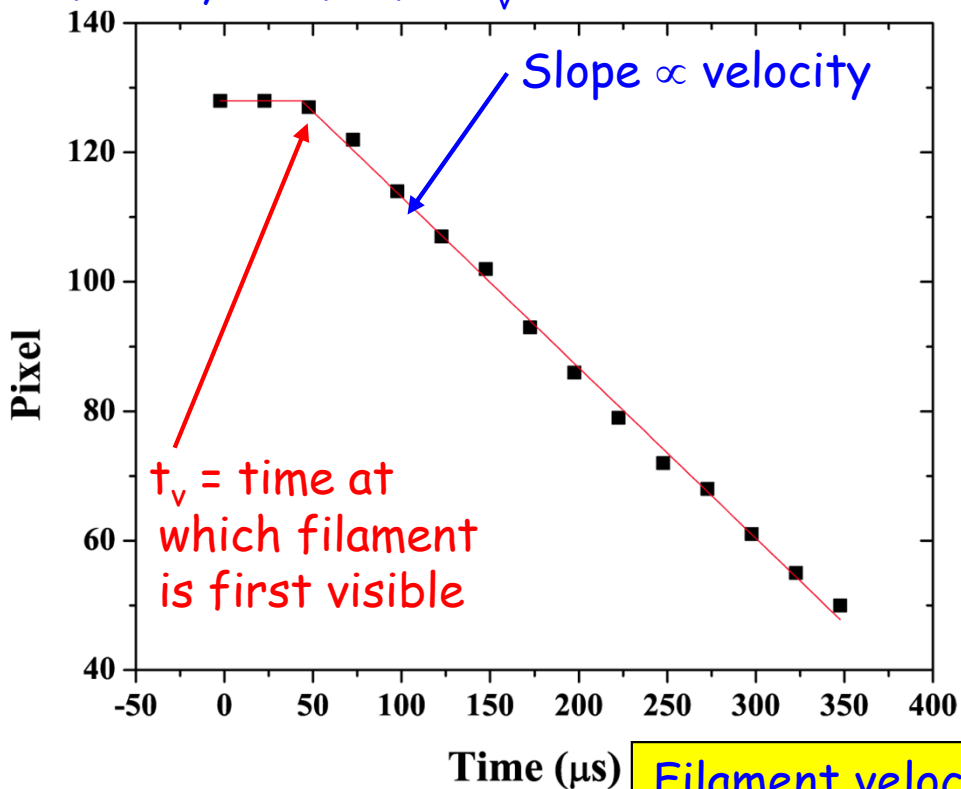

Filament velocity suppressed by high magnetic field.  
 Filament start time  $\gg$  transit time of sound across the jet.  
 $\Rightarrow$  New transient state of matter???



# Pump-Probe Studies

? Is pion production reduced during later bunches due to disruption of the mercury jet by the earlier bunches?

At 14 GeV, the CERN PS could extract several bunches during one turn (pump), and then the remaining bunches at a later time (probe).

Pion production was monitored for both target-in and target-out events by a set of diamond diode detectors.

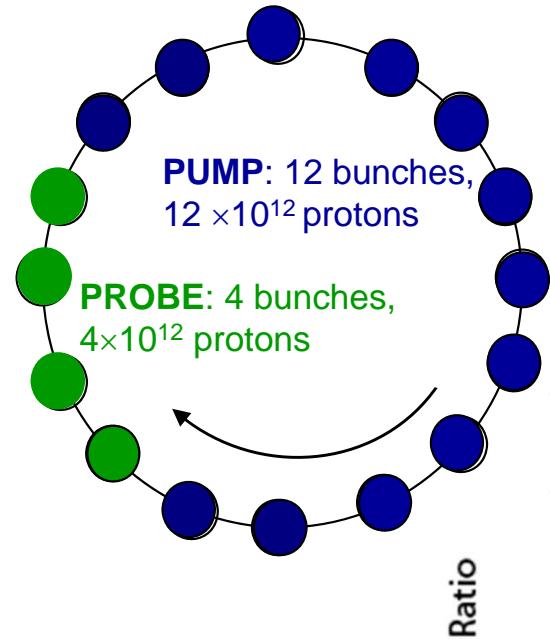

$$\text{Ratio} = \frac{\frac{\text{Probe}_{\text{target in}} - \text{Probe}_{\text{target out}}}{\text{Pump}_{\text{target in}} - \text{Pump}_{\text{target out}}}}{\frac{\text{Probe}_{\text{target out}}}{\text{Pump}_{\text{target out}}}}$$

Ratio Target In-Out/Target Out

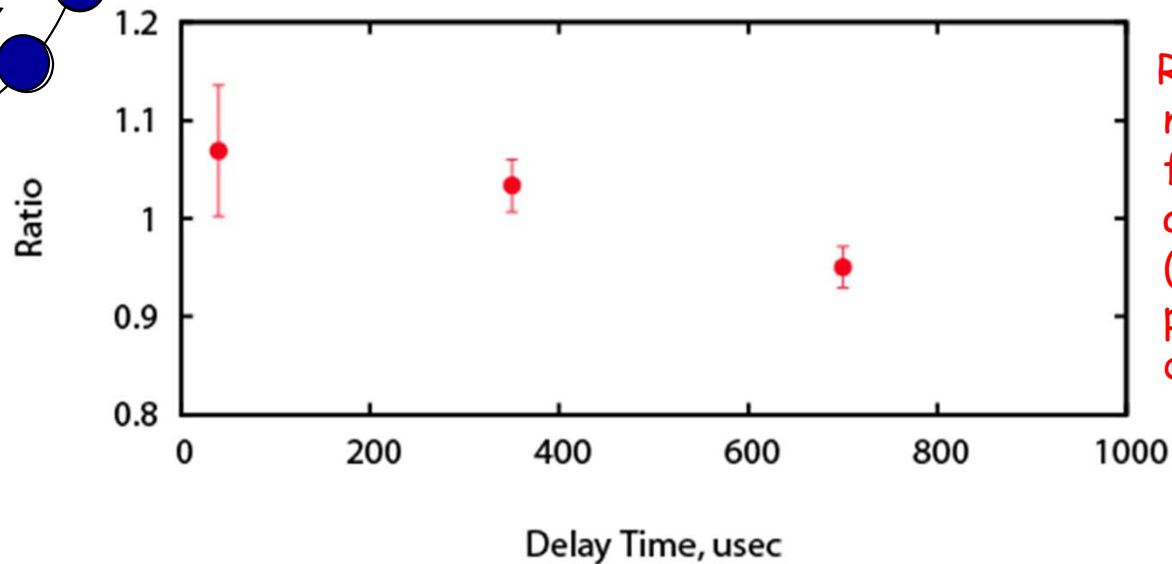

Results consistent with no loss of pion production for bunch delays of 40 and 350 μs, and a 5% loss (2.5-σ effect) of pion production for bunches delayed by 700 μs.



# Damage by Mercury Droplets?

Cavitation pitting of (untreated) SS wall surrounding Hg target after 100 pulses (SNS):

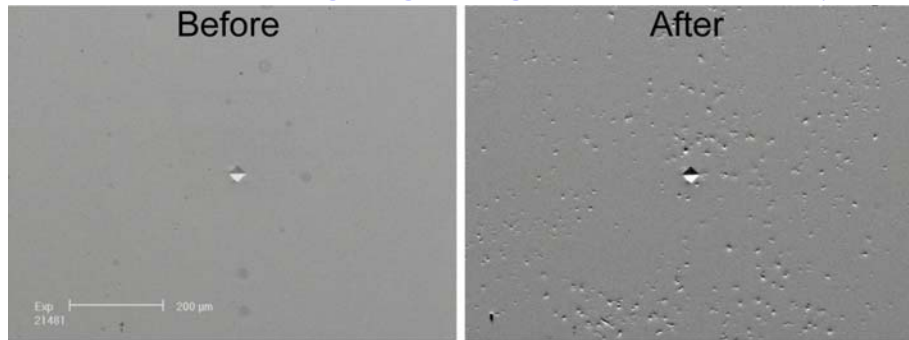

TL - High Power Target  
Specimen # 29754  
Equivalent SNS Power Level = 2.5

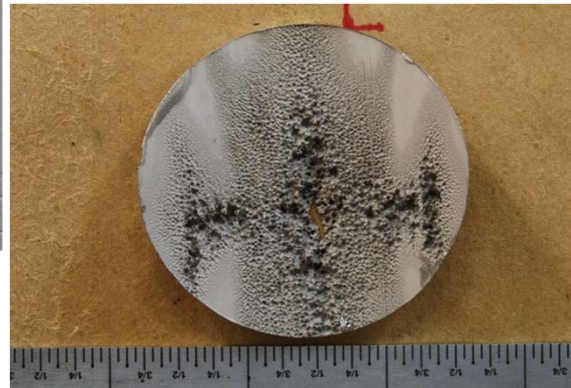

SNS Target-1  
Post mortem

Numerical model by T. Davenne (RAL) suggests that droplets can cause damage.

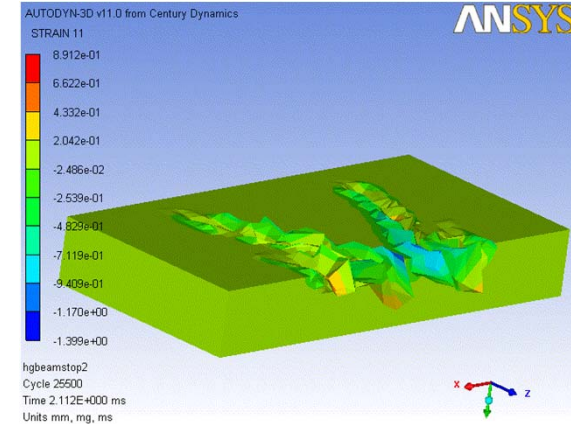

Avoid this issue with free jet. But, is damage caused by mercury droplets from jet dispersion by the beam?

Preliminary survey of MERIT primary containment vessel shows no damage.

Further studies to be made with Zeiss surface profiler.



# MERIT Experiment Summary

---

The MERIT experiment established proof-of-principle of a free mercury jet target in a strong magnetic field, with proton bunches of intensity equivalent to a 4 MW beam.

- The magnetic field stabilizes the liquid metal jet and reduces disruption by the beam.
- The length of disruption is less than the length of the beam-target interaction,  $\Rightarrow$  Feasible to have a new target every beam pulse with a modest velocity jet.
- Velocity of droplets ejected by the beam is low enough to avoid materials damage.
- The threshold for disruption is a few  $\times 10^{12}$  protons, permitting disruption-free operation at high power if can use a high-rep-rate beam.
- Even with disruption, the target remains fully useful for secondary particle production for  $\approx 300 \mu\text{s}$ , permitting use of short bunch trains at high power.
- No apparent damage to stainless-steel wall only 1 cm from interaction region.





# Overall Summary

The opportunity for a Muon Collider/Neutrino Factory is associated with many challenges.

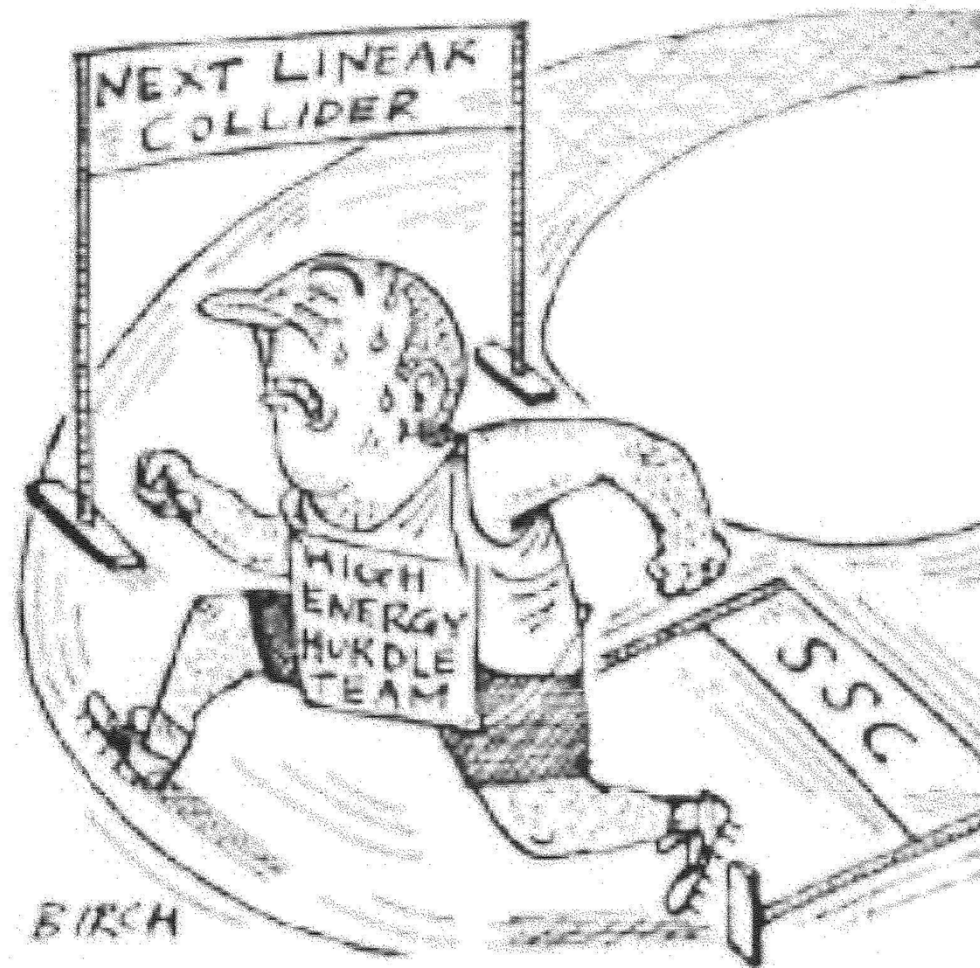

"NEUTRINO FACTORY"  
IN RACETRACK SHAPED RING...

[No pain, no gain!]



# Footnote

hep-ph/0305062  
revised, June 2003

## Destruction of Nuclear Bombs Using Ultra-High Energy Neutrino Beam

— dedicated to Professor Masatoshi Koshihara —

Hiroataka Sugawara\*

Hiroyuki Hagura†

Toshiya Sanami‡

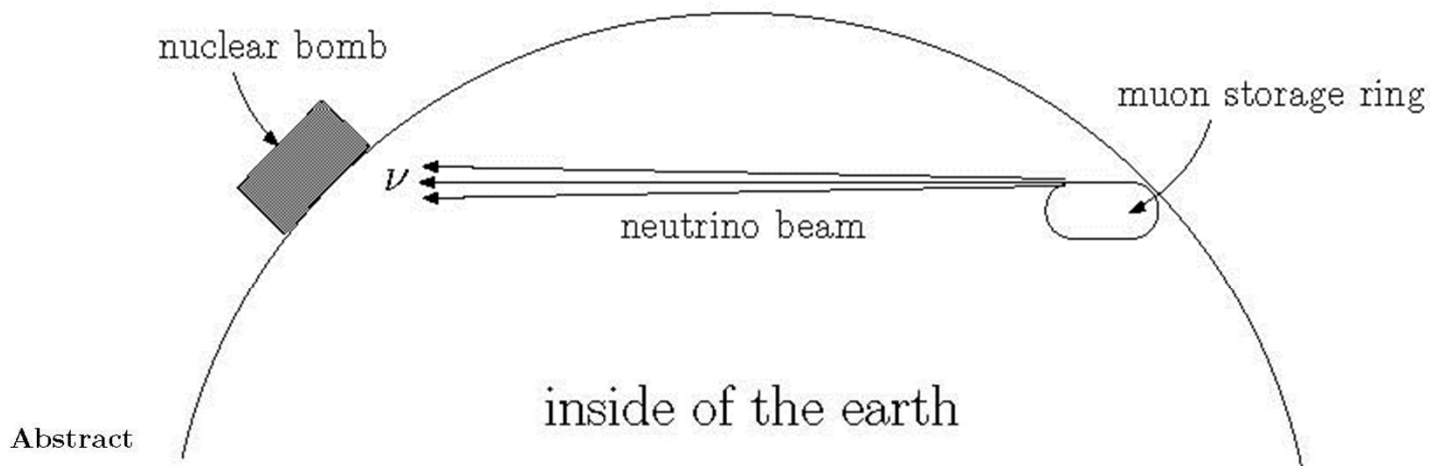

We discuss the possibility of utilizing the ultra-high energy neutrino beam ( $\simeq 1000$  TeV) to detect and destroy the nuclear bombs wherever they are and whoever possess them.

