

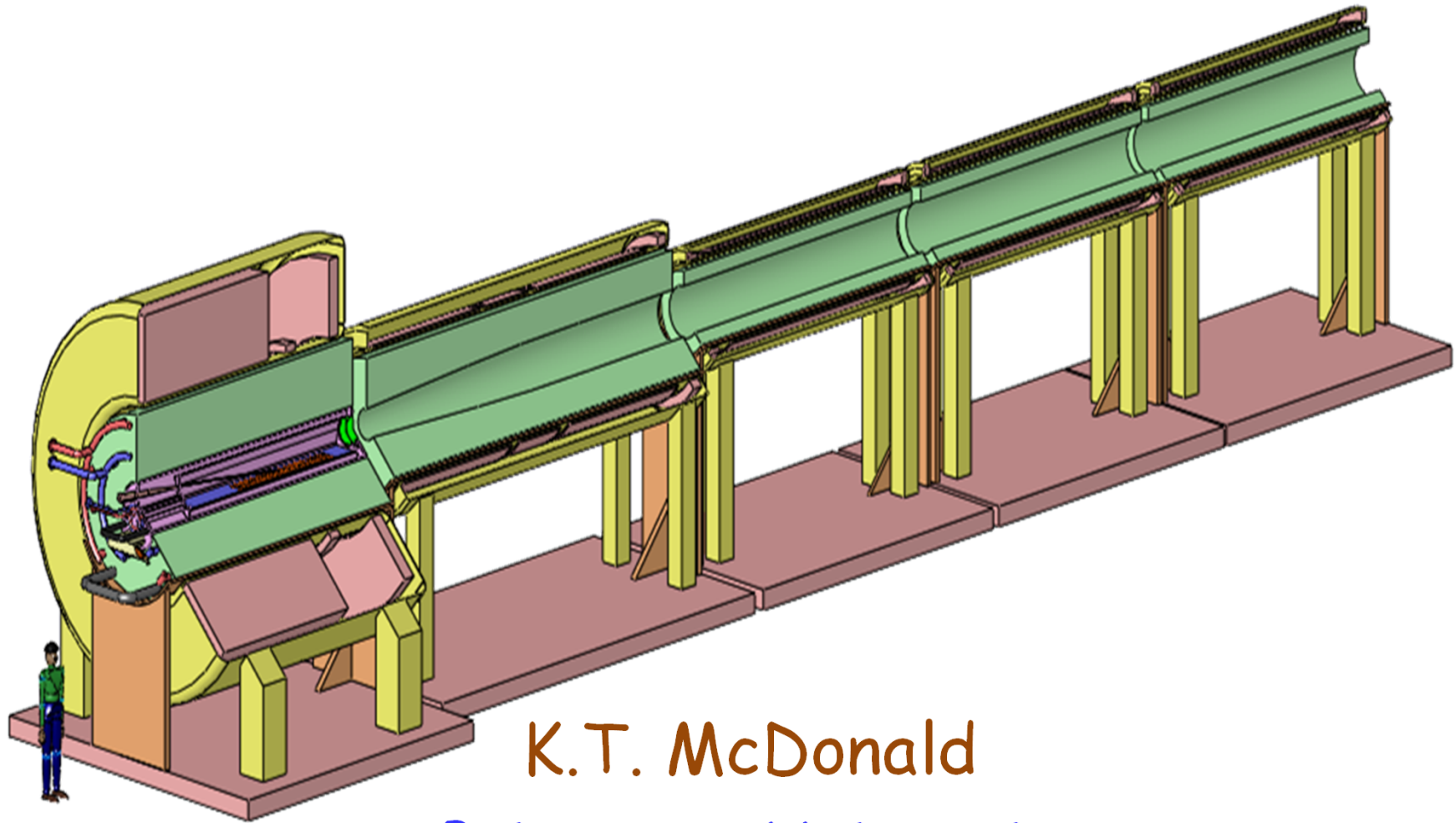

Front End - Target Options



K.T. McDonald
Princeton University
(January 7, 2014)



Target System Challenges



A target costs "\$1", but a high-power Target System costs a significant fraction of \$1B.

Muon Colliders and Neutrino Factories need a copious source of muons, from decay of pions produced by the interaction of a proton beam with a target.

Pions so produced are most numerous with KE ~ 100 MeV.

They have $\langle P_{\perp} \rangle \approx 250 \text{ MeV}/c$, \Rightarrow Large angles.

High-Z targets are favored.

The proton beam is pulsed at $\approx 50 \text{ Hz}$, and has 1-4 MW average power.

The Target System must dissipate this power.

Both signs of π/μ are desired simultaneously.

Nueffer (1981) considered (toroidal-field) Li lenses, \Rightarrow 2 target stations to collect both signs.

http://puhep1.princeton.edu/~mcdonald/examples/accel/neuffer_ieetns_28_2034_81.pdf

Fernow *et al.* reviewed options in 1995: Li lenses, plasma lenses, toroidal horns, and solenoidal capture.,

http://puhep1.princeton.edu/~mcdonald/examples/accel/fernow_aipcp_352_134_95.pdf

All of the pulsed, toroidal systems would be well beyond present technology (then and now!), so the solenoid capture system began to be favored.

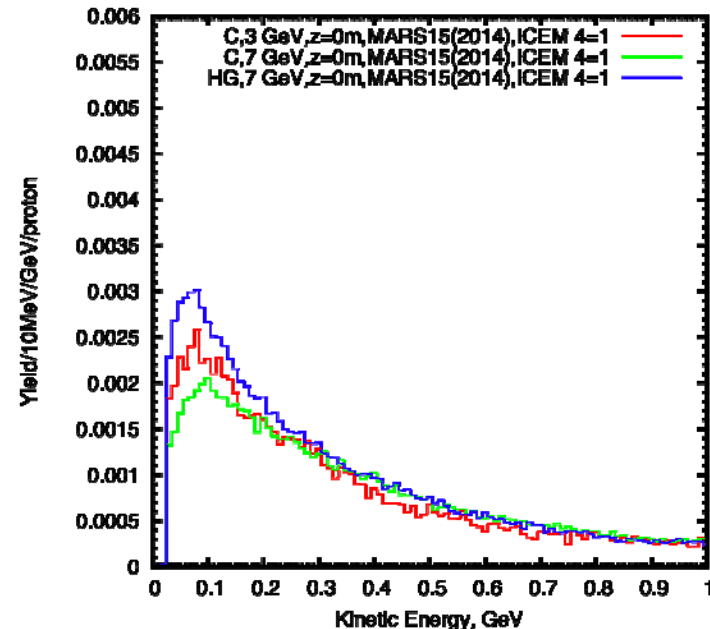



Target System Challenges II



A high-field (B_i) capture solenoid with downstream field tapering to a lower value B_f improves the transverse acceptance (for particles produced in a target at $R \approx 0$).

Magnetic flux $\Phi = \pi R^2 B = \frac{\pi c}{e} R P_{\perp} = \pi c^2 P_{\perp}^2 / e^2 B$ is an adiabatic invariant, where the helix radius is $R = c P_{\perp} / e B$,

$\Rightarrow P_{\perp f} = P_{\perp i} \sqrt{B_f / B_i}$, so for a given final aperture R_f and final field B_f , can capture $P_{\perp f} \propto R_f B_f$,

and hence capture $P_{\perp i} \propto R_f B_f \sqrt{B_i / B_f}$, which is larger if $B_i > B_f$.

$P_{\perp f} < P_{\perp i}$, and so $P_{\parallel f} > P_{\parallel i}$ (since P is constant in a B field), which may decrease the longitudinal acceptance.

While the extent in transverse phase space of particles produced in a line target is zero, the rms transverse emittance has apparent growth with z until $\epsilon_{\perp} = \sigma_{\perp} \sigma_{p_{\perp}} / m_{\pi} \approx e B R^2 / 2 m_{\pi} c$, which effective emittance is unaffected by the taper from B_i to B_f .

However, the taper increases the number of particles within this transverse emittance, and so provides a kind of "transverse cooling."

The option of a mercury jet target may have been first considered by Palmer *et al.* in late 1995,

http://puhep1.princeton.edu/~mcdonald/examples/accel/palmer_aipcp_372_3_96.pdf

A radiation-cooled graphite target was the baseline for the 1.5-MW Neutrino Factory Study I (2001),

http://www.fnal.gov/projects/muon_collider/nu-factory/

A graphite target suffers from radiation damage and needs to be replaced every 4-6 weeks @ 1 MW (7-10 days @ 4 MW).

The issue of radiation damage to superconductors was appreciated early on, but use of MARS without the MCNP data significantly underestimated damage due to low-energy neutrons.

The solenoid beam transport captures $\approx 10\%$ of the beam power (mostly scattered protons) which must be dissipated downstream of the nominal Target System.

\Rightarrow The Decay Channel is conceptually part of the Target System, using similar technology for magnets and shielding.



Target and Capture Topology: Solenoid

Desire $\approx 10^{14}$ μ/s from $\approx 10^{15}$ p/s (≈ 4 MW proton beam).

R.B. Palmer (BNL, 1995) proposed a 20-T solenoidal capture system.

Low-energy π 's collected from side of long, thin cylindrical target.

Solenoid coils can be some distance from proton beam.

$\Rightarrow \geq 10$ -year life against radiation damage at 4 MW, with sufficient shielding.

Liquid mercury jet target replaced every pulse (or graphite target replaced often).

Proton beam readily tilted with respect to magnetic axis.

\Rightarrow Beam dump (mercury pool) out of the way of secondary π 's and μ 's (or additional graphite block as beam dump).

IDS-NF Target Concept:

Tungsten beads,
He gas cooled

Proton beam and
Mercury jet

Resistive magnets
Mercury collection pool
With splash mitigator

Superconducting magnets

Be window

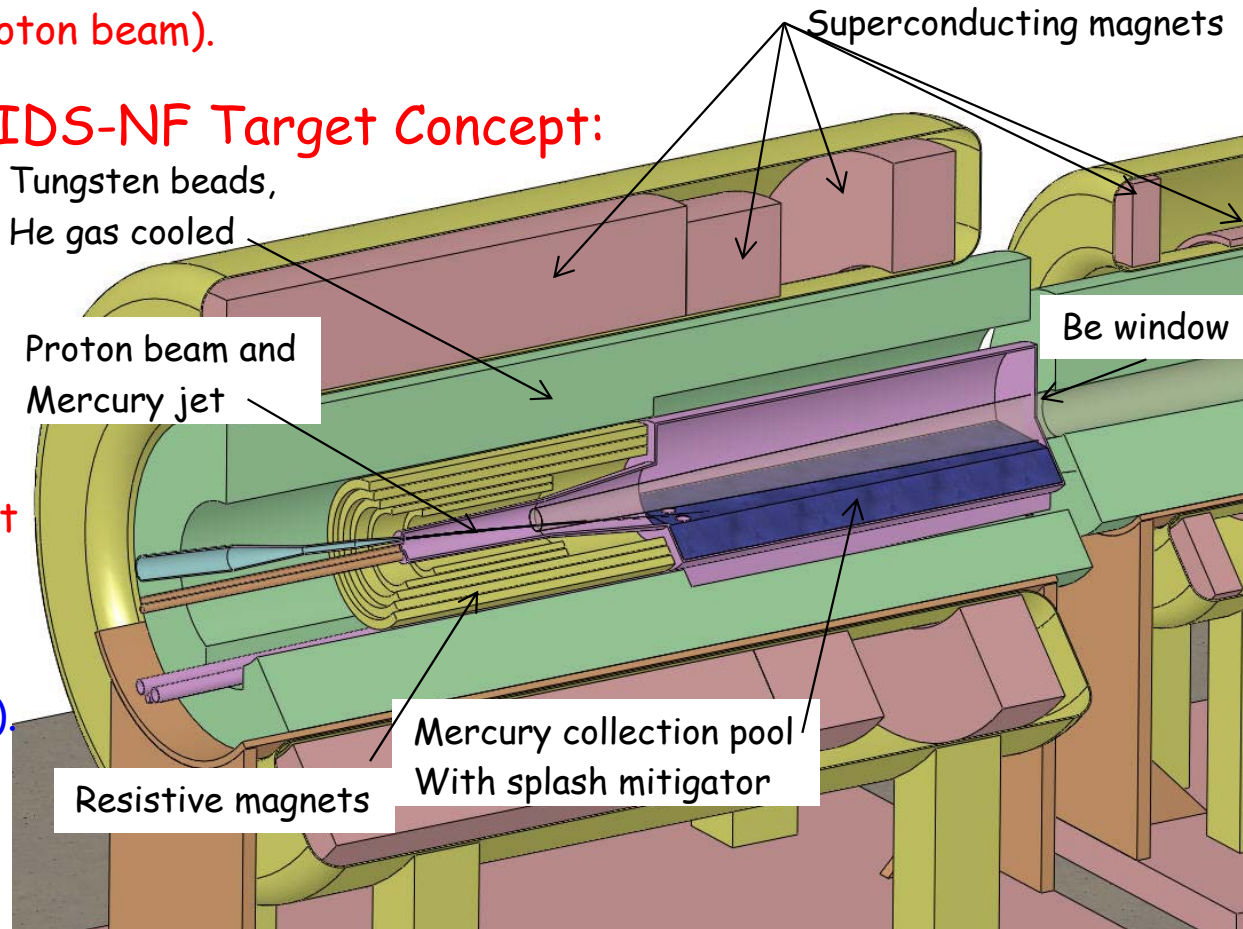

Shielding of the superconducting magnets from radiation is a major issue.

Magnetic stored energy ~ 3 GJ!

5-T copper magnet insert; 15-T Nb_3Sn coil + 5-T NbTi outsert.

If mercury target, desirable to replace the copper magnet by a 20-T HTC insert (or use only 15-T Nb coil).



Large Cable-in-Conduit Superconducting Magnets



Central Solenoid (CS) Model Coil

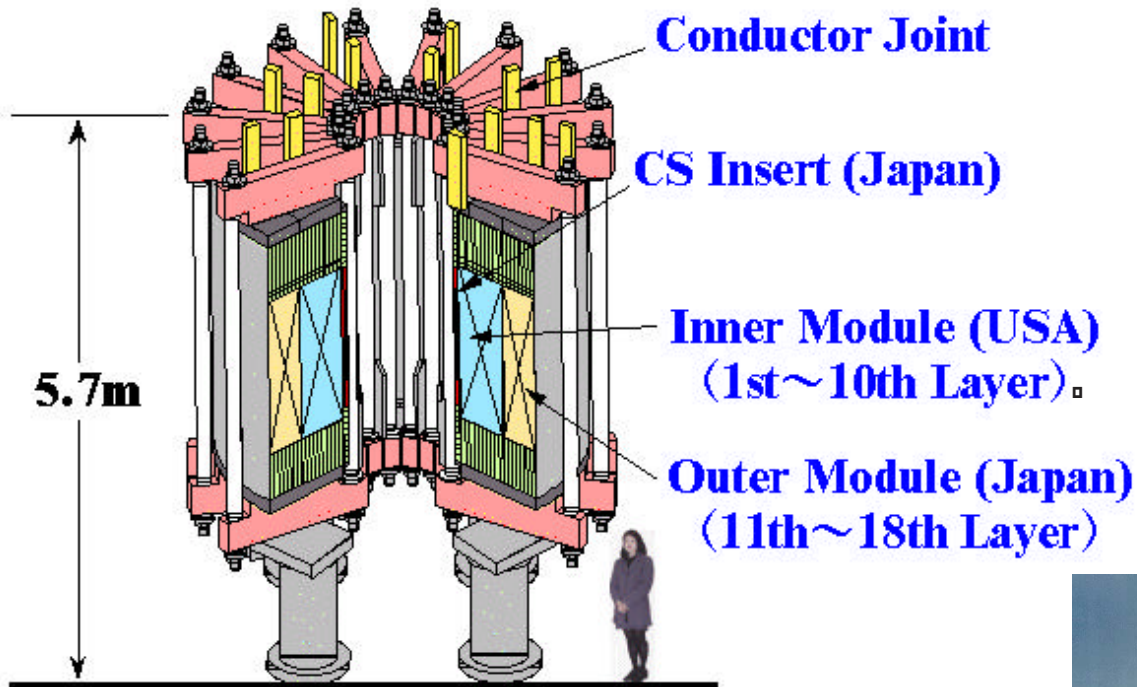

The high heat load of the target magnet requires Nb₃Sn cable-in-conduit technology, more familiar in the fusion energy community than in high energy physics.

The conductor is stabilized by copper, as the temperatures during conductor fabrication comes close to the melting point of aluminum.

The conductor jacket is stainless steel, due to the high magnetic stresses.

A high-temperature superconducting insert of 6+ T is appealing - but its inner radius would also have to be large to permit shielding against radiation damage.

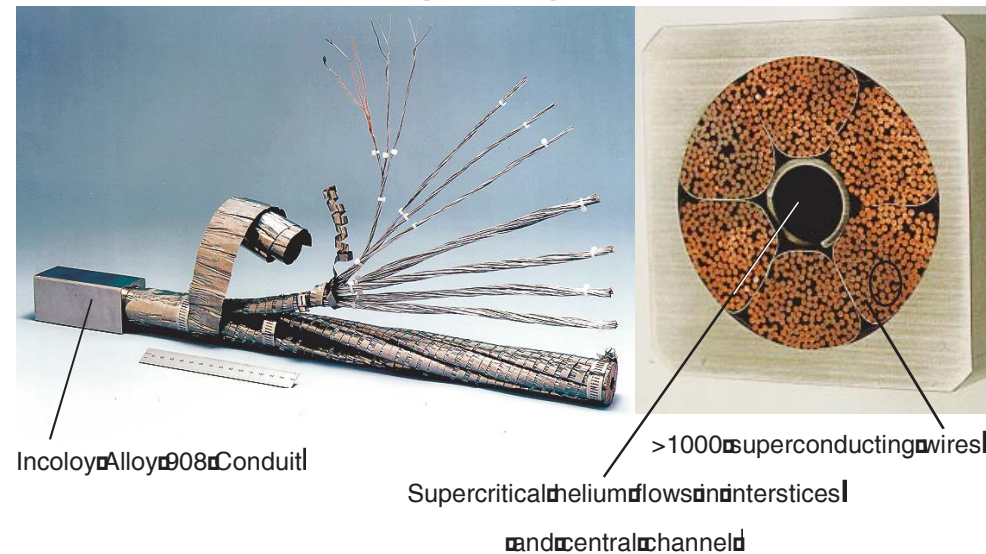



Copper Conductor for Radiation-Resistant Magnets



Organic insulation cannot be used in copper coils in the Target System (or Decay Channel).

Radiation-resistant conductor with MgO (or spinel) insulation has been developed at KEK/JHF.

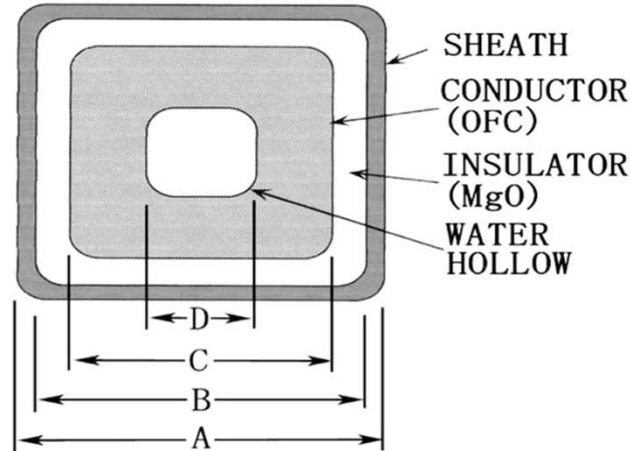
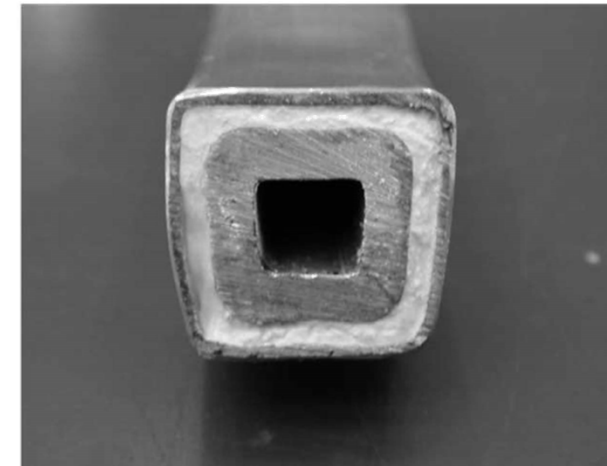

TABLE I
PARAMETERS OF Q440MIC TYPE Q-MAGNET

Magnet length:	2000 mm
Magnet bore diameter:	200 mm
Magnet weight:	33000 kg
Nominal current:	2200 A
Nominal voltage:	200 V
Nominal water pressure drop:	1.0 MPa
Required cooling water:	290 liter/min.
Cooling water temp. rise:	30 deg. centigrade
Field at pole:	1.3 tesla

Nominal Current (A)	2000	2500	3000	1000*	
2000*					
Dimensions (mm)					
A: Outward Size	20.0	23.8	28.0	18.0	14.0
B: Insulator Size	18.0	21.6	25.0	16.6	12.6
C: Conductor Size	14.6	18.0	20.0	13.2	9.2
Cross Sections (mm ²)					
Conductor	150.9	211.7	293.1	168.4	78.8
Insulator	117.7	153.2	227.4	106.6	79.4
Sheath	73.4	95.3	150.6	47.8	36.6

*indicates Solid Conductor MICs. No hollow is in Cu conductor.



402

IEEE TRANSACTIONS ON APPLIED SUPERCONDUCTIVITY, VOL. 14, NO. 2, JUNE 2004

Development of Radiation Resistant Magnets for JHF/J-PARC

K. H. Tanaka, E. Hirose, H. Takahashi, K. Agari, A. Toyoda, Y. Sato, M. Minakawa, H. Noumi, Y. Yamanoi, M. Ieiri, Y. Katoh, Y. Yamada, Y. Suzuki, M. Takasaki, T. Birumachi, S. Tsukada, Y. Saitoh, N. Saitoh, K. Yahata, K. Kato, and H. Tanaka



Recent Targetry Efforts



Xiaoping Ding (UCLA) *Particle-Production Simulations* (including comparison of C and Ga with Hg)

Ole Hansen (CERN) *Target Optimization*

Hisham Sayed (BNL) *Configurations with shorter taper* (matched to phase rotator)

Bob Weggel (MORE/PBL) *Magnet and Shielding Configurations*

Nicholas Souchlas (PBL) *Energy-deposition simulations for the Target System* (to determine whether the superconducting magnets are sufficiently well shielded from the 4-MW beam power)

Pavel Snopok (IIT) *Energy-deposition simulations for the Decay Channel* (soon N. Souchlas)

Van Graves (ORNL) *Mercury module design + overall Target System layout*

Yan Zhan (Stony Brook) *Nozzle and Jet Studies* (towards improving the jet quality)

Roman Samulyak (Stony Brook) *MHD Simulations* (including beam-jet interactions)



Particle Production Simulations

Xiaoping Ding (UCLA)



Extensive simulations using MARS15 showed that with a high-Z target, particle production peaks around 6-7 GeV, and that it is favored to use a long, thin target, tilted with respect to the magnetic axis (and tilted proton beam).

MARS15(2012) indicated that for 3-GeV proton beam, carbon is better than Hg (but MARS15(2012) has issues in the range 3-10 GeV).

MARS15(2014) just released, and indicates reduced production by high-Z targets, but Hg still favored over C at 7 GeV.

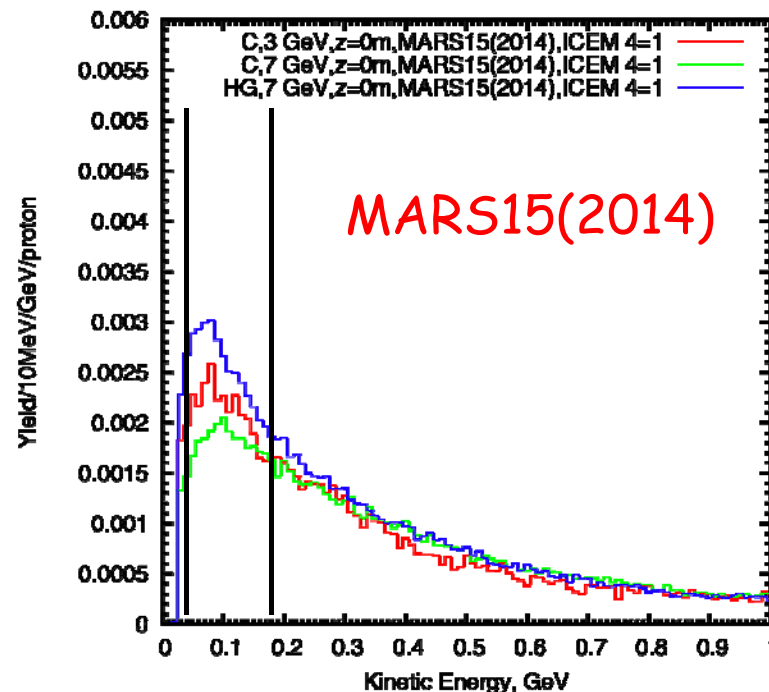
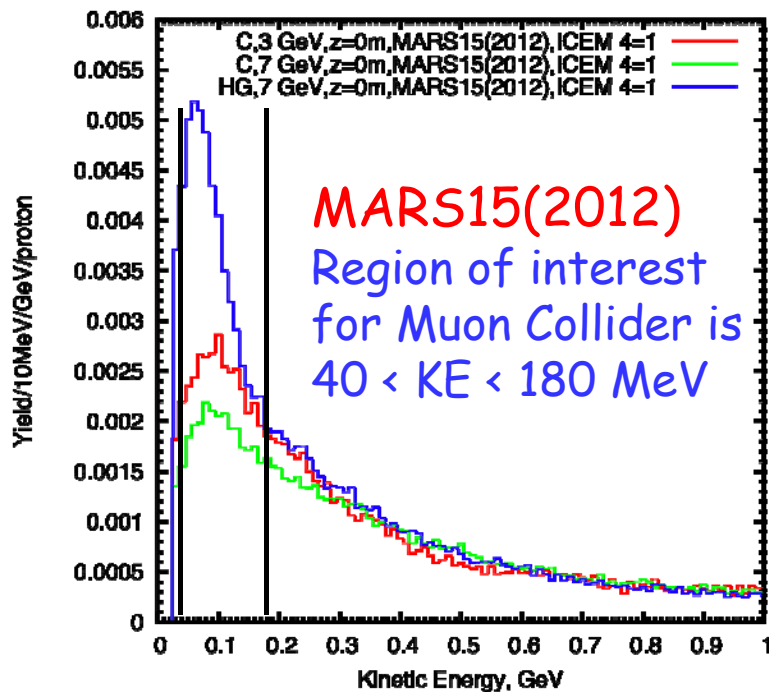
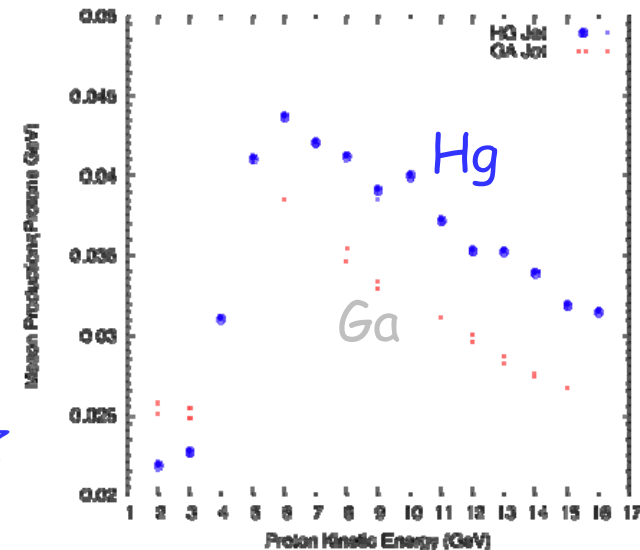



Configurations with a Shorter Taper

Hisham Sayed (BNL)



Following a hint from O. Hansen, the yield of useful muons out of the Phase Rotator (Front End), is improved by shifting the timing of the proton beam, and shortening the length of the taper between 20/15 T and 1.5/3.5 T.

It is favorable to increase the field B_f in the Front End above the baseline of 1.5 T:

The baseline taper length of 15 m could be reduced to ~ 5 m.

Reducing the peak field B_i from 20 T to 15 T is viable, particularly if B_f is increased.

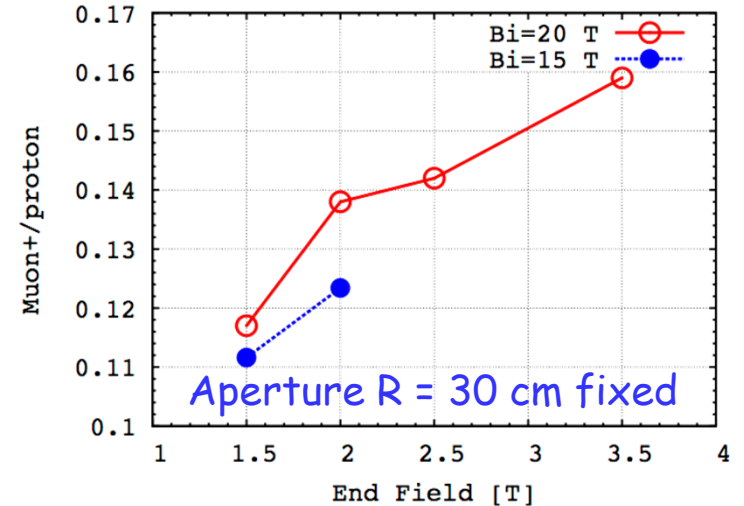
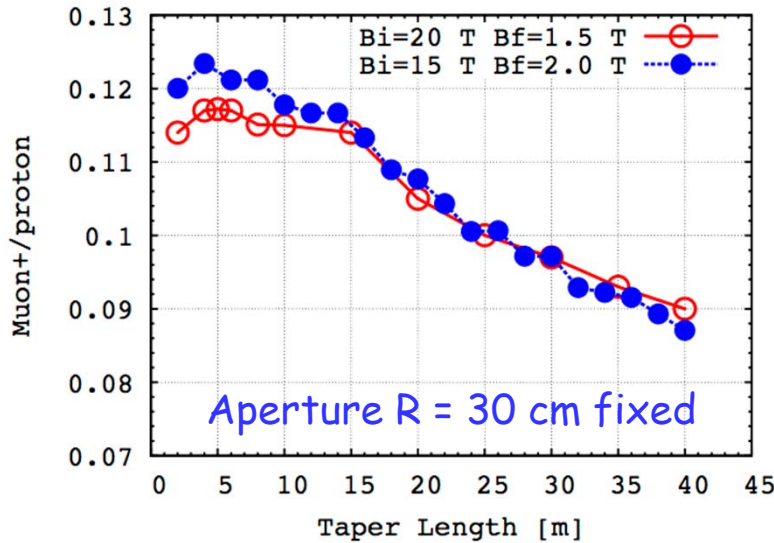

The shorter taper results in a denser distribution in longitudinal phase space, which is preferable for the Buncher/Phase Rotator.

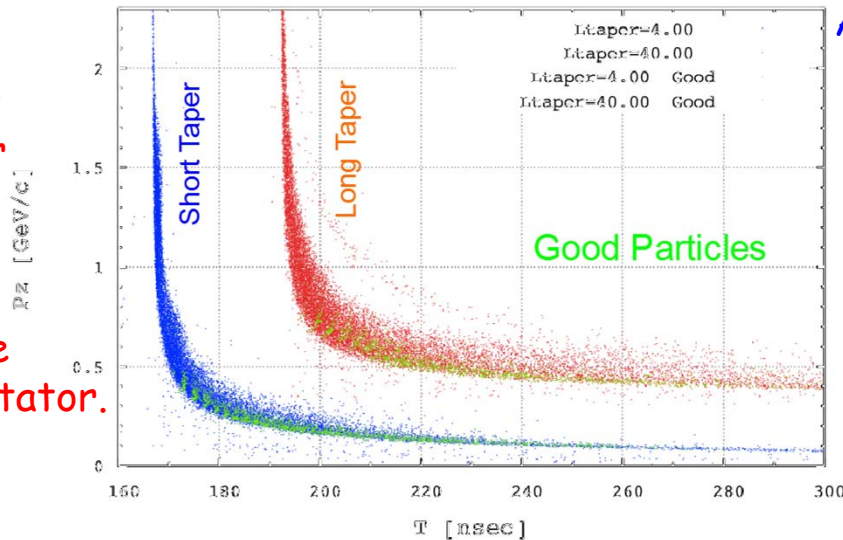

A short proton bunch continues to be favored:

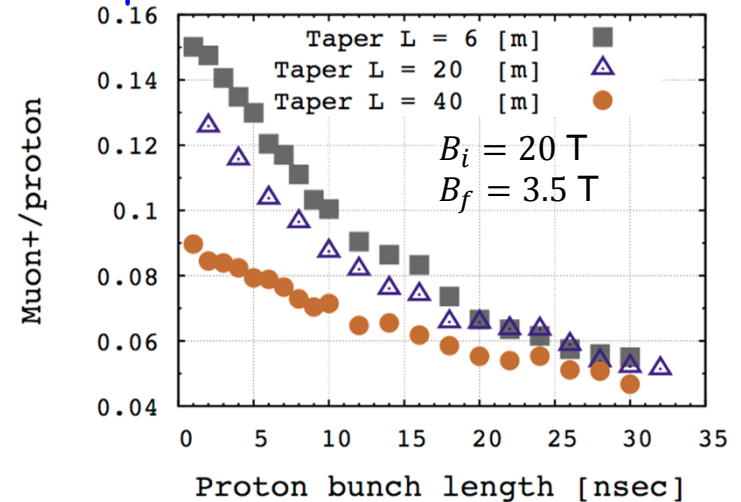



Magnet Coil Configurations

Bob Weggel (MORE/PBL)

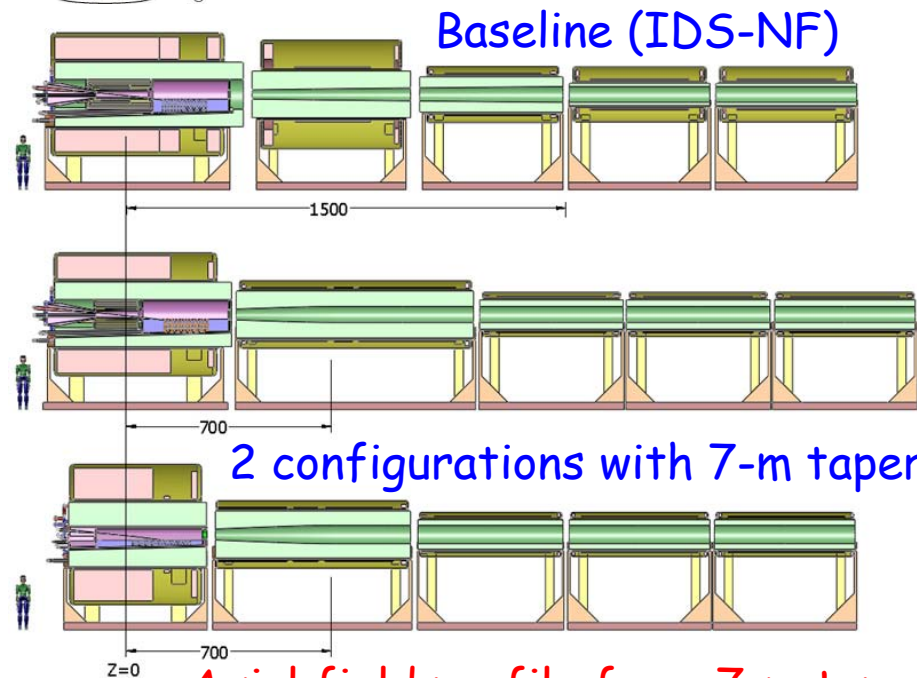

Field perturbations at the ends of the 5-m-long Decay Channel magnets can lead to "stop bands."

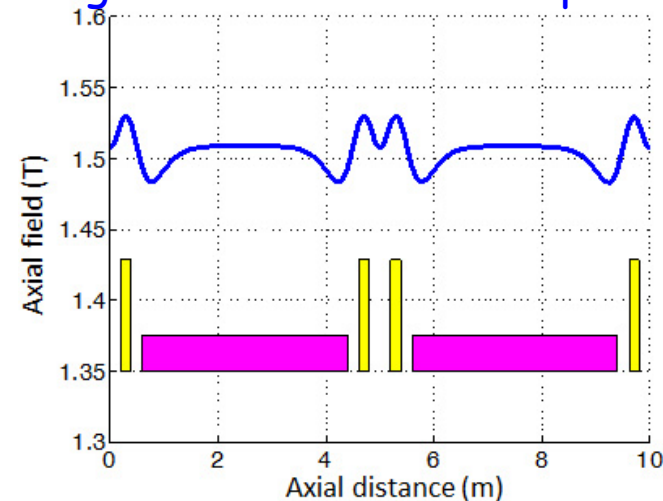

2 configurations with 7-m taper and 15-T peak

Axial field profile for a 7-m taper:

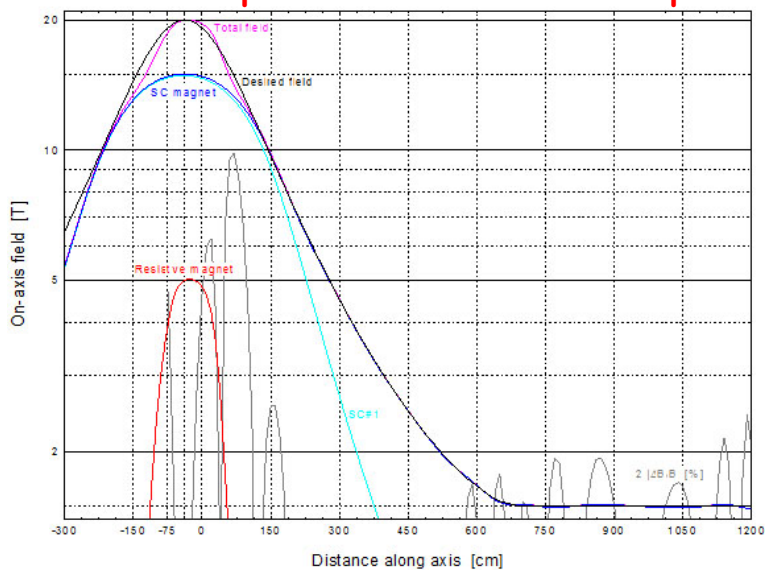

Revised coil configuration has essentially no "stop bands" (H. Sayed):

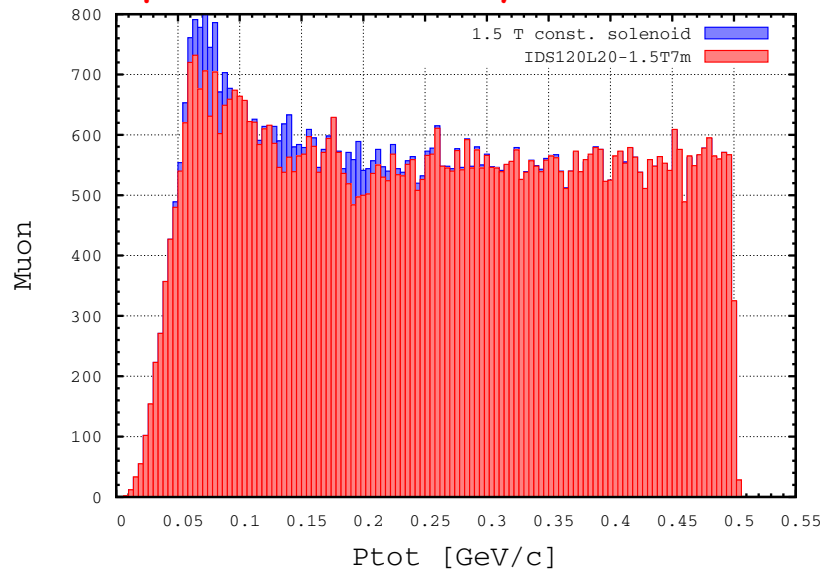

Possibly noncircular target module could lead to "hot spots" in downstream coils.

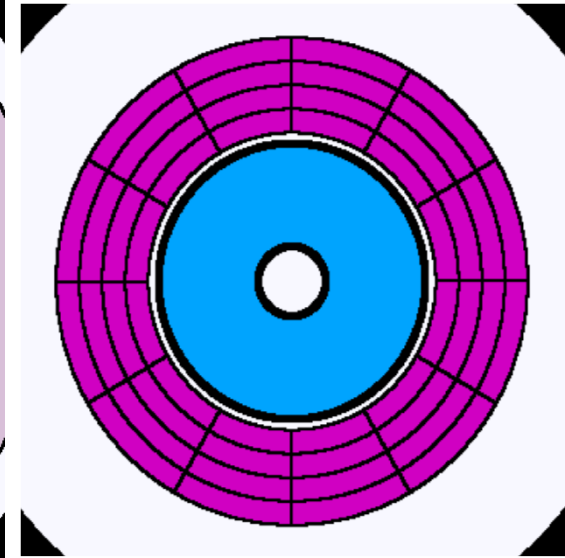
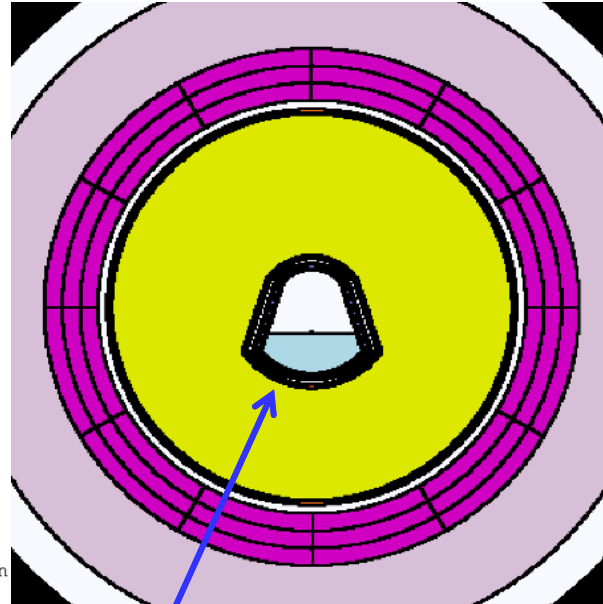
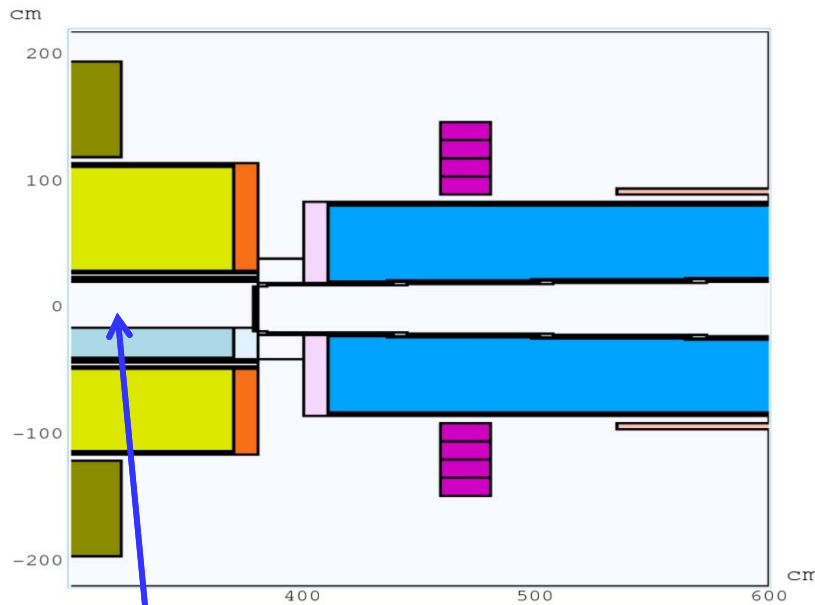

Bell-shaped mercury target module

$z = 0$

$z = 4.7 \text{ m}$

MARS15 simulations (with MCNP data files) are used to suggest changes in the W-bead shielding to keep the power deposition below 0.1 mW/g in superconducting coils (ITER limit), as needed to provide a 10-year operation lifetime against radiation damage.

http://puhep1.princeton.edu/~mcdonald/examples/magnets/schultz_ieesfe_423_03.pdf

These simulations are very time consuming, \Rightarrow Run MARS at NERSC (N. Mokhov, R. Ryne), but need the MCNP data tables for this.



Mercury Target Module Design

Van Graves (ORNL)



Insertion/
extraction
of the
Mercury
Module:

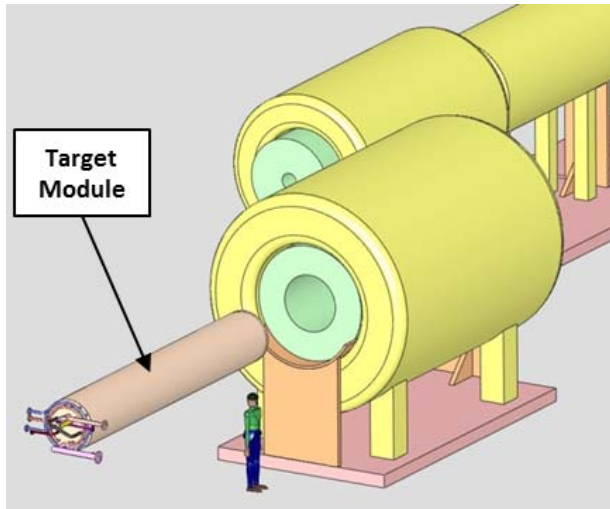

Cross
sections
of the
Mercury
Modules
for 20 T
and 15 T:

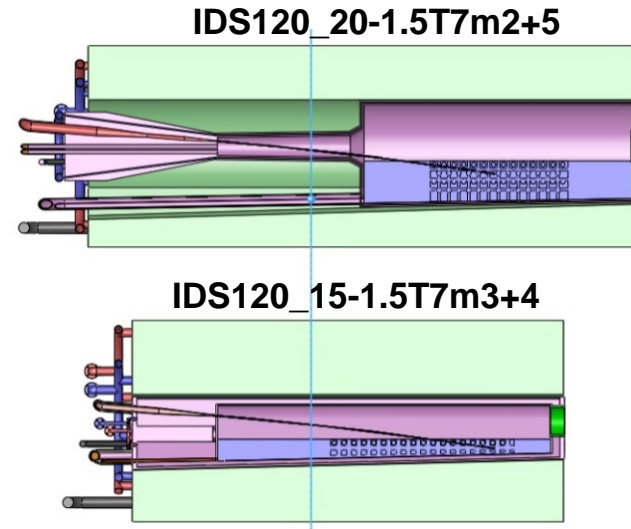

The mercury
flow loop:

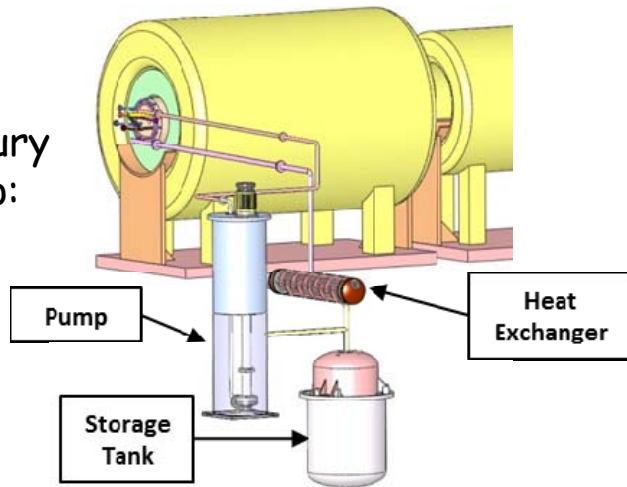

Services
for the
Mercury
Module
and the
Shielding
Module:

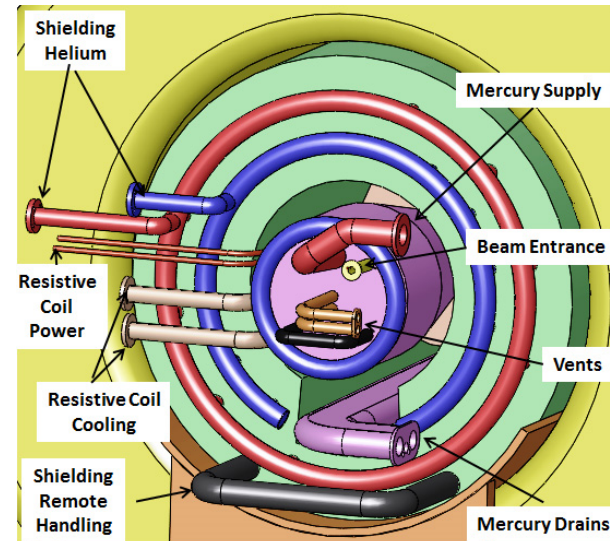

The mercury module shown above could be replaced by a carbon-target module in the initial stages of a Muon Collider/Neutrino Factory.



Mercury Nozzle Simulations

Yan Zhan (SUNY Stony Brook)



MERIT mercury jet was "elliptical," possibly due to weld beads inside the Ti nozzle.

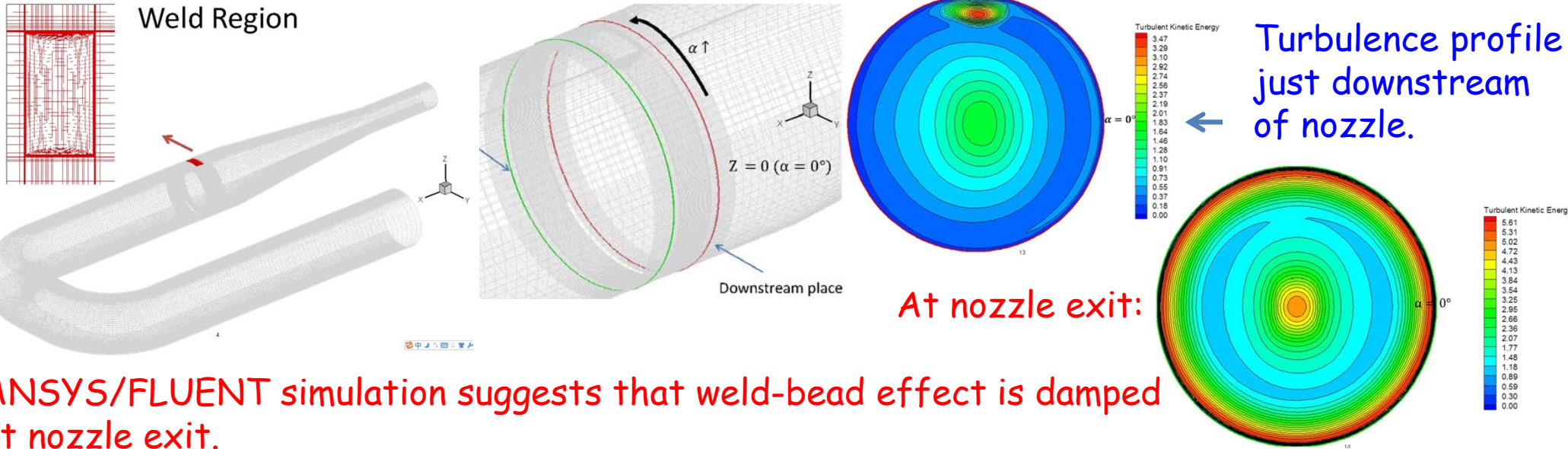

ANSYS/FLUENT simulation suggests that weld-bead effect is damped at nozzle exit.

Next: model free jet outside nozzle:

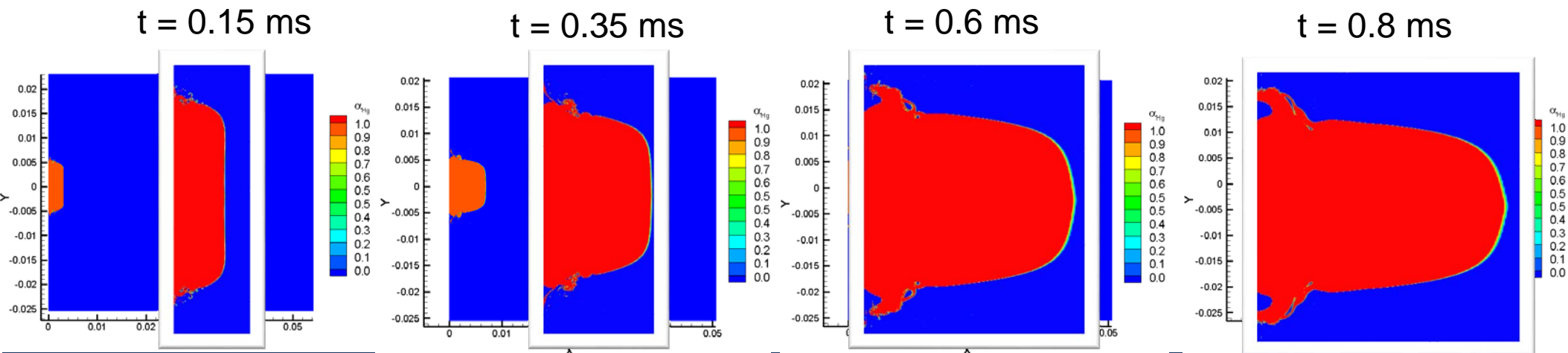

Frontier simulation of high-speed-jet cavitation and breakup:



Smoothed-Particle-Hydrodynamics simulation of MERIT beam-jet interaction:

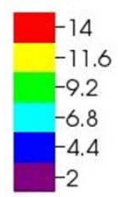
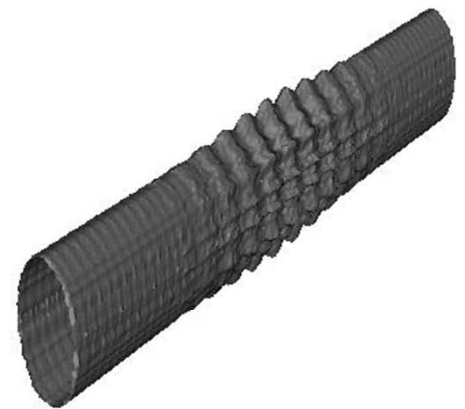

Simulation of mercury thimble experiments (2001) using the Lagrangian particle code:

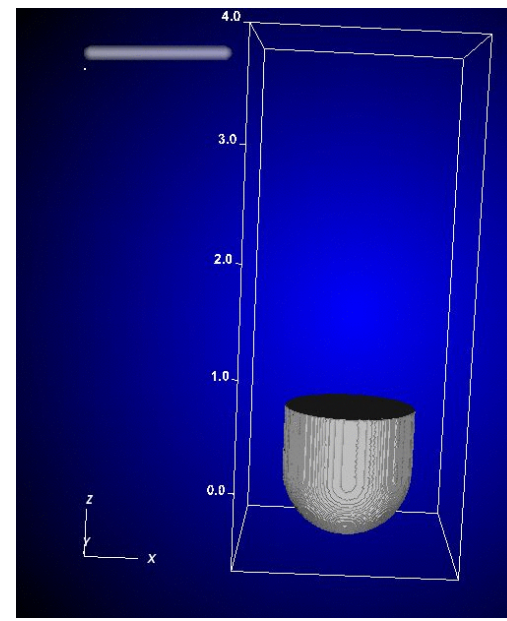



Preliminary Costing of a 4-MW Target System

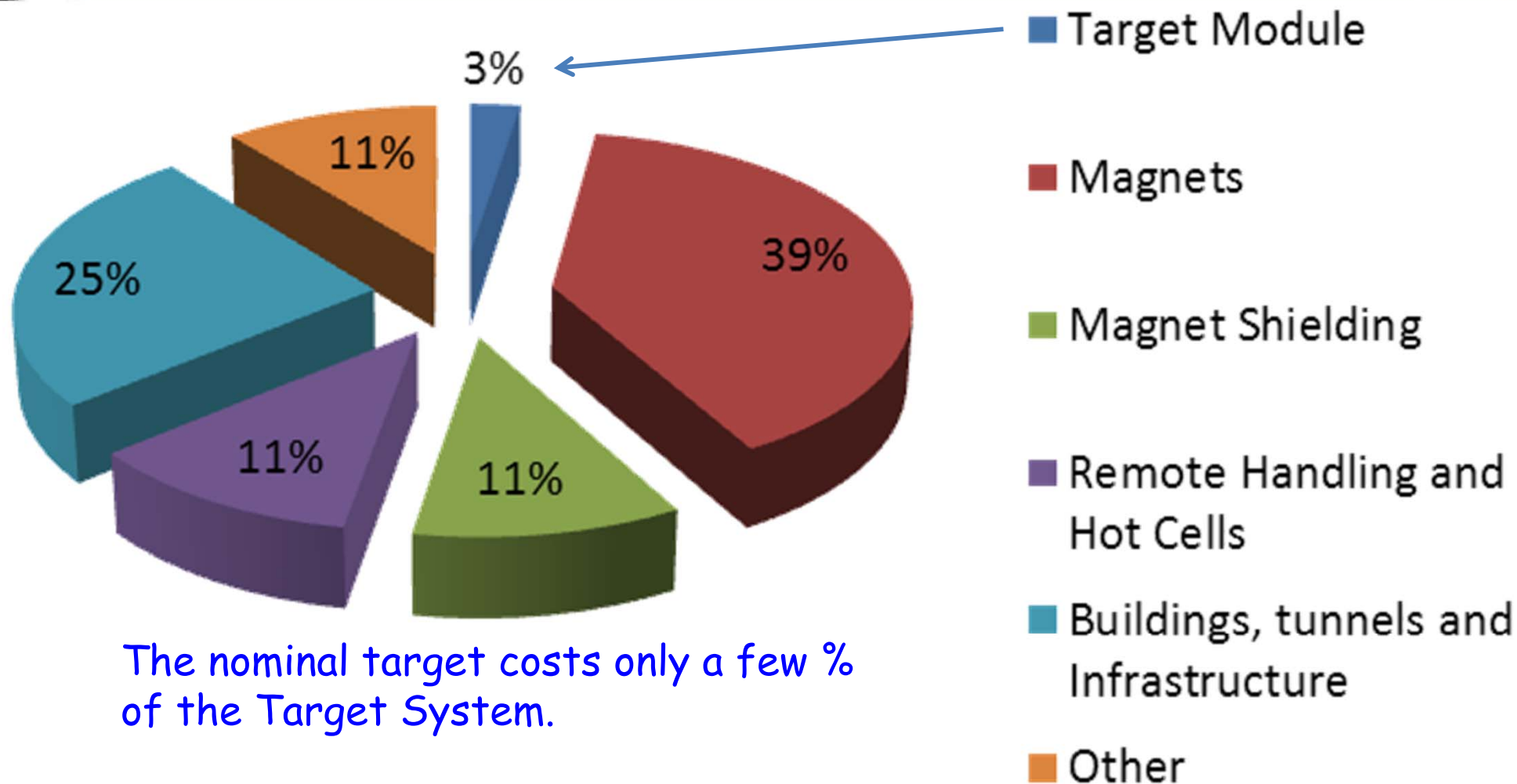

The nominal target costs only a few % of the Target System.

Infrastructure costs are ~ 50%.

(A. Kurup, International Design Study for a Neutrino Factory)



Next Steps



Past Target efforts have been part of Technology Development, in close coordination with Front End Design and Simulation.

Outstanding issues related to target technology include:

Target Module

MAP Management has preselected a carbon-target module for initial use.

This module is to have the same envelope as a possible later mercury-target module.

A carbon-target module could include a 5-T copper-coil insert, which does not fit well in a mercury-target module. (This would compensate somewhat for the lower muon yield from a carbon target at 7 GeV.)

Beam Dump

The Beam Dump is part of the Target Module. A graphite target would be followed by a graphite beam dump (while a mercury target is followed by a mercury-pool beam dump).

Capture Solenoid (+ downstream Taper)

The 15/20-T coil configuration couples to that in the Taper, which is still under study.

The Taper ends with the same aperture as that of the Phase Rotator, not yet defined.

Chicane (The chicane dumps some of the beam but is not THE Beam Dump)

Can/should the chicane coils be superconducting, with internal shielding of He-gas-cooled tungsten beads?